

# Create a hologram projector: Video in 3-D

## Background

Ellen Ochoa earned her doctorate at Stanford University. She continued researching at Sandia National Laboratories and the NASA Ames Research Center. She is an inventor who created new ways to “look” at objects in outer space. Some of her inventions helped ensure that equipment was safe. Others allowed the recording of events in space by detecting objects and removing image distortion, which makes objects appear to be a different shape, not relatively straight or wavy.

In this picture, the moon is slightly distorted and appears longer than its actual shape. There are mathematical equations that can identify distortions that occur with camera lenses. Based on these equations, researchers and engineers can correct these distortions using innovative equipment, like that developed by Ellen Ochoa.

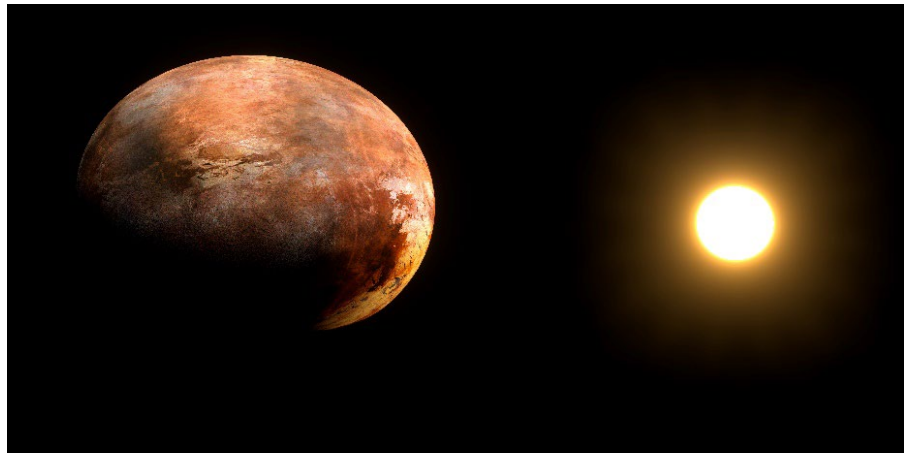

## Simplest mathematical model of distortion in a camera lens:

$r_u$  - undistorted radius

$r_d$  - distorted radius

$k$  - arctangent/tangent coefficient

$$r_u = r_d + k_1 r_d^3$$

$k_1 > 0$  for barrel distortion

$k_1 < 0$  for pincushion distortion

### Types of distortion

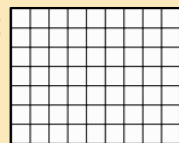

None

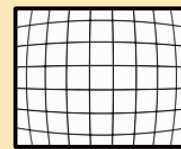

Barrel

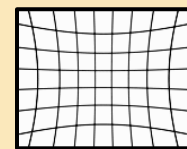

Pincushion

Ochoa's invention was based on complex mathematical equations related to the study of optics. In addition to addressing image distortion, the invention allowed the formation of a hologram by using two beams of light that enter the apparatus. Ochoa studied the principles of light, including diffraction, polarization, reflection, and refraction.

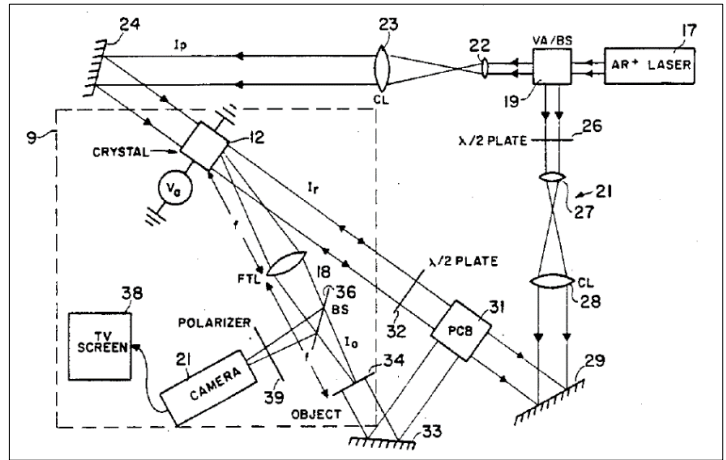

Block diagram of Ellen Ochoa's invention, System for Enhancement of Optical Features. U.S. Patent 4,674,824

### Vocabulary check

Place a check in the appropriate box in the row for each term.

Principle of light	I know what this means....	I do not know what this means...	I have heard of this...	Research, draw, and define
Distortion				
Hologram				
Beam				
Diffraction				
Polarization				
Reflection				
Refraction				

## Build a hologram projector

In this activity, you will create a hologram projector. The hologram projector is a simulation of Ellen Ochoa's optic technology. A simulation is an imitation of an actual process or method. The projector will allow the light from your device to reflect so that you can view a three-dimensional image from one of the four sides of the hologram projector.

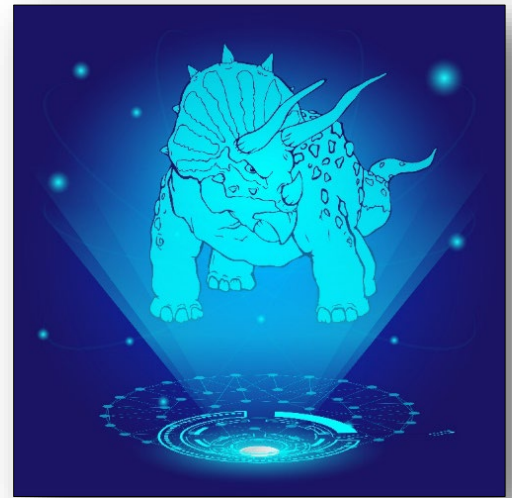

### Directions

1. To create the trapezoid template for a tablet, you need a protractor, metric ruler, and white paper.
2. Use thick plastic sheets (10 mm clear report covers) or acrylic to create a template for four trapezoid shapes with the following measurements:

#### Cell phone:

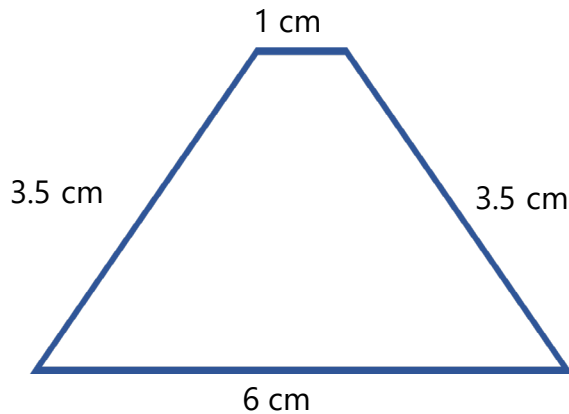

#### Tablet:

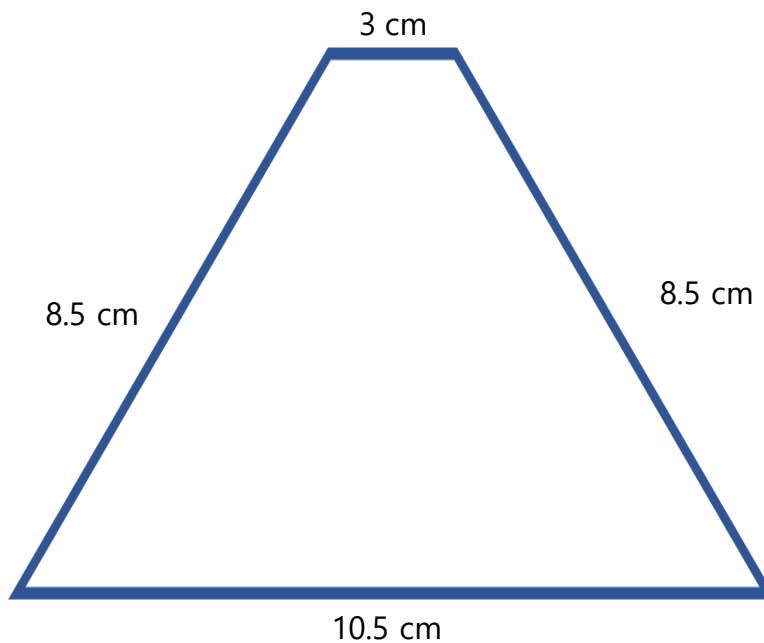

3. Measure 10.5 centimeters (6 cm if using a phone) across the bottom edge of the paper and mark with two dots, as shown below. Draw a straight line connecting the dots. Draw the line about an inch above the bottom of the paper.

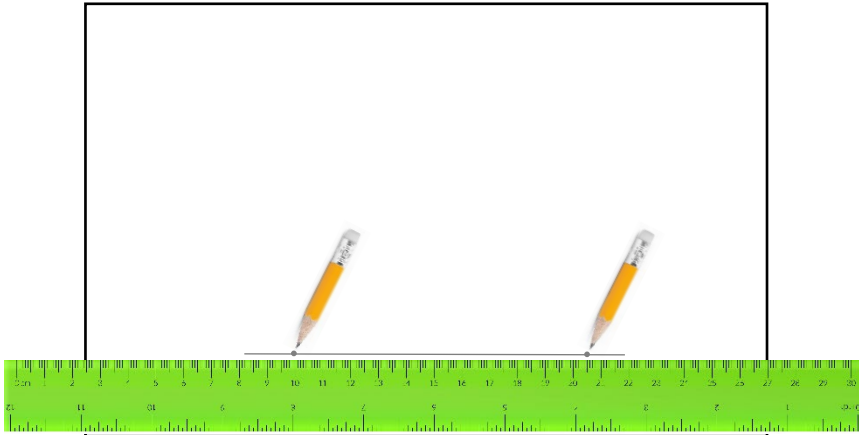

4. Place the protractor's center on the first dot of the 10.5 cm line at the bottom of the paper. Measure a  $65^\circ$  angle from the first dot and mark it with a pencil. Repeat this step with the second dot.

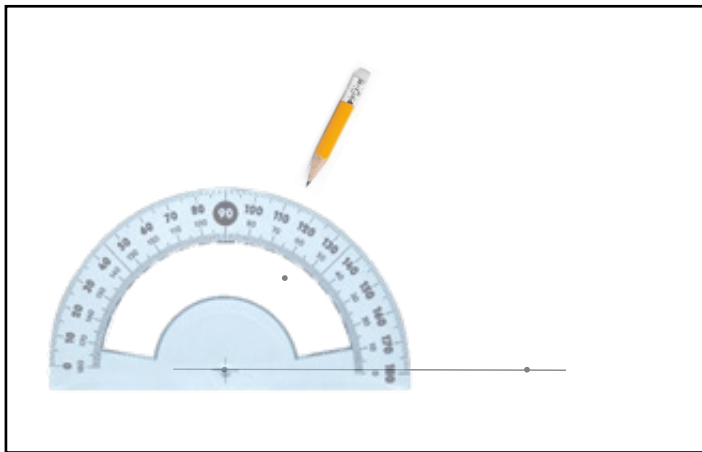

5. Draw a line through the first dot and the dot measuring  $65^\circ$ . Extend the line so that it is at least 8.5 cm long (3.5 cm if using a phone). Do the same step for the other side (second dot on the line).

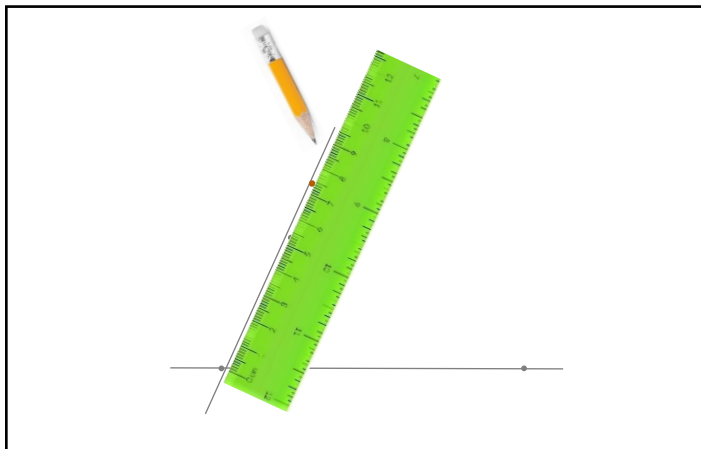

6. Complete the trapezoid by finishing the other side. Draw a line to connect the dots at the top.

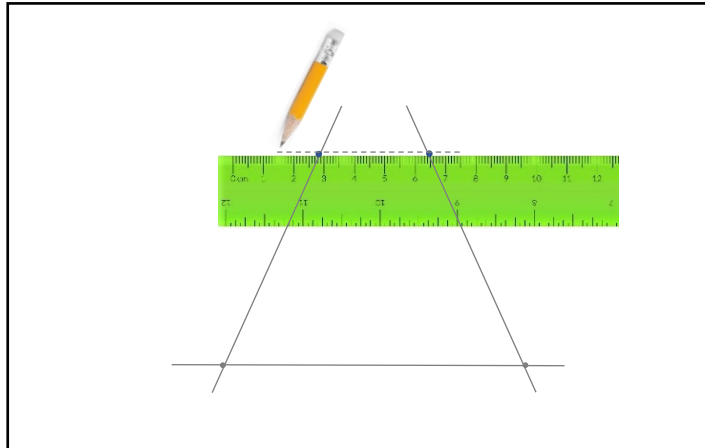

7. Cut out the trapezoid shape and use it as a template to cut four shapes out of the plastic report covers.

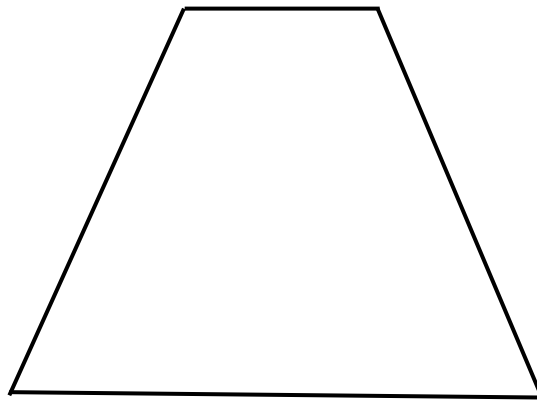

8. Tape or glue (if you used acrylic) the shapes together to create a hologram projector for a cell phone or tablet.

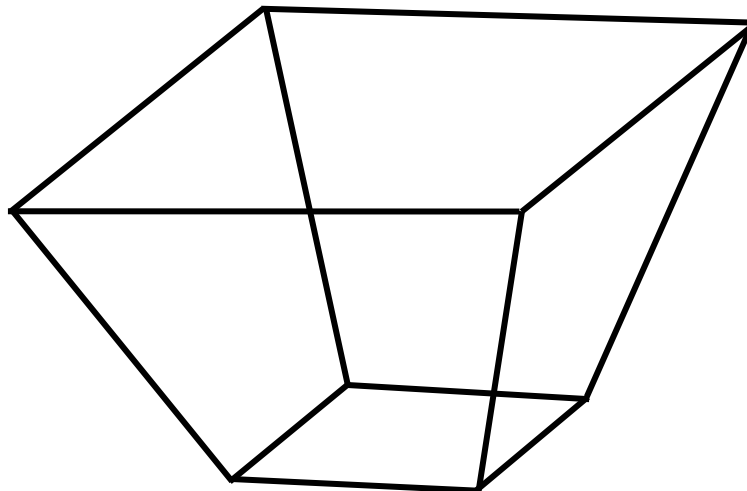

9. Place the projector over a hologram movie on a cell phone or tablet and press play. Watch through the side of the projector.

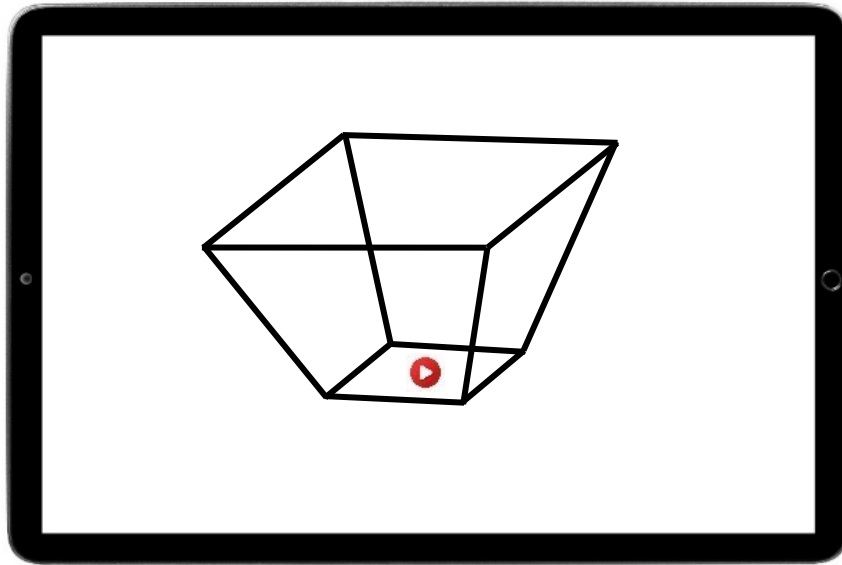

### Observation

1. List observations of how the hologram projector displays the hologram movie you selected. View a regular video using the hologram projector and list observations.

Hologram video observations	Regular video observations