

UNITED STATES  
PATENT AND TRADEMARK OFFICE



# America's Innovative History

Rebekah Oakes

USPTO Historian

March 1, 2024



MEETING SERIES



UNITED STATES  
PATENT AND TRADEMARK OFFICE ®

# What can IP tell us about America's past?

- Incremental progress over time
- What was important to people and why?
- Innovation is all around us
- How can we inspire the next generation of creators?



# Article I, Section 8, Clause 8

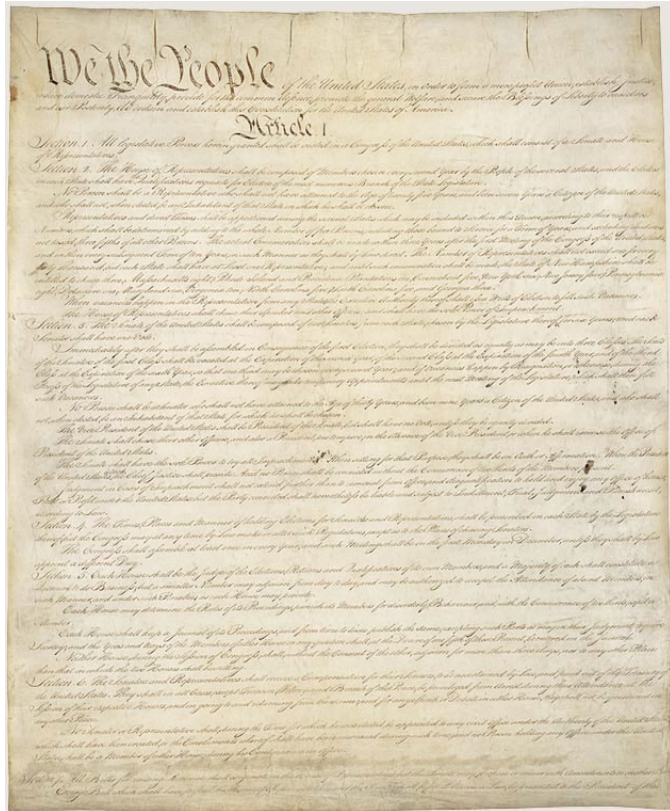

*[The Congress shall have Power . . . ] To promote the Progress of Science and useful Arts, by securing for limited Times to Authors and Inventors the exclusive Right to their respective Writings and Discoveries.*

# Innovation has deep roots



# What did the early IP system look like?

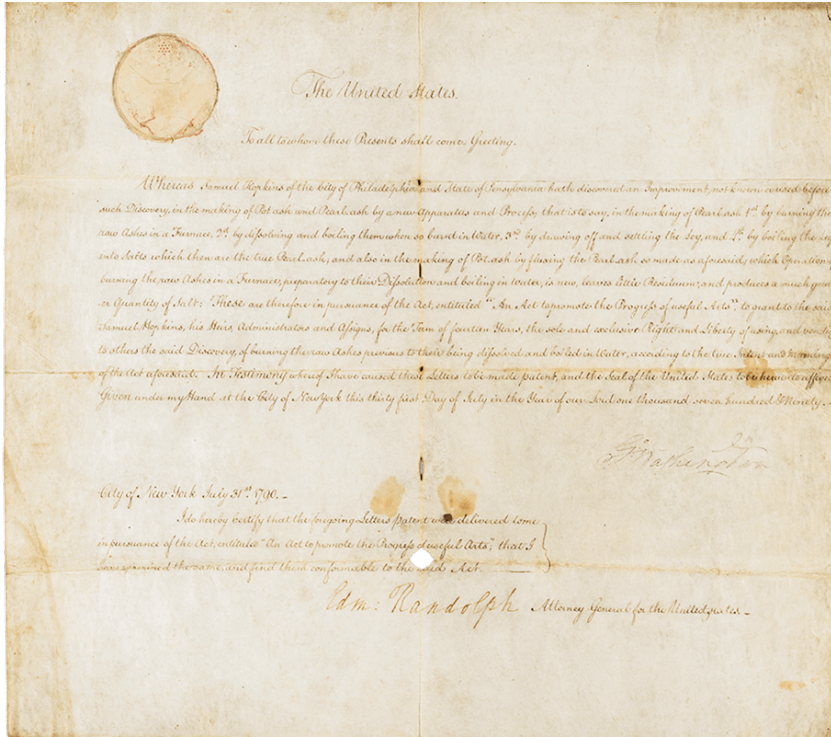

Following passage of the 1790 Patent Act, the first Patent Board, composed of Secretary of State Thomas Jefferson, Secretary of War Henry Knox, and Attorney General Edmund Randolph, begins meeting at regular intervals to examine patents.

# Lots of dedication, not a lot of structure

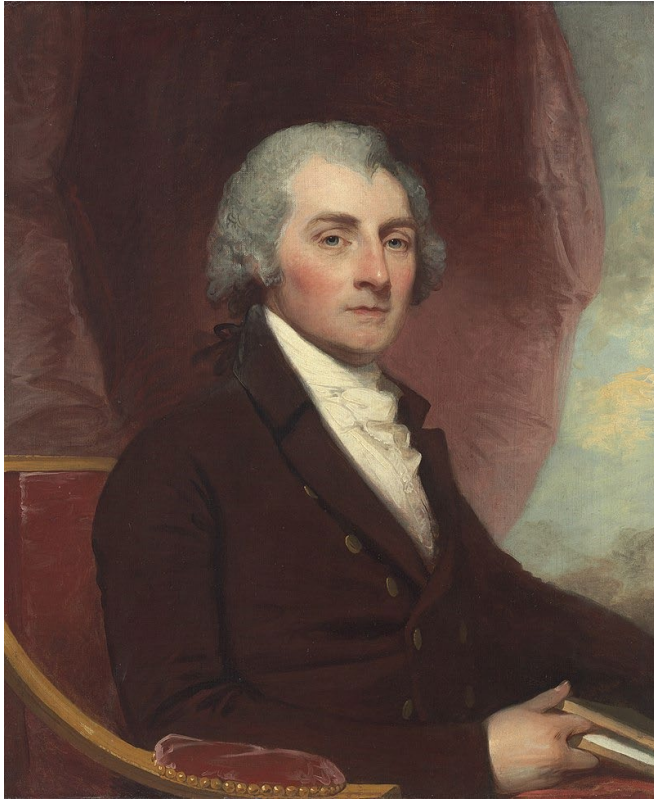

In 1793, Congress did away with the requirement that an invention be "useful and important." Instead, applicants would receive a patent regardless of the invention's merits—regardless of whether the invention or improvement was novel.

# Not X-files, but X-patents

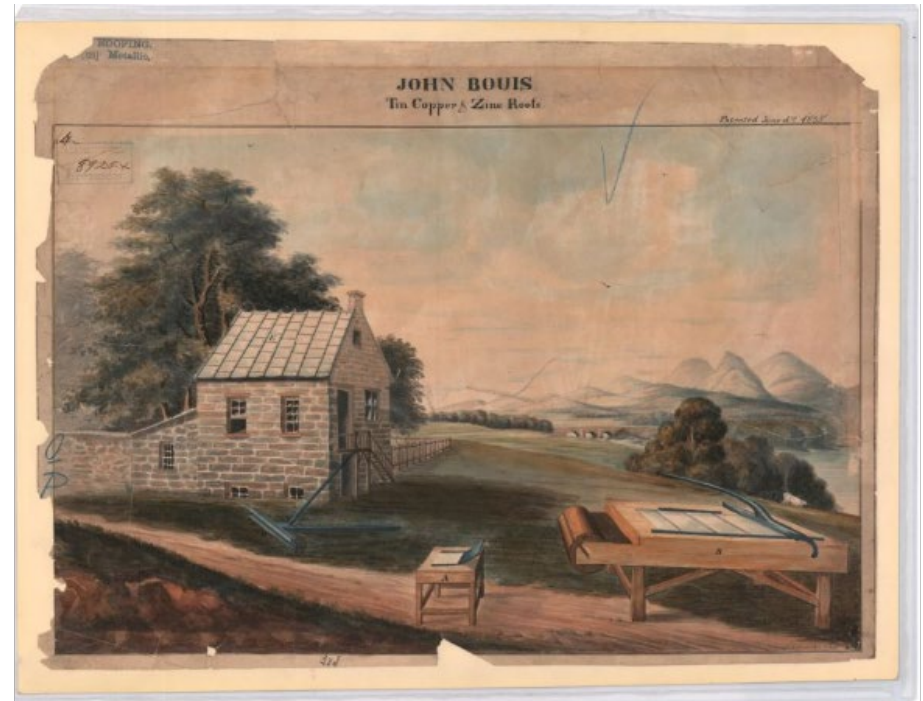



# Patent Act of 1836

- Introduced patent numbering system
- Reintroduced examination requirement and hired professional examiners
- Established a library of prior art

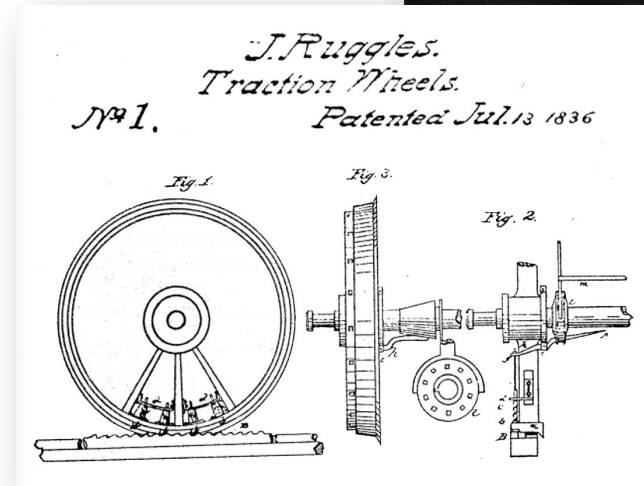
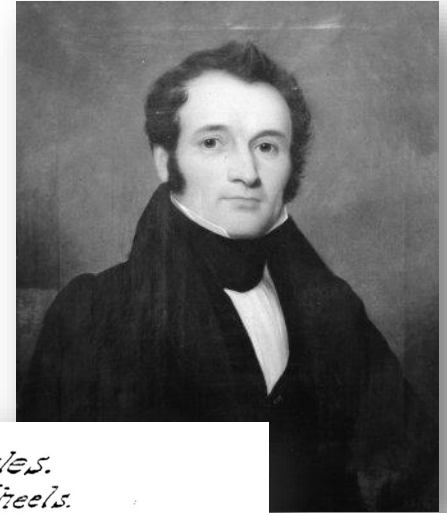

# Patent Office fire of 1836

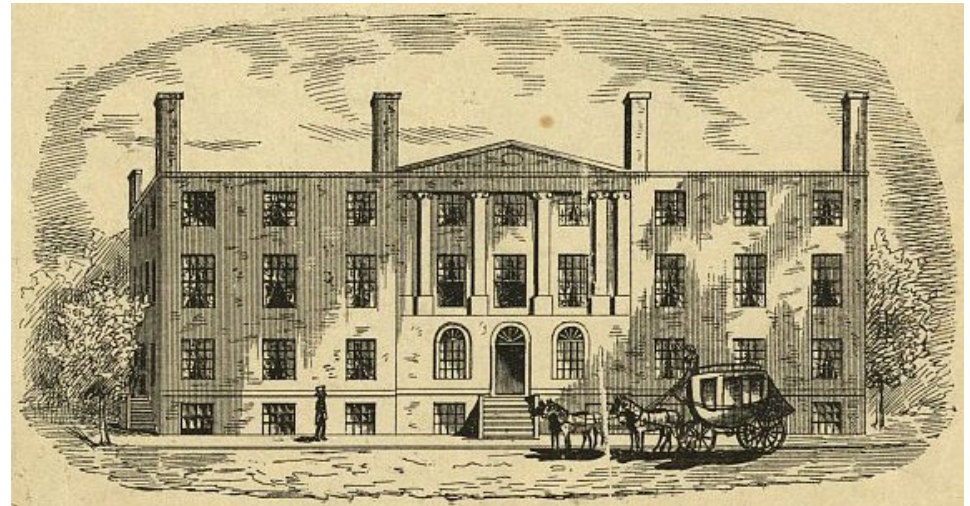

# Patent models

“The Patent Office at Washington, furnishes an extraordinary example of American enterprise and ingenuity; for the immense number of models it contains are the accumulated inventions of only five years; the whole of the previous collection having been destroyed by fire.”

- Charles Dickens, 1842



# A growing office

DESIGN.  
A. BARTHOLDI.  
Statue.  
No. 11,023. Patented Feb. 18, 1879.



Copyright by Barthelemy and Joseph Bartholdi, Aug. 1878.

LIBERTY ENLIGHTENING THE WORLD.

*E. A. Arick  
J. C. Carpenter.*

*Auguste Bartholdi  
by  
A. B. B. B.  
A. B. B.*



uspto®

# Post-war changes and expansion

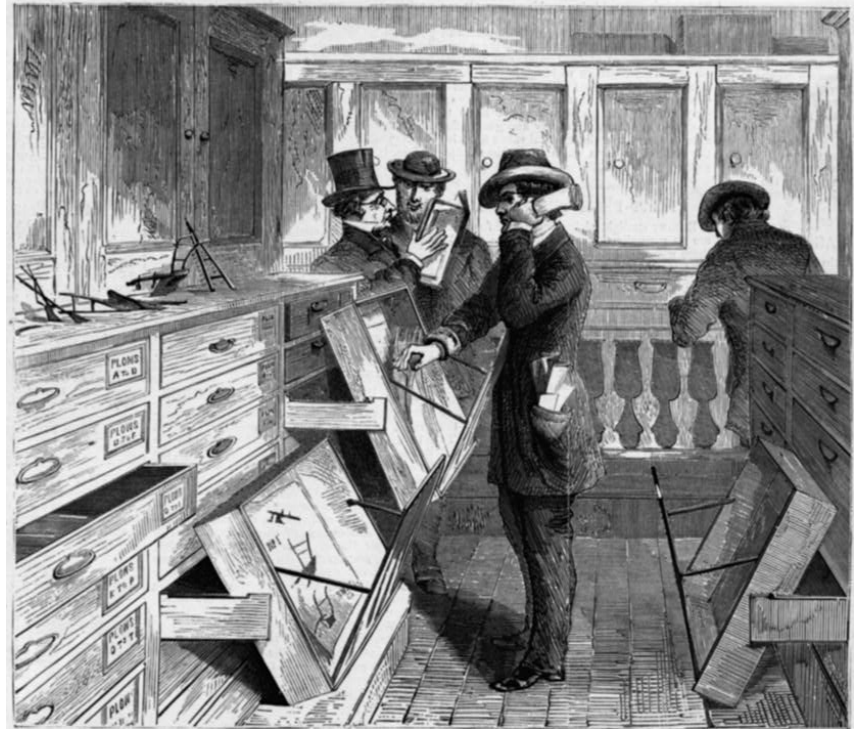

# Trademarks enter the chat



# Golden age of American innovation



Patent fees in the U.S. were uniquely affordable:

| Country | Cost  |
|---------|-------|
| Britain | \$875 |
| Russia  | \$450 |
| Belgium | \$420 |
| Austria | \$350 |
| France  | \$300 |
| USA     | \$35  |

# Innovation as a spectacle

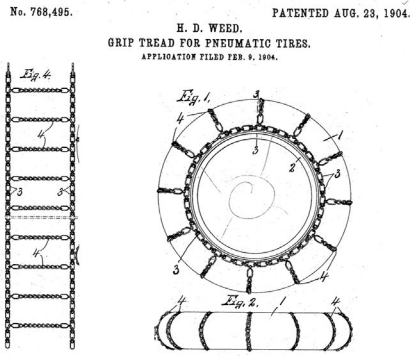

## Weed Anti-skid Chains

*"With the Creeping Grip"*

Would you drive your car with-out brake linings? Certainly you wouldn't. Well driving on wet, greasy pavements and on muddy, slippery roads without Weed Chains is like trying to stop your car with the linings of your brakes removed. **It is impossible to obtain adequate brake control without Weed Chains.**

Don't foolishly pride yourself on taking chances in order to prove your bravery, or to demonstrate your ability as a driver. Take precaution now. Consider your own safety—consider the safety of other road users.

Weed Chains are an **absolute necessity** on both rear tires and to doubly guard yourself against accidents, and to make steering comfortable and easy, put them on the **front tires too**. Cannot injure tires because "they creep." Occupy very little space when not in use. Applied in a moment without the use of a jack.

Equip your car today with Weed Chains and **insist** for your own protection that others do the same.

Recommended and sold by all reputable dealers

**Weed Chain Tire Grip Company**  
 28 Moore Street . . . . . New York

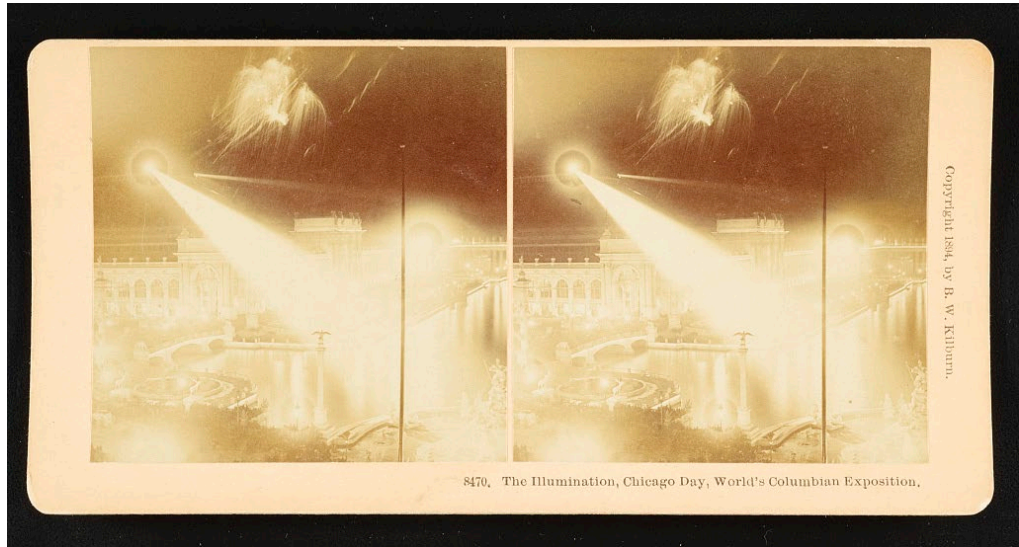

8470, The Illumination, Chicago Day, World's Columbian Exposition.





# Innovation and equality

List of Colored Inventors  
in the United States as furnished for  
The Paris Exposition, 1900.

| Name             | Invention  | Date        | Number    |
|------------------|--|-------------|-----------|
| Abney, H. B.     | Auto Attachment  | Apr. 14/91  | 1154, 550 |
| Allen, W.        | Self-Leveling Gullies                                  | Nov. 1/98   | 613, 438  |
| Allen, J. B.     | Clothesline for<br>porch                               | Dec. 20/98  | 551, 105  |
| Ashbourne, A. T. | Process for preparing<br>ing cream for<br>domestic use | June 1/95   | 183, 962  |
| Ashbourne, P.    | Biscuit Cutter   | Nov. 30/90  | 170, 460  |
| Ashbourne, P.    | Refining Coconut<br>Oil                                | July 1/90   | 200, 578  |
| Bailey, L. C.    | Combined Trench<br>and Partridge<br>Folding Bed        | Sept. 25/93 | 255, 575  |
| Bailey, L. C.    | Folding Bed  | July 8/99   | 629, 286  |
| Bailey, Wm.      | Saddle Seat<br>fold up for<br>shampier                 | Aug. 5/99   | 218, 154  |
| Bailiff, C. O.   | Head-Rect  | Oct. 11/98  | 612, 078  |
| Ballou, H. J.    | Combined Hat<br>Rack and Table                         | Mar. 29/91  | 601, 422  |
| Barnes, Wm.      | Design for signaling                                   | Apr. 6/99   | 629, 193  |
| Beard, G. J.     | Rotary Engine  | July 15/92  | 498, 271  |
| Beard, G. J.     | Car Coupler  | Nov. 23/99  | 594, 059  |
| Beech, H. E.     | Letter Box   | Oct. 11/92  | 483, 625  |



# Innovation and equality

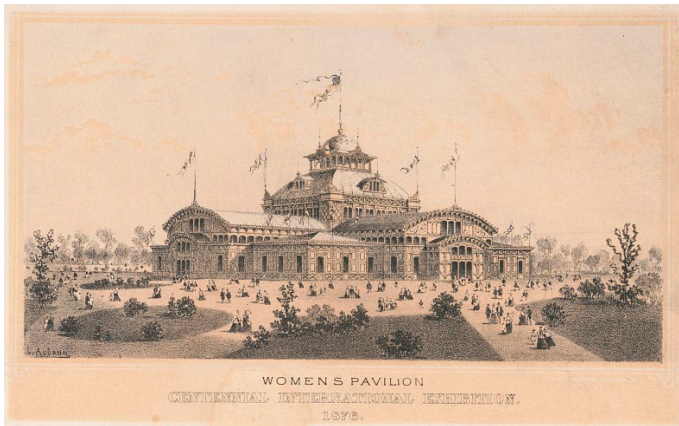

# Plant patents



United States Patent [19]  
Mikkelsen

[11] Plant 4,000  
[45] Dec. 28, 1976



uspto

uspto®

# Lanham Act and consumerism

Jan. 28, 1947.

R. T. JAMES  
TOY AND PROCESS OF USE  
Filed Aug. 21, 1946

2,415,012

3 Sheets-Sheet 2

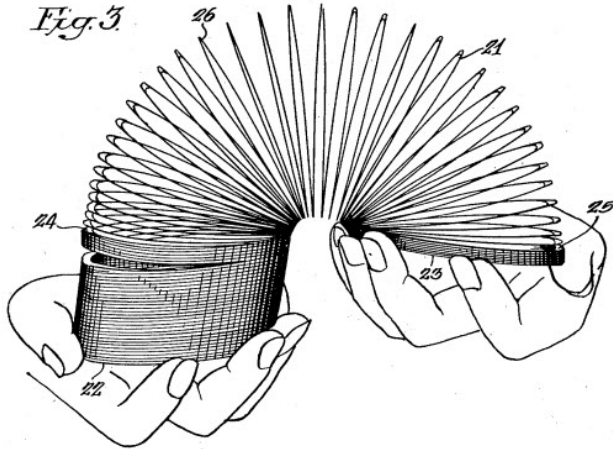

Int. Cl.: 28

Prior U.S. Cl.: 22

United States Patent and Trademark Office

Reg. No. 1,455,493  
Registered Sep. 1, 1987

TRADEMARK  
PRINCIPAL REGISTER

SLINKY

JAMES INDUSTRIES, INC. (PENNSYLVANIA  
CORPORATION)  
BEAVER STREET EXTENSION  
HOLLIDAYSBURG, PA 16648  
FOR: TOYS OF METAL AND PLASTIC.

BUILDING BLOCKS AND PIECES, IN CLASS  
28 (U.S. CL. 22).  
FIRST USE 0-0-1945; IN COMMERCE  
0-0-1945.  
OWNER OF U.S. REG. NOS. 427,951, 1,276,398  
AND OTHERS.



uspto®

# New technologies and tech transfer

Dec. 21, 1965

T. O. EDDINS

3,224,336

MISSILE LAUNCH RELEASE SYSTEM

Filed May 25, 1964

2 Sheets-Sheet 1

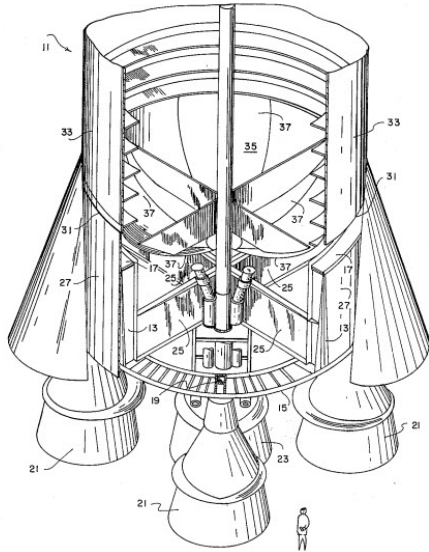
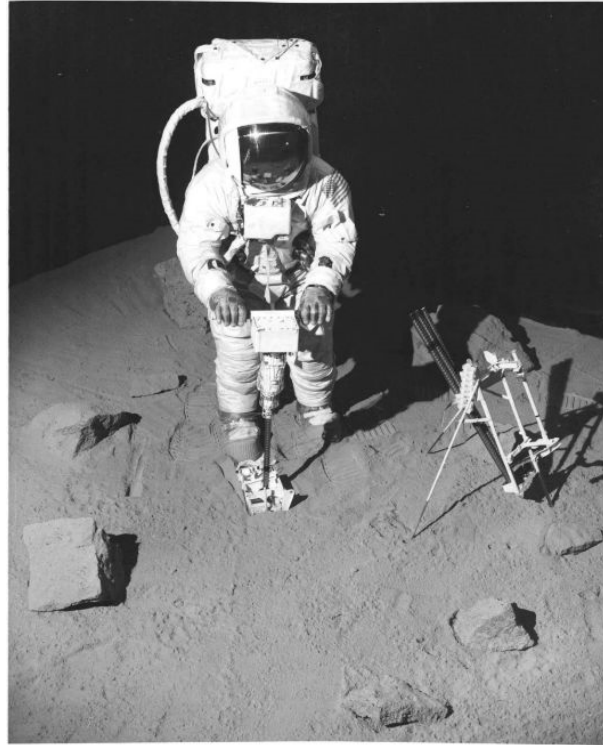

FIG. 1



U.S. Patent Sep. 30, 1980

Sheet 1 of 2

4,225,814

FIG 1

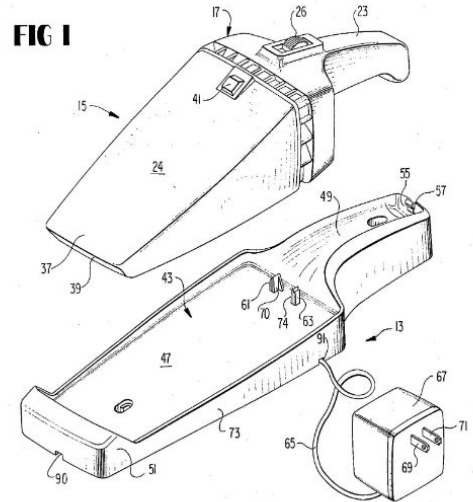

uspto®

# Rapid increase and expansion

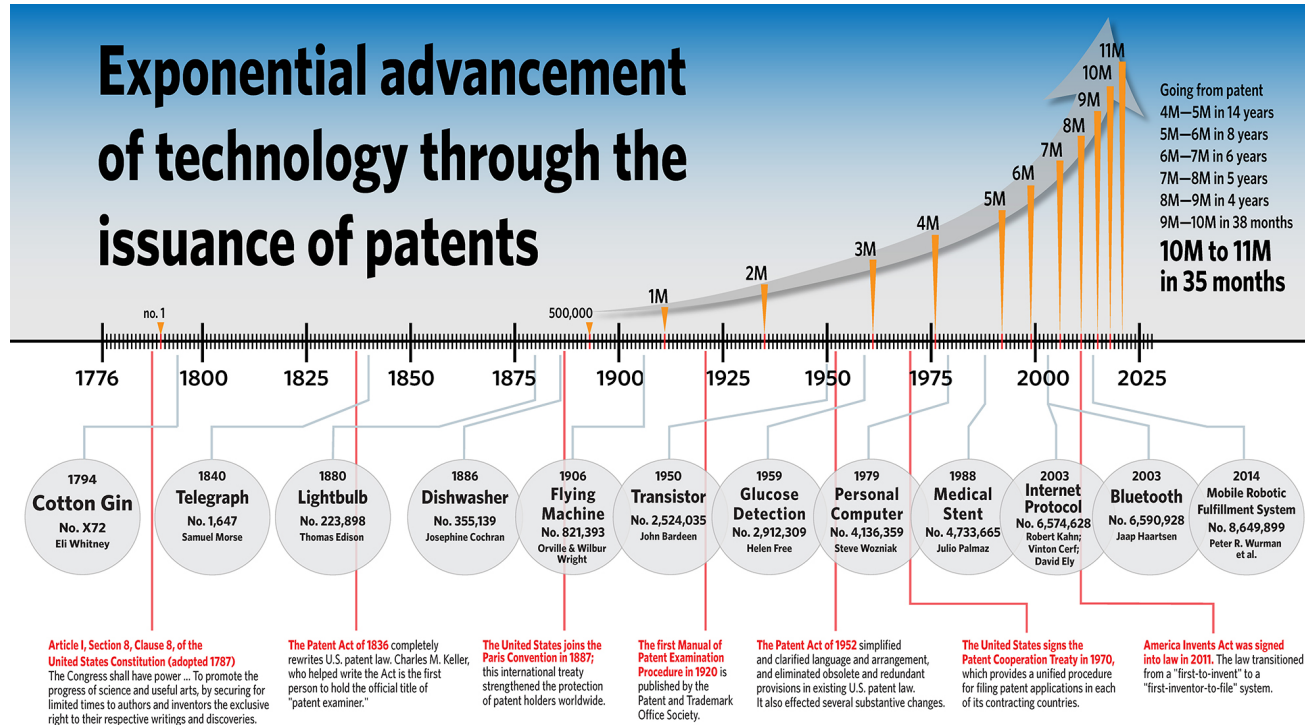

# America Invents Act - 2011

- Regional offices
- Patent Pro Bono services in all 50 states
- First inventor to file
- More patent examiners

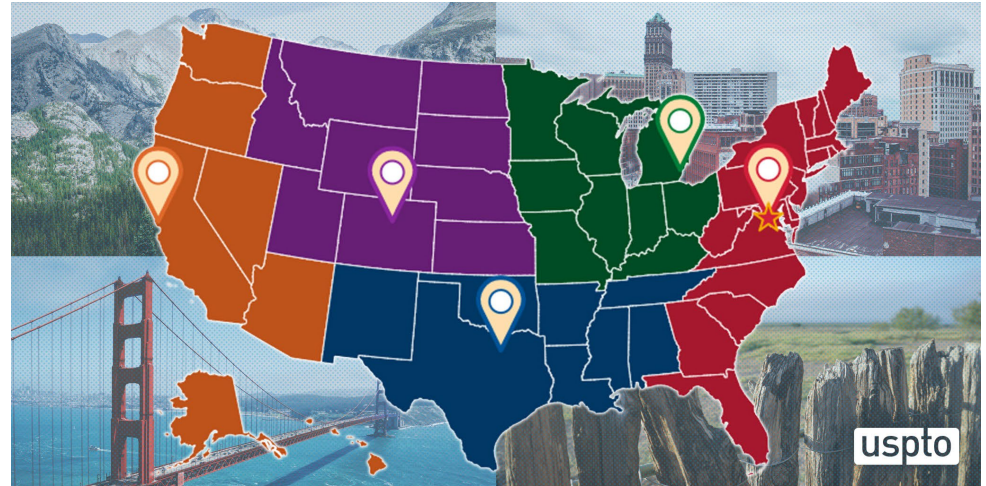

# What questions do we grapple with today?



AI and  
Emerging  
Technologies  
Partnership

International  
perspectives:

Intellectual Property, small  
and medium-sized enterprises,  
and global markets



uspto®



# Want more history?

- Learn more at [www.uspto.gov/about-us/history](http://www.uspto.gov/about-us/history)
- Check out our Journeys of Innovation series
- Follow us on social media!

## Learn from the innovators of the past

### Browse Journeys of Innovation articles featuring innovators throughout history

The USPTO seeks to inspire and encourage diversity and innovation by highlighting innovators throughout history and chronicling their stories. Find inspiration from the [Journeys of these inventors and entrepreneurs](#) – where they got their start, the challenges they faced, and what it took to bring their ideas to fruition and their brands that impact society to life. These stories also emphasize the importance of creating and protecting intellectual property, and the critical role it has played in innovations past and present.

Browse all stories below, or search for a name or story title.

### Story archive

Search for a name, company, or story title

**A district of determination >**  
James Wormley, Miriam Benjamin, and Robert Pelham

**Of courage and caution >**  
Garrett Morgan

**A girl's window into history >**  
Pleasant Rowland

**Found on Baker's list >**  
Henry Baker and George Washington Murray



