

A41C

CORSETS; BRASSIERES

Definition statement

This place covers:

Corsets or girdles being a special type of undergarments for shaping or correction of a figure, with or without stays or steels, auxiliary belts, straps or fasteners; corsets with or without brassieres, e.g. of annular or tubular shape; girdles, e.g. with high waist part, with open bottom, or girdles of panty type, e.g. with elongated thigh part with or without suspenders.

Brassieres being a type of undergarments for supporting or shaping breasts having connected or separate cups including strapless, backless brassieres, e.g. self-adhesive bra cups, or brassieres with stiffening or bust-forming inserts, e.g. with pads containing gel or foam filling, with pockets; bra specially adapted for nursing mothers, e.g. fold-down convertible bra or with replaceable absorbing pads or cups; bra cups with massage elements.

Details of corsets, girdles or brassieres relating to materials used in making process thereof, e.g. elastic corsets including corsets made of rubber, or of layered materials; special materials for nursing mother brassieres or brassieres for sport activities.

Machines or appliances for manufacturing corsets or brassieres, such as integrated manufacturing system or production lines including, e.g. cutting or sewing machines, ironing-machines, attachment mechanisms for assembling component parts, circular knitting machines, machines for molding cup-shaped parts.

Methods for manufacturing corsets or brassieres, mostly the combination of individual process steps such as mechanical treatment e. g. pattern cutting or sewing, physical treatment with the use of high temperature or pressure e.g. hot pressing forming die for a brassiere cup, thermoforming for shape retention or hardening of the articles, high temperature adhering and pressing process without sewing, ultrasonic adhering, antibacterial treatment, aromatizing or steeping by perfume, chemical methods for densification of the knitted stitches; methods of manufacturing one piece bra; finishing edges.

Relationships with other classification places

Group [A41B 17/00](#) "Selection of special materials for underwear" is used not only with groups [A41B 9/00](#) "Undergarments" or [A41B 13/00](#) "Baby linen" but it should also be used together with groups [A41C 1/00](#) and [A41C 3/00](#) if the material of articles is of interest.

Manufacturing of corsets, girdles or bras is classified in group [A41C 5/00](#). However provided that a subject of the invention concerns also an individual step of the combined method or an individual machine of the aggregated plant such information can be separately classified in the appropriate places of the CPC in sections B or D, e.g. in groups:

[B32B 37/00](#) Methods or apparatus for laminating, e.g. by curing or by ultrasonic bonding;

[B29C 51/00](#) Shaping by thermoforming, e.g. shaping sheets in matched moulds or by deep-drawing; Apparatus therefor;

[D04B 1/24](#) Weft knitting processes for the production of fabrics or articles not dependent on the use of particular machines; Fabrics or articles defined by such processes specially adapted for wearing apparel;

[D04B 21/14](#) Fabrics characterised by the incorporation by knitting, in one or more thread, fleece, or fabric layers, of reinforcing, binding, or decorative threads; Fabrics incorporating small auxiliary elements, e.g. for decorative purposes;

[D06C 29/00](#) Finishing or dressing, of textile fabrics;

Relationships with other classification places

[D06M 23/14](#) Processes for the fixation or treatment of textile materials in three-dimensional forms

[D05C 7/00](#) Special-purpose or automatic embroidering machines

References

Application-oriented references

Examples of places where the subject matter of this place is covered when specially adapted, used for a particular purpose, or incorporated in a larger system:

Non-implantable mammary prostheses	A61F 2/52
Orthopaedic corsets	A61F 5/02
Nursing devices in the form of corsets or bandages for abdomen, teat, or breast support, with or without pads	A61F 5/03
Bandages specially adapted for breast or abdomen	A61F 13/14
Absorbent pads for external application to the body	A61F 13/15

Informative references

Attention is drawn to the following places, which may be of interest for search:

Combined undergarment	A41B 9/08
Waistbands forming part of the undergarments	A41B 9/14
Shoulder-straps forming part of undergarments	A41B 9/16
Maternity clothing	A41D 1/21
Clothing specially adapted for women	A41D 1/22
Swim-suits, beach suits	A41D 7/00
Corset fasteners	A41F 1/04
Shoulder or like straps in general	A41F 15/00

Glossary of terms

In this place, the following terms or expressions are used with the meaning indicated:

Corset	(n) tight-fitting undergarments often reinforced by stays, worn to support and shape the waistline, hips, and breasts.
Girdle	(n) a woman's corset extending from waist to thigh
Stay	(n) a flat strip of steel, plastic, etc., used especially for stiffening corsets, collars, etc. (in.pl.) hist. a corset esp. with whalebone etc. stiffening, and laced
Steel	(n) a steel stiffener in a corset, etc.

Synonyms and Keywords

In patent documents, the following abbreviations are often used:

Bra	Brassiere
-----	-----------

In patent documents, the following words/expressions are often used as synonyms:

- Girdle, Stays, Corset

In patent documents, the word/expression in the first column is often used instead of the word/expression in the second column, which is used in the classification scheme of this place:

Foundation garment	Bra
--------------------	-----

A41C 1/00

Corsets or girdles

Definition statement

This place covers:

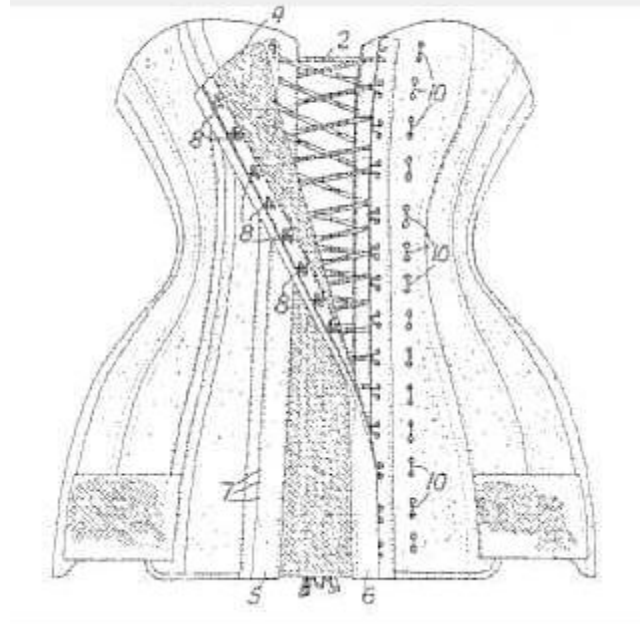
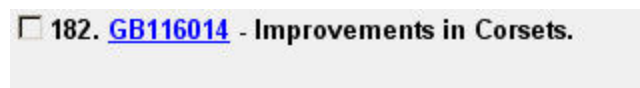
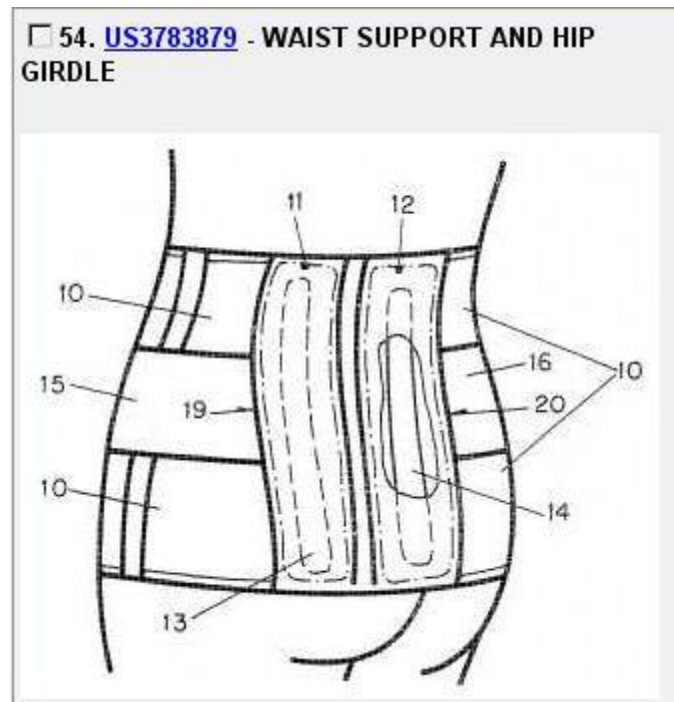

References

Application-oriented references

Examples of places where the subject matter of this place is covered when specially adapted, used for a particular purpose, or incorporated in a larger system:

Orthopaedic corsets	A61F 5/02
---------------------	---------------------------

Informative references

Attention is drawn to the following places, which may be of interest for search:

Corsets fasteners	A41F 1/04
-------------------	---------------------------

Special rules of classification

When girdle is used to shape body, class in [A41C 1/00](#) and lower groups.

When girdle is used to support trouser or skirt, class in [A41F 9/00](#) and lower groups.

If girdle is further used to support stocking or socks, classify also as additional information in [A41F 11/00](#).

A41C 1/003

{Panty-girdles}

Definition statement

This place covers:

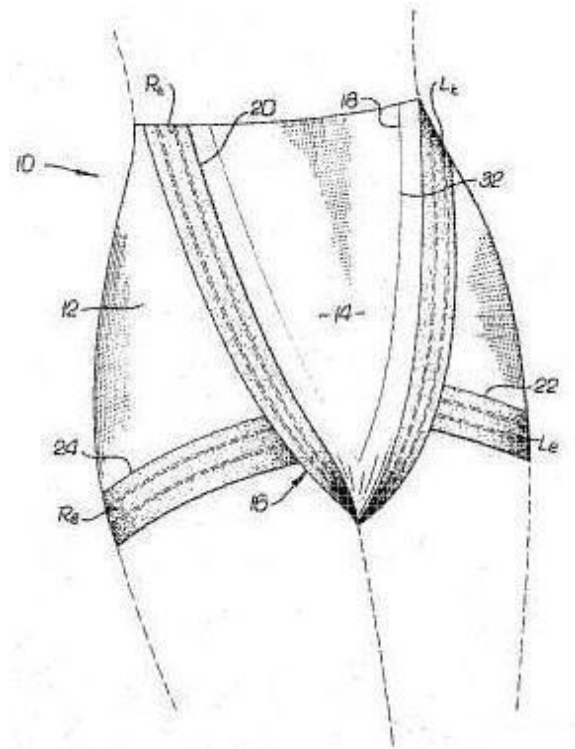

□ 9. [WO2007087545](#) - (A2 A3) BODY-SHAPING APPAREL

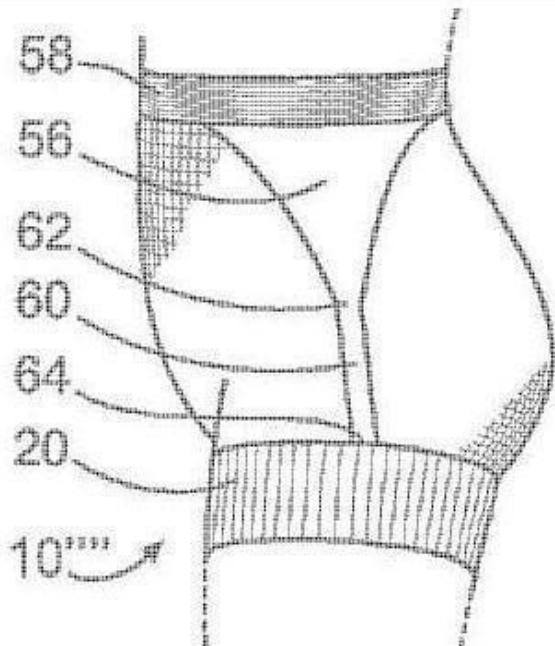

A41C 1/006

{Corsets or girdles provided with means preventing the riding-up of the garment}

Definition statement

This place covers:

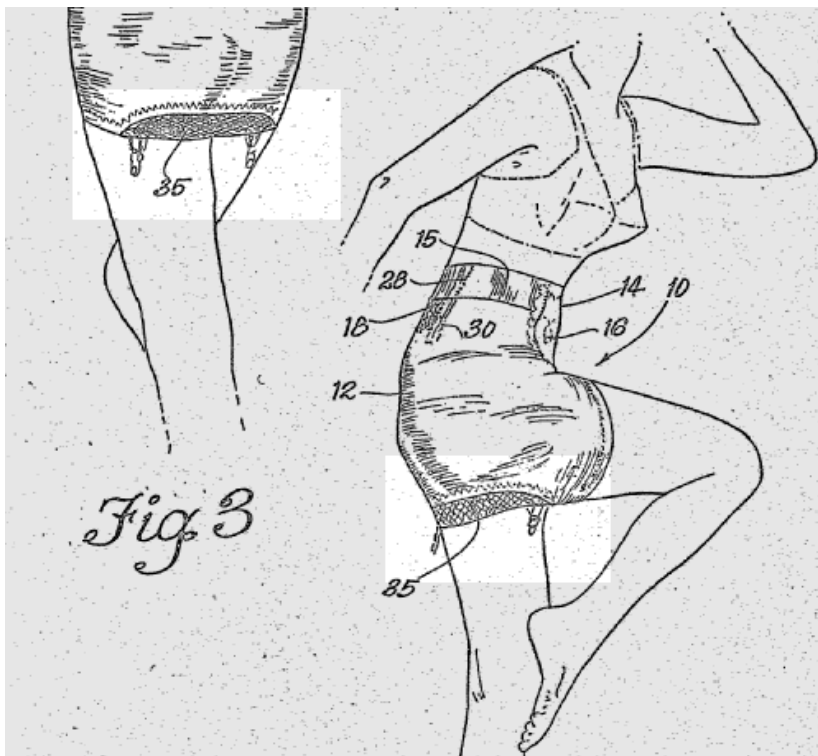

A41C 1/02

Elastic corsets

Definition statement

This place covers:

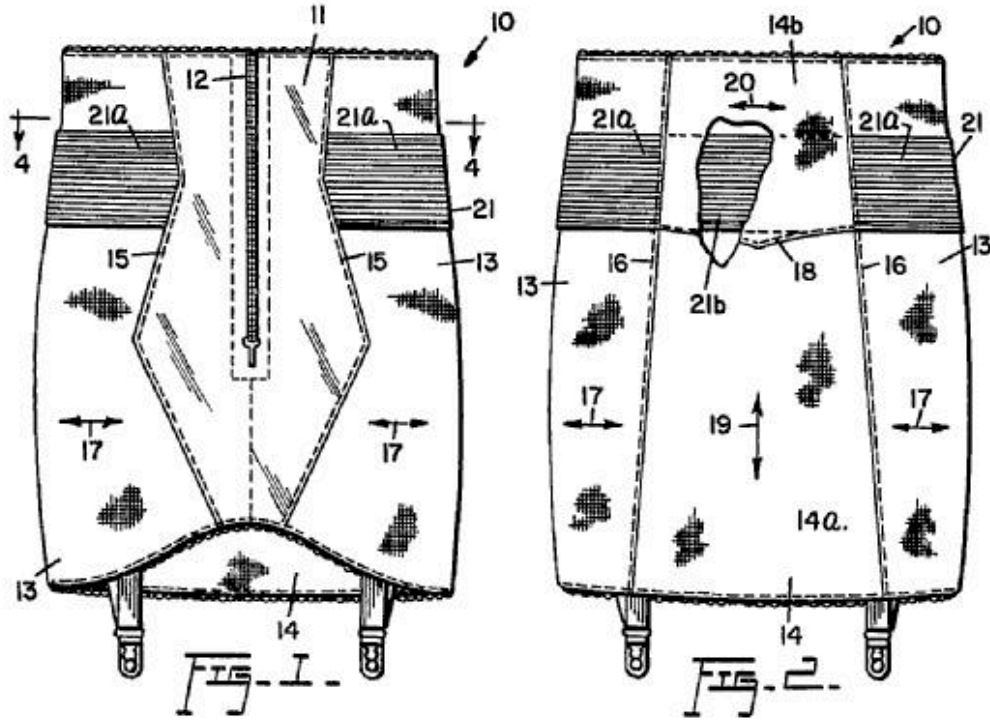

A41C 1/06

with brassieres

Definition statement

This place covers:

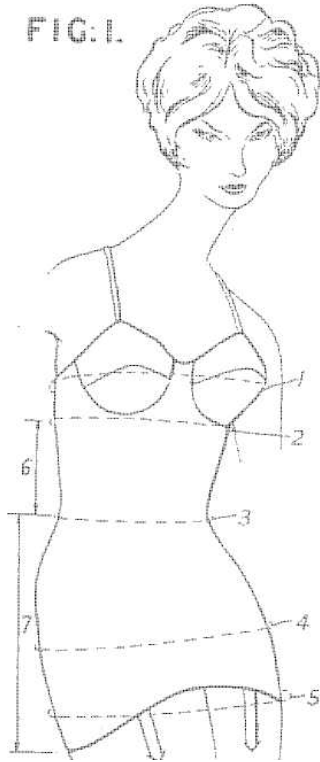

A41C 1/08

Abdominal supports

Definition statement

This place covers:

□ 38. [US5752873](#) - Abdominal support and slimming garment

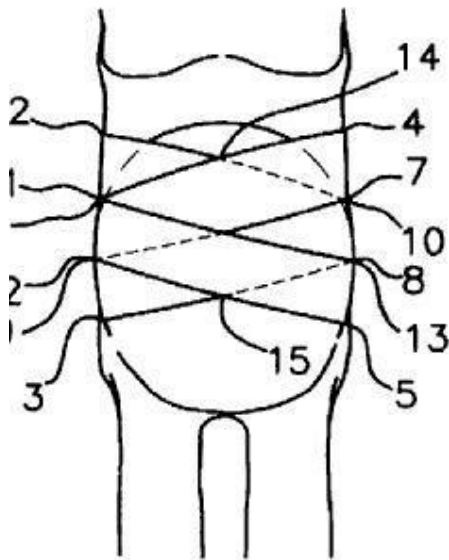
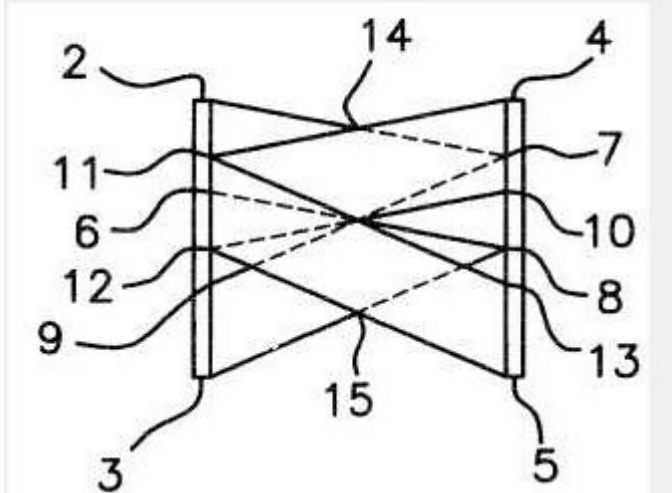

FIG. 3

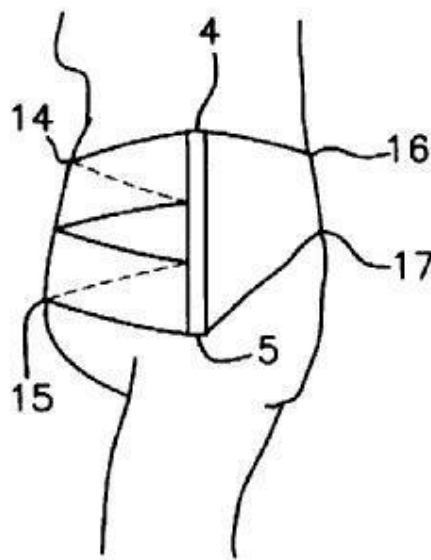

FIG. 4

References

Informative references

Attention is drawn to the following places, which may be of interest for search:

Orthopaedic corsets	A61F 5/02
---------------------	---------------------------

A41C 1/10

Maternity corsets

Definition statement

This place covers:

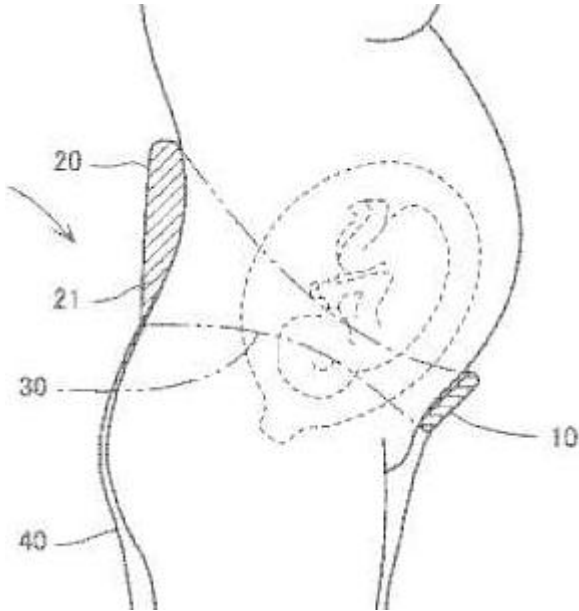

□ 32. [WO9841117](#) - POST-PREGNANCY COMPRESSION GARMENT

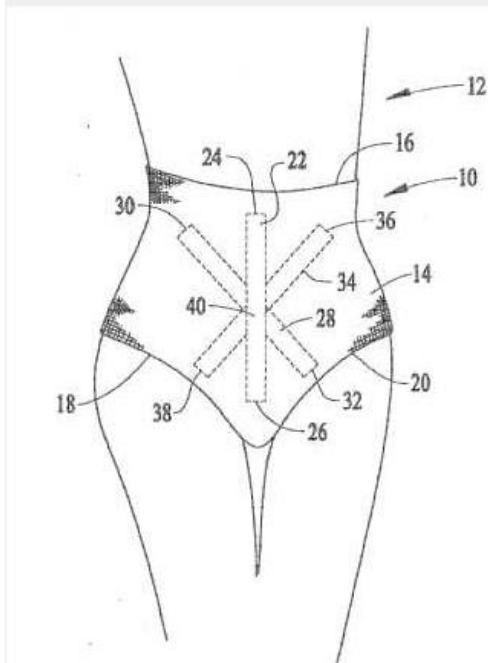

References

Informative references

Attention is drawn to the following places, which may be of interest for search:

Maternity clothing	A41D 1/21
--------------------	---------------------------

Orthopaedic corsets

[A61F 5/02](#)

Special rules of classification

Comprises also post-pregnancy supports.

A41C 1/12

Component parts

Definition statement

This place covers:

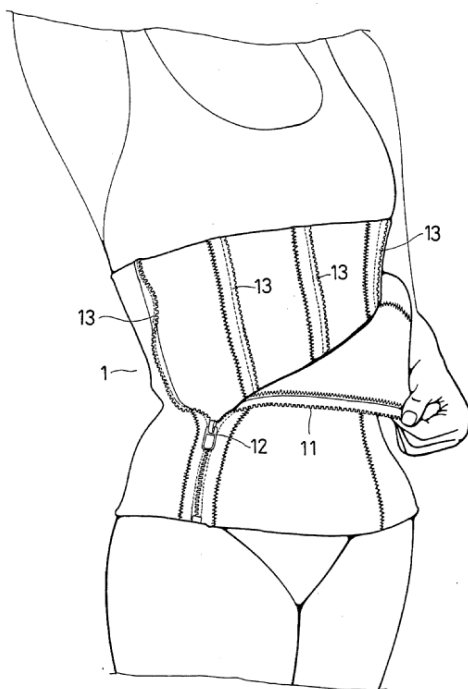

FIG. 1

A41C 1/14

Stays; Steels

Definition statement

This place covers:

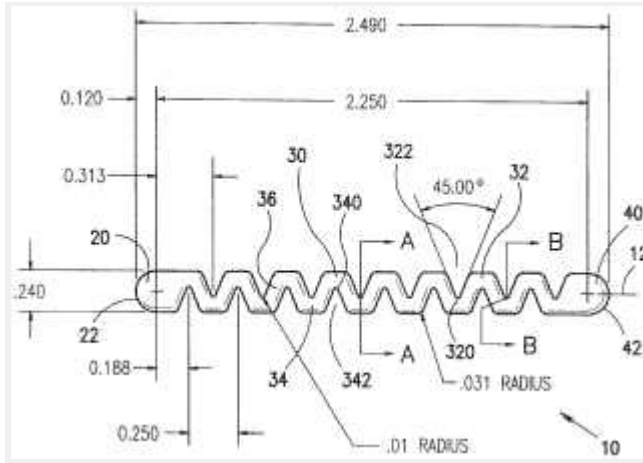

A41C 1/16

made of wire

Definition statement

This place covers:

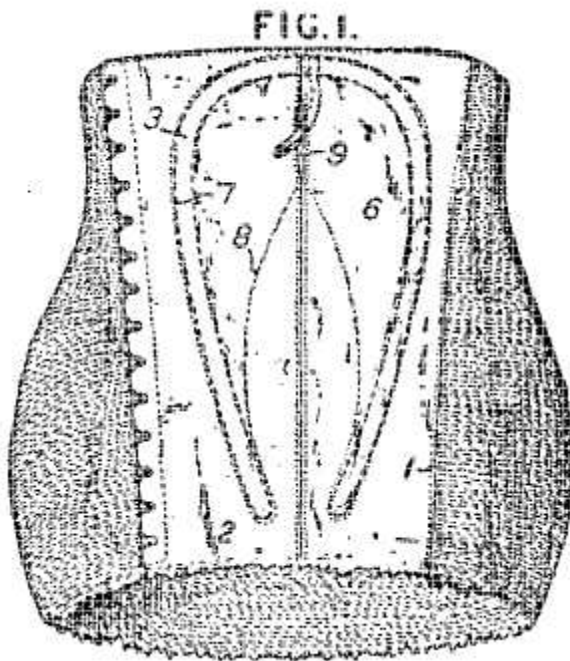

A41C 1/18

of built-up type

Definition statement

This place covers:

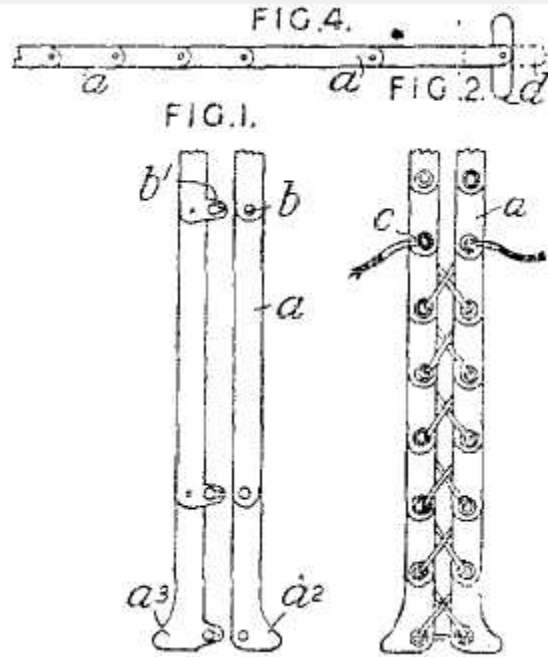
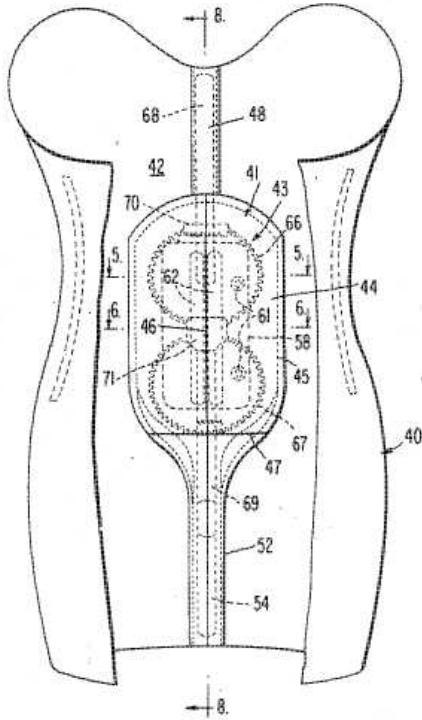

A41C 1/20

with protective caps

Definition statement

This place covers:

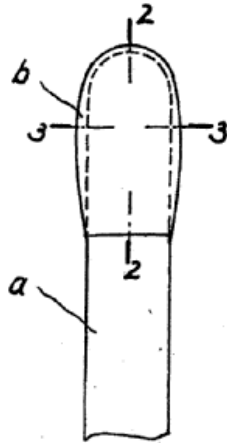

Fig. 1



Fig. 2



Fig. 3

A41C 3/0014

{made from one piece with one or several layers}

Definition statement

This place covers:

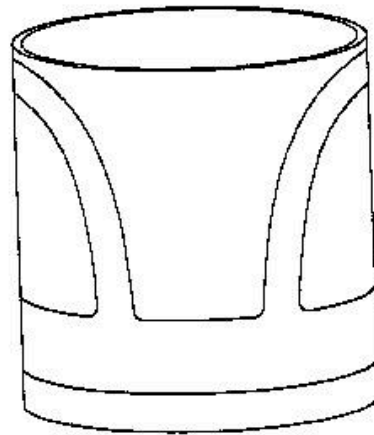
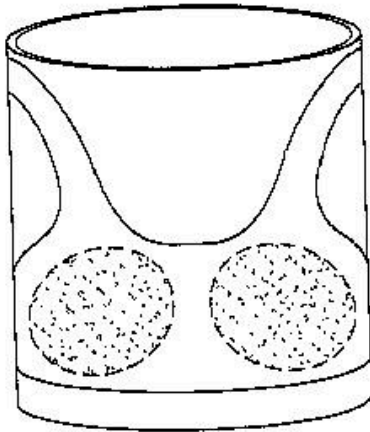
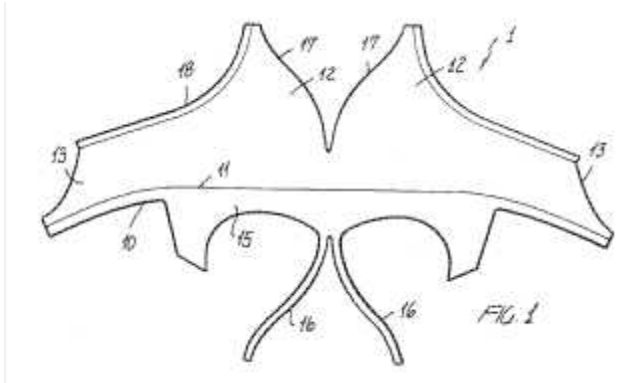

A41C 3/0021

{with suspension construction for the breasts}

Definition statement

This place covers:

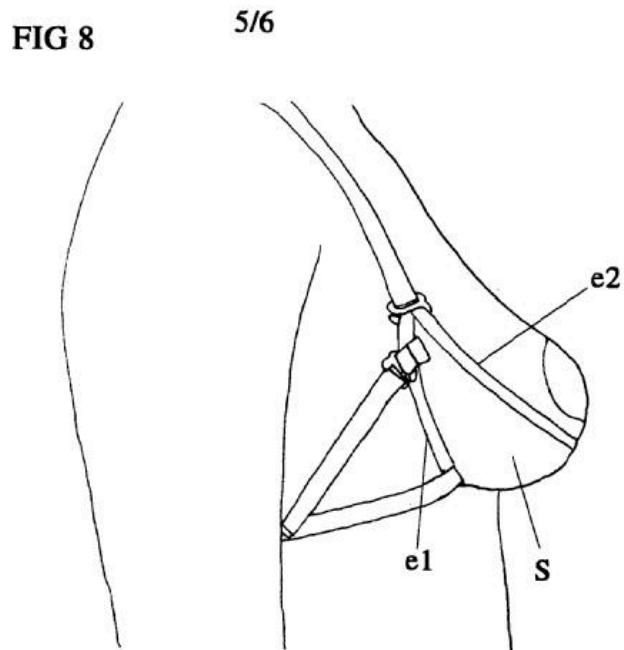

□ 24. [WO2010062164](#) - BRASSIERE WITH IMPROVED BREAST-LIFTING SYSTEM

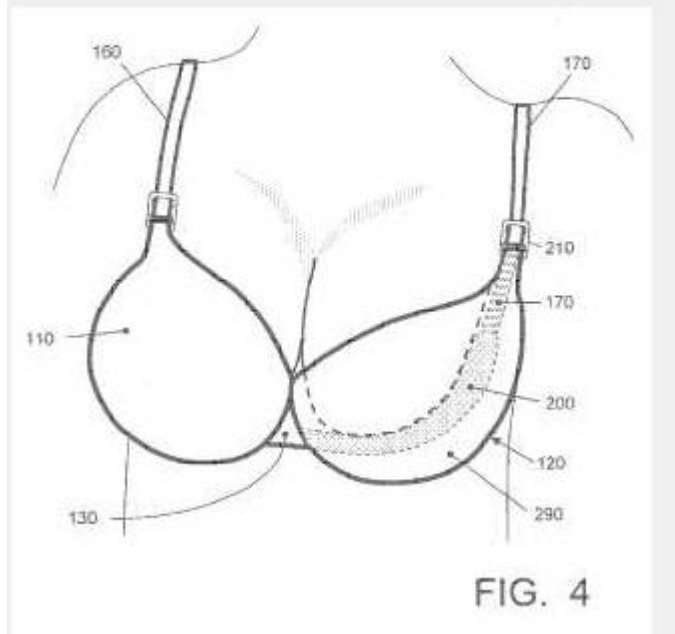

A41C 3/0028

{with size and configuration adjustment means}

Definition statement

This place covers:

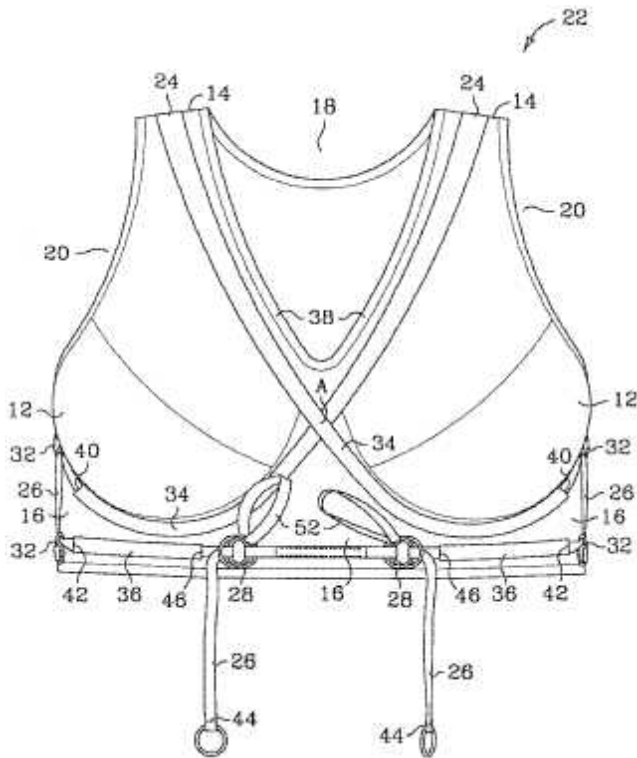
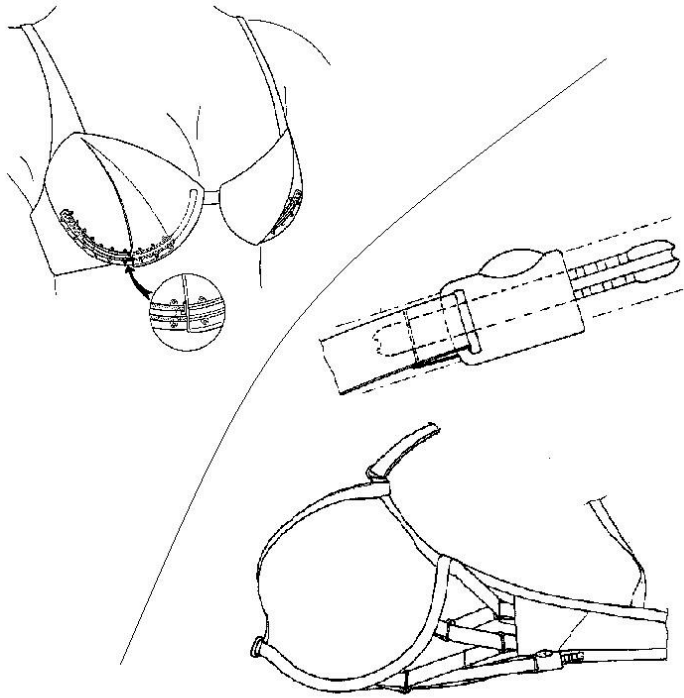

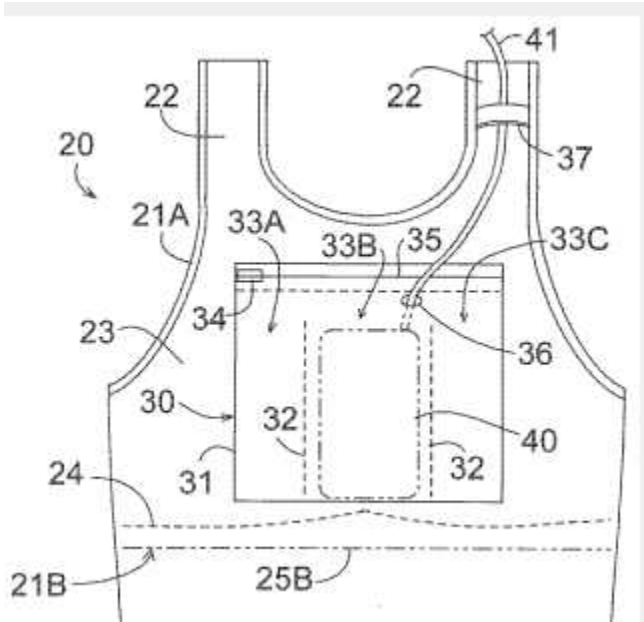
A41C 3/0035**{with pockets}****Definition statement***This place covers:***References*****Informative references****Attention is drawn to the following places, which may be of interest for search:*

Medicine delivery patches	A61K 9/7023
---------------------------	-----------------------------

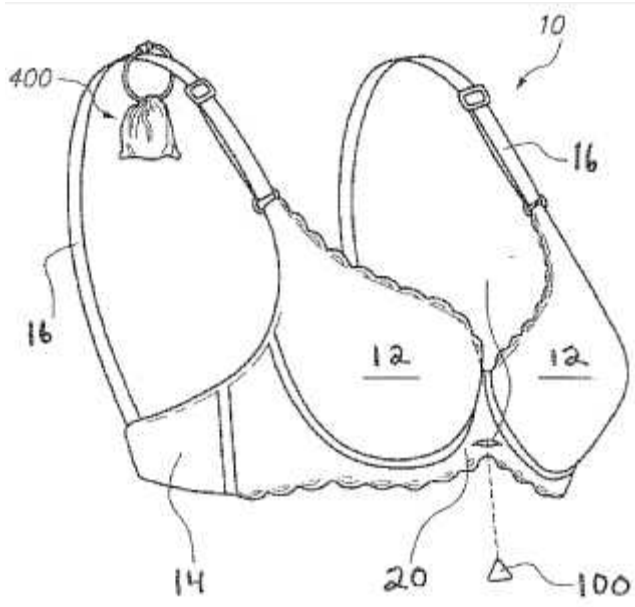
A41C 3/0042**{diffusing perfume or the like}****Definition statement***This place covers:***References****Informative references***Attention is drawn to the following places, which may be of interest for search:*

Containers for holding perfume	A45D 34/00
Holders for air deodorants	A61L 9/12
Body deodorants	A61Q 15/00
Perfumes encapsulated in a carrier	C11D 3/505
Perfumes released by thermal or chemical activation	C11D 3/507
Textiles containing perfume or deodorants	D06M 13/005

A41C 3/005

{specially adapted for specific purposes (prosthetic brassieres [A41C 3/148](#))}

Definition statement

This place covers:

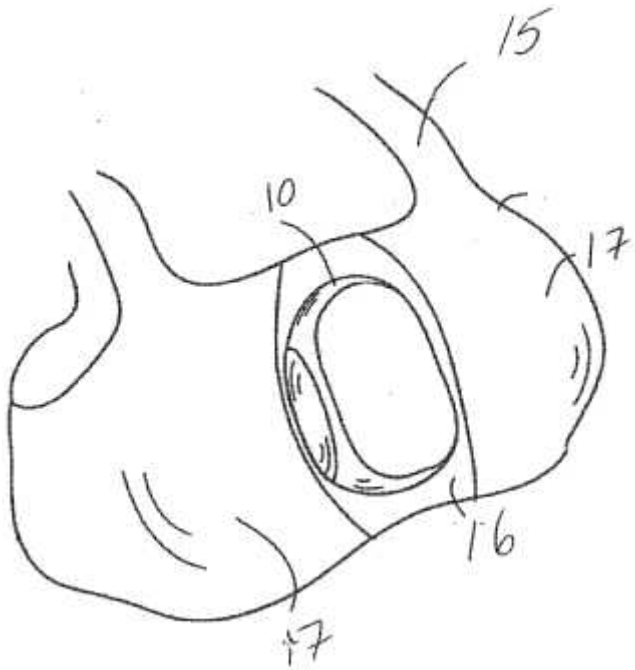

A41C 3/0057

{for sport activities}

Definition statement

This place covers:

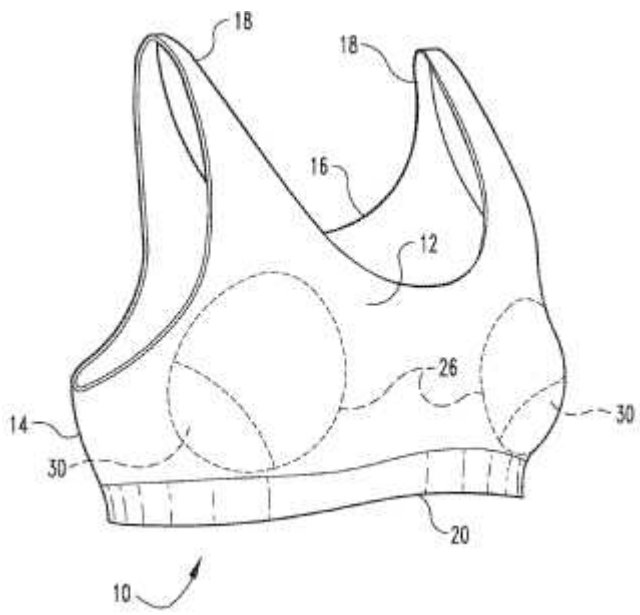

A41C 3/0064

{for medical use or surgery}

Definition statement

This place covers:

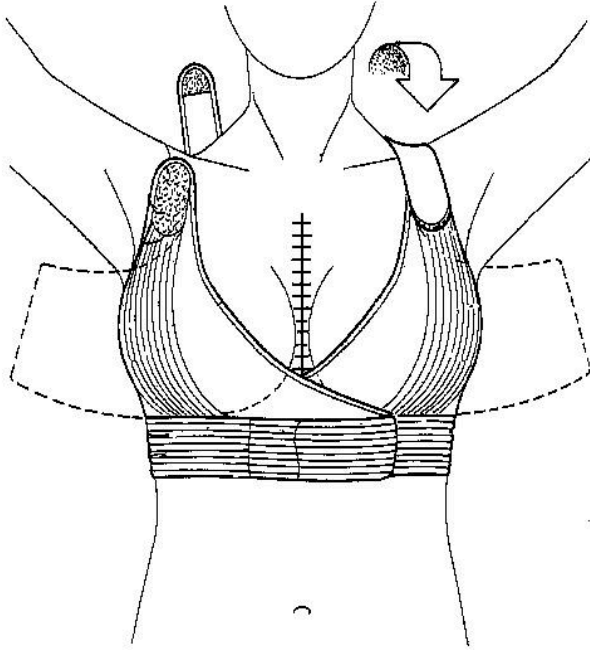

References

Informative references

Attention is drawn to the following places, which may be of interest for search:

Prosthetic brassieres	A41C 3/148
-----------------------	----------------------------

A41C 3/02

with front closures

Definition statement

This place covers:

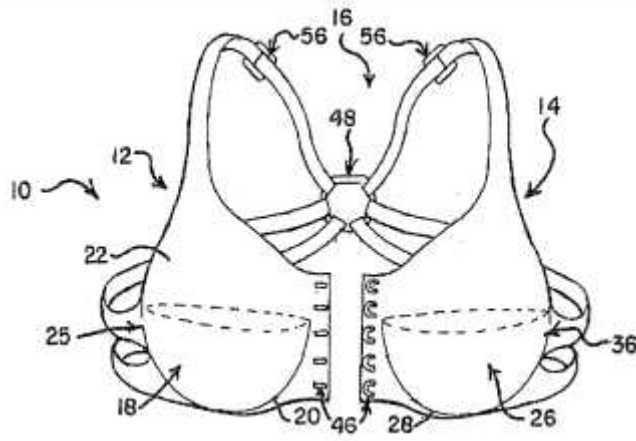

Special rules of classification

For back fasteners of brassieres class in [A41F 1/006](#)

A41C 3/04

for nursing mothers {(nursing clothing in general [A41D 1/215](#))}

Definition statement

This place covers:

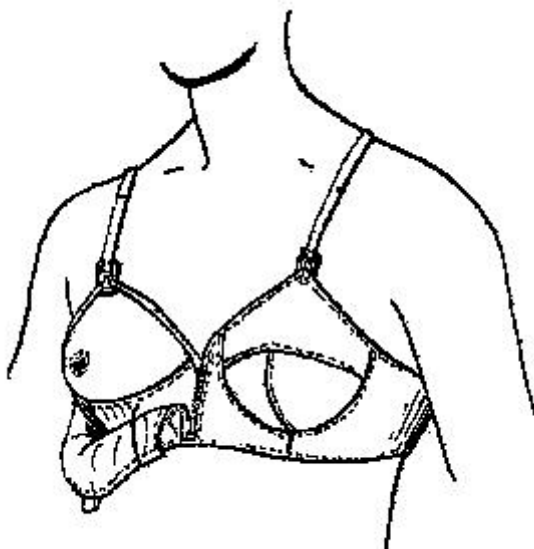

References

Informative references

Attention is drawn to the following places, which may be of interest for search:

Absorbent pads for breast / torso	A61F 13/14
Breast-nipple shields	A61J 13/00
Milking pumps	A61M 1/06
Suction cups for milking pumps	A61M 1/066
Supports of milk pumps on body	A61M 2209/088

A41C 3/06

Strapless brassieres, {i.e. without shoulder straps}

Definition statement

This place covers:

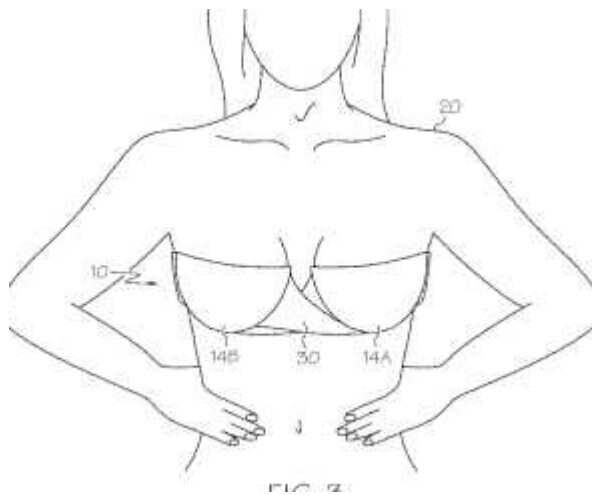

A41C 3/065

{attached directly to the body, e.g. by means of adhesive}

Definition statement

This place covers:

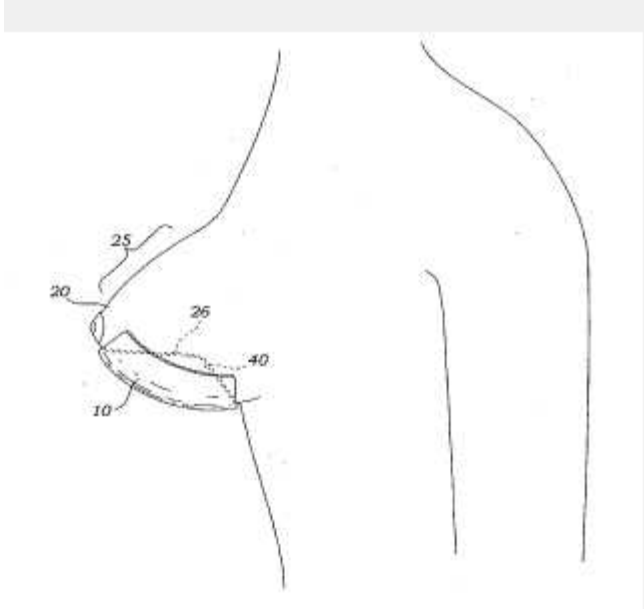
**References****Informative references**

Attention is drawn to the following places, which may be of interest for search:

Plasters for reconstructing body shape	A61F 2013/00382
Adhesive bandages or dressings	A61F 13/02
Bandages adapted to breast	A61F 13/14

A41C 3/08

combined with other garments (with corsets [A41C 1/06](#))

Definition statement

This place covers:

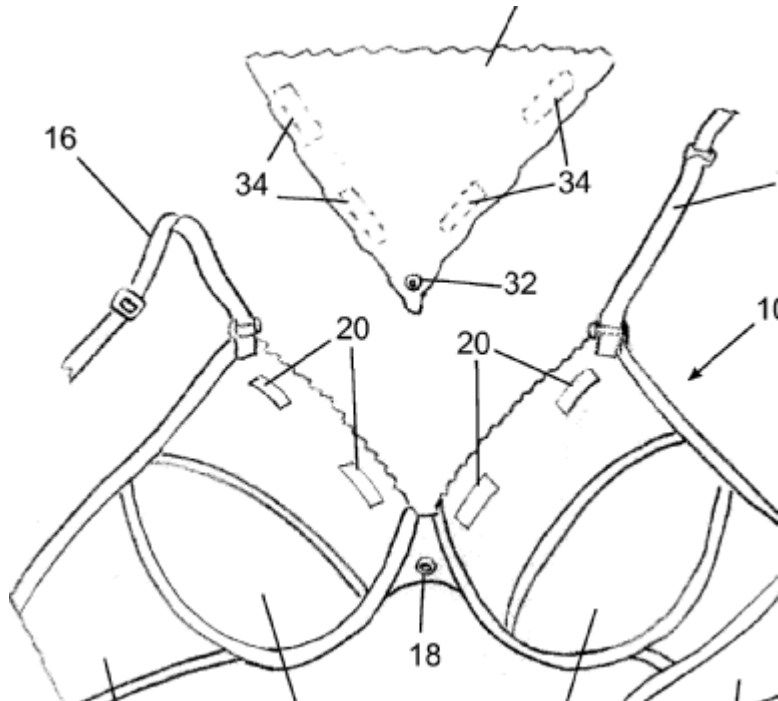
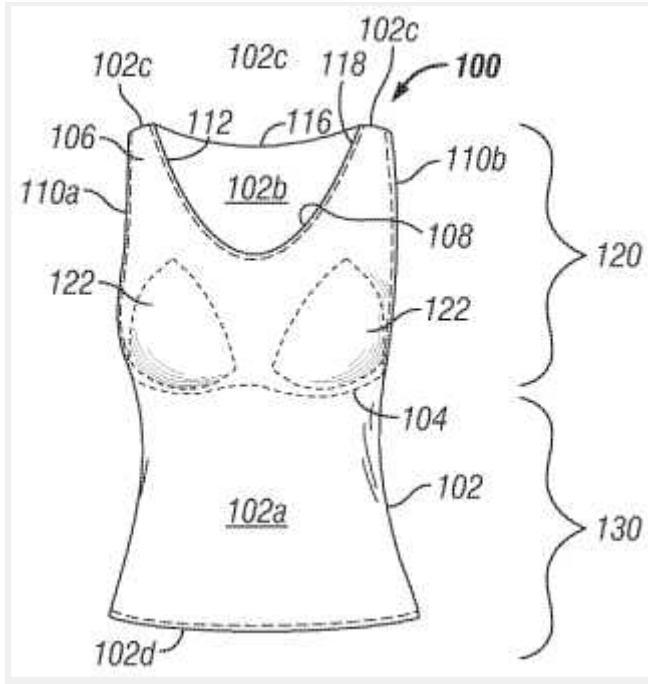
**References****Informative references**

Attention is drawn to the following places, which may be of interest for search:

Vests with features specially meant for women	A41D 1/18
---	---------------------------

Cleavage covers	A41D 1/22
-----------------	---------------------------

A41C 3/10

with stiffening or bust-forming inserts

Definition statement

This place covers:

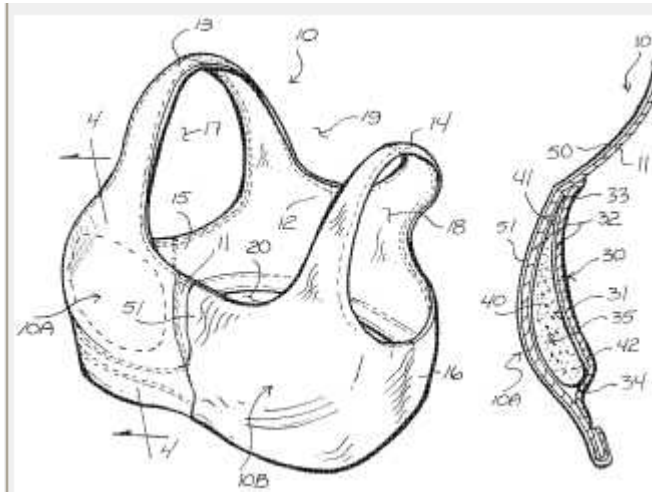

References

Informative references

Attention is drawn to the following places, which may be of interest for search:

Inserts per se	A41C 3/14
----------------	---------------------------

Special rules of classification

For brassieres with stiffening or bust-forming inserts, where the brassiere is also relevant, class in [A41C 3/10](#).

For stiffening or bust-forming inserts per se, which are supports covering the volumetric contour of the cup class in [A41C 3/14](#) and lower groups.

For stay means per se, which are wires and perimetric supports only around the linear contour of cup, class in [A41C 3/122](#) and lower groups.

For brassieres with stay means, where the brassiere is also relevant, class in [A41C 3/0007](#).

A41C 3/105

{with inflatable inserts}

Definition statement

This place covers:

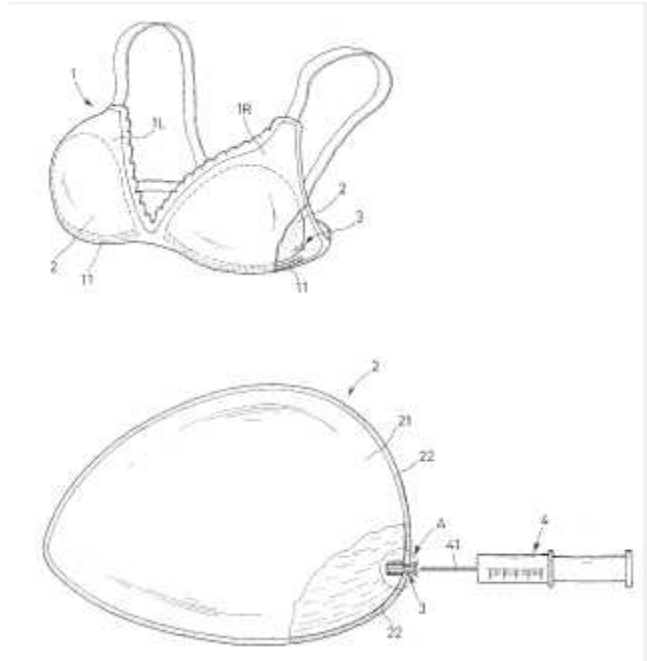

A41C 3/12

Component parts

Definition statement

This place covers:

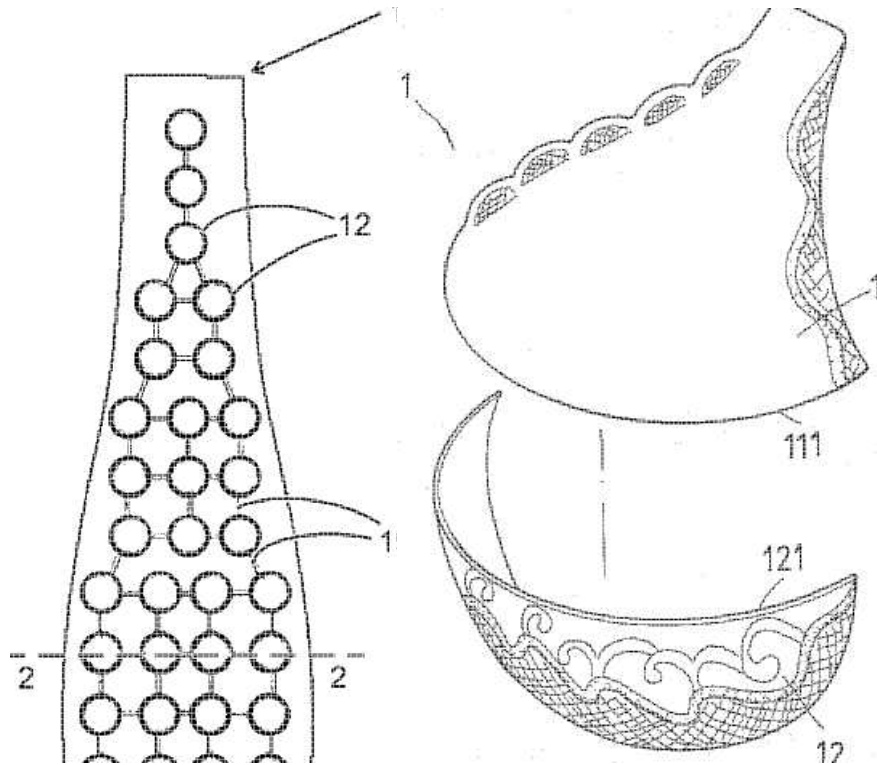

References

Informative references

Attention is drawn to the following places, which may be of interest for search:

Undergarments with integral shoulder straps	A41B 9/16
Brassiere back fasteners	A41F 1/006
Brassiere shoulder straps	A41F 15/00
Hook/eye fasteners	A44B 13/00

Special rules of classification

For stay means per se, which are wires and perimetric supports only around the linear contour of cup, class in [A41C 3/122](#) and lower groups.

For stiffening or bust-forming inserts per se, which are supports covering the volumetric contour of the cup class in [A41C 3/14](#) and lower groups.

For brassieres with stay means, where the brassiere is also relevant, class in [A41C 3/0007](#).

For brassieres with stiffening or bust-forming inserts, where the brassiere is also relevant, class in [A41C 3/10](#).

A41C 3/122

{Stay means (stay means for corsets [A41C 1/14](#))}

Definition statement

This place covers:

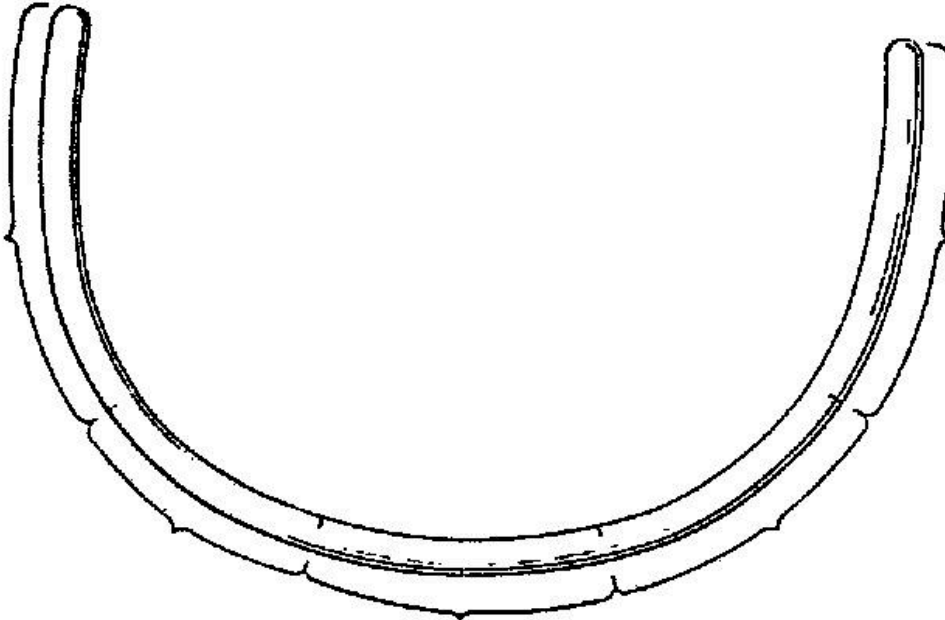
**Special rules of classification**

For stay means per se, which are wires and perimetric supports only around the linear contour of cup, class in [A41C 3/122](#) and lower groups.

For stiffening or bust-forming inserts per se, which are supports covering the volumetric contour of the cup class in [A41C 3/14](#) and lower groups.

For brassieres with stay means, where the brassiere is also relevant, class in [A41C 3/0007](#).

For brassieres with stiffening or bust-forming inserts, where the brassiere is also relevant, class in [A41C 3/10](#).

Glossary of terms

In this place, the following terms or expressions are used with the meaning indicated:

Stay means:	Wires and perimetric supports only around the linear contour of cup.
-------------	--

A41C 3/124

{with an articulated or bridge construction}

Definition statement

This place covers:

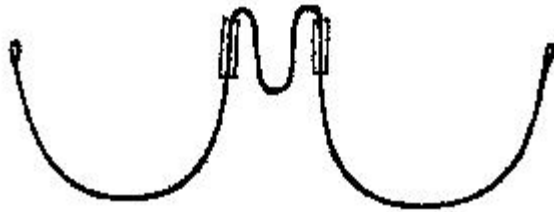

A41C 3/126

{with additional means provided at the ends, e.g. for protection}

Definition statement

This place covers:

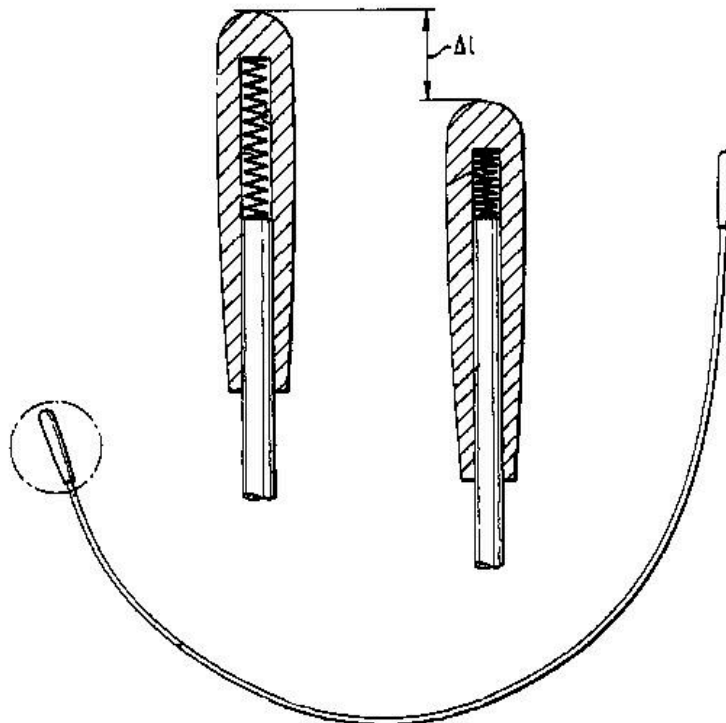

A41C 3/128

{using specific materials}

Definition statement

This place covers:

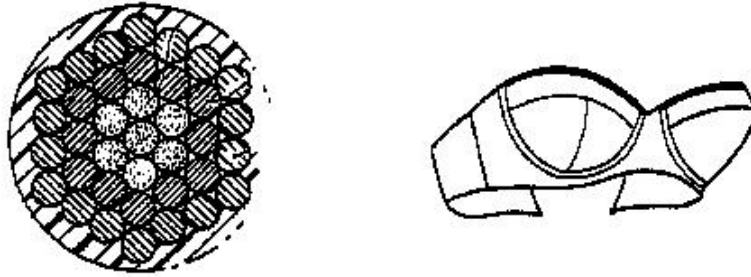

A41C 3/14

Stiffening or bust-forming inserts

Definition statement

This place covers:

30. [GB2396796](#) - Heat dissipating brassiere cup

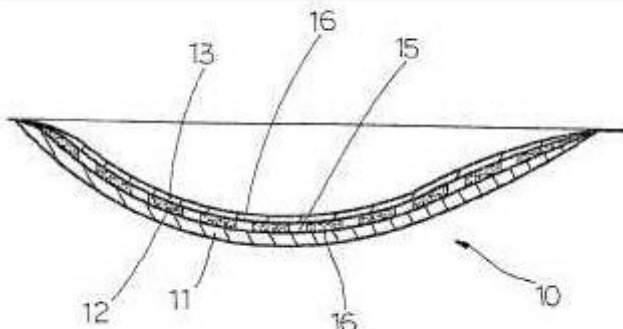
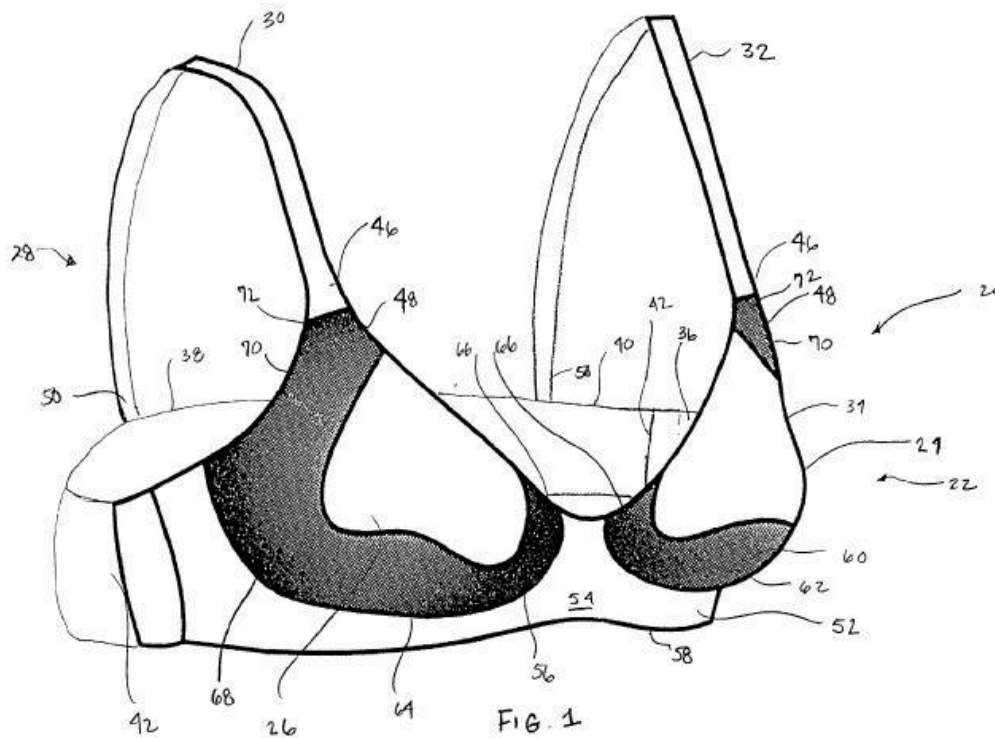

FIG. 7



Special rules of classification

For stiffening or bust-forming inserts per se, which are supports covering the volumetric contour of the cup class in [A41C 3/14](#) and lower groups.

For cup liners, cup surface reinforcement, cups with a layered structure where all of the volumetric contour of the cup is covered and for supports covering a continuous surface over most of the volumetric contour of the cup, class in [A41C 3/14](#).

For stay means per se, which are wires and perimetric supports only around the linear contour of cup, class in [A41C 3/122](#) and lower groups.

For brassieres with stiffening or bust-forming inserts, where the brassiere is also relevant, class in [A41C 3/10](#).

For brassieres with stay means, where the brassiere is also relevant, class in [A41C 3/0007](#).

For stiffening inserts, which are supports covering discrete parts of the volumetric contour of the cup, class in [A41C 3/142](#).

For pads, which are soft cushion-like supports or layers of material used as stuffing for filling out or expanding the bust shape, class in [A41C 3/144](#) and lower groups.

Glossary of terms

In this place, the following terms or expressions are used with the meaning indicated:

Stiffening or bust-forming inserts:	Supports covering the volumetric contour of the cup.
-------------------------------------	--

A41C 3/142

{Stiffening inserts}

Definition statement

This place covers:

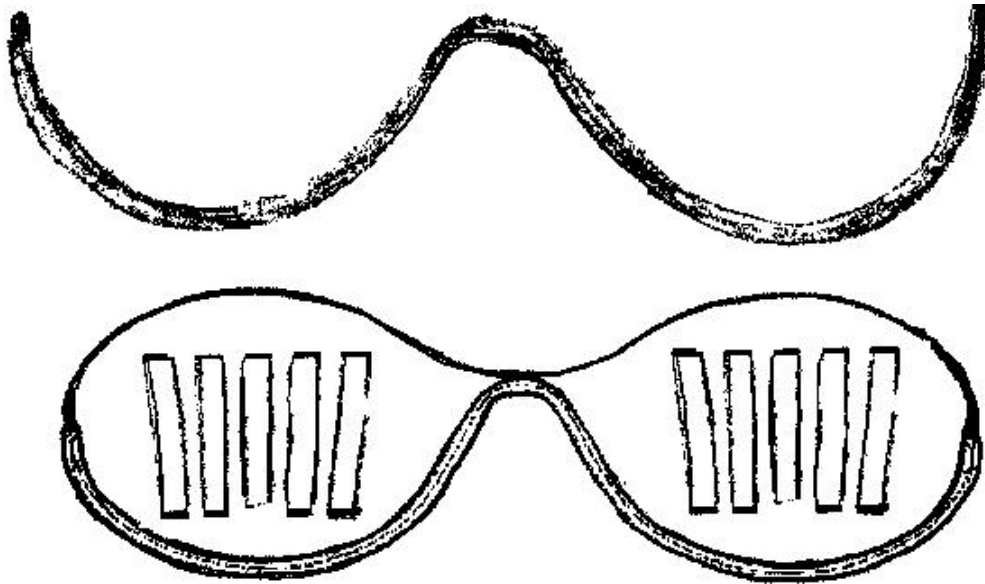

Special rules of classification

For stiffening inserts, which are supports covering discrete parts of the volumetric contour of the cup, class in [A41C 3/142](#).

For pads, which are soft cushion-like supports or layers of material used as stuffing for filling out or expanding the bust shape, class in [A41C 3/144](#) and lower groups.

For cup liners, cup surface reinforcement, cups with a layered structure where all of the volumetric contour of the cup is covered and for supports covering a continuous surface over most of the volumetric contour of the cup, class in [A41C 3/14](#).

Glossary of terms

In this place, the following terms or expressions are used with the meaning indicated:

Stiffening inserts:	Supports covering discrete parts of the volumetric contour of the cup.
---------------------	--

A41C 3/144

{Pads}

Definition statement

This place covers:

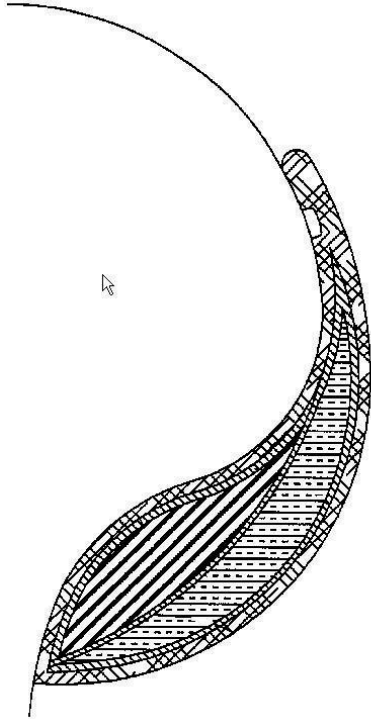

Special rules of classification

Comprises pads meant for the cup only.

For pads, which are soft cushion-like supports or layers of material used as stuffing for filling out or expanding the bust shape, class in [A41C 3/144](#) and lower groups.

For stiffening inserts, which are supports covering discrete parts of the volumetric contour of the cup, class in [A41C 3/142](#).

For cup liners, cup surface reinforcement, cups with a layered structure where all of the volumetric contour of the cup is covered and for supports covering a continuous surface over most of the volumetric contour of the cup, class in [A41C 3/14](#).

Glossary of terms

In this place, the following terms or expressions are used with the meaning indicated:

Pad	Soft cushion-like support or layers of material used as stuffing for filling out or expanding the bust shape.
-----	---

A41C 3/146

{containing liquid or gel filling}

Definition statement

This place covers:

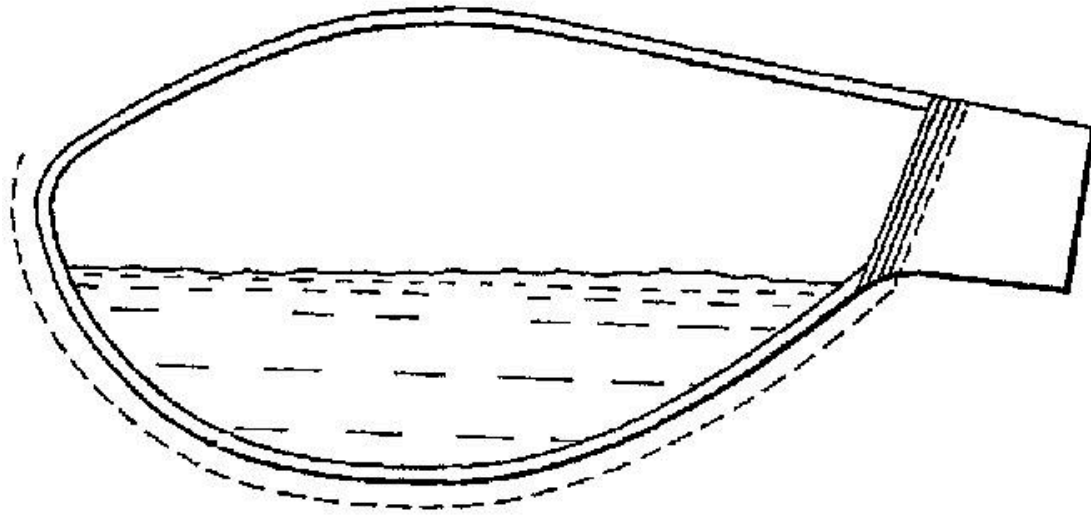

A41C 3/148

{Prosthetic brassieres (non-implantable mammary prostheses [A61F 2/52](#))}

Definition statement

This place covers:

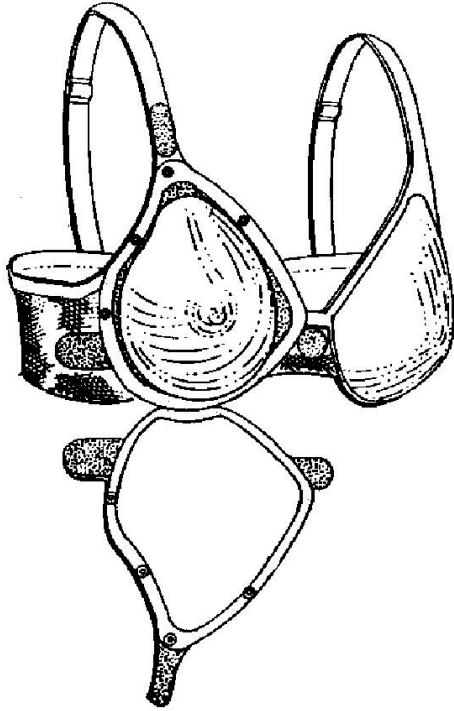

A41C 5/00

Machines, appliances, or methods for manufacturing corsets or brassieres

Definition statement

This place covers:

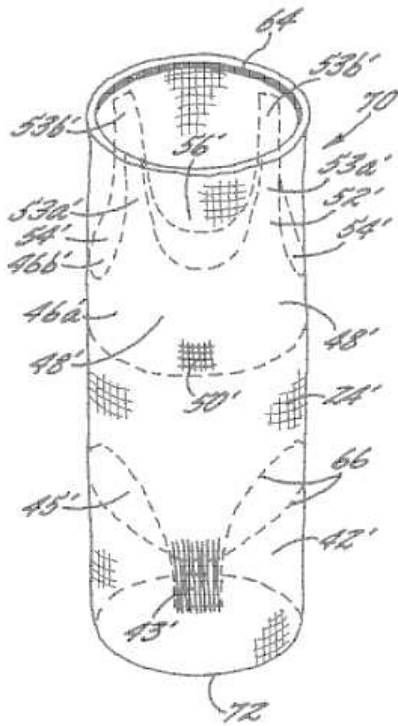

A41C 5/005

{by moulding (shaping of textile material made from plastics fibres by thermoforming [B29C 51/004](#))}

Definition statement

This place covers:

