

EUROPEAN PATENT OFFICE
U.S. PATENT AND TRADEMARK OFFICE

CPC NOTICE OF CHANGES 547

DATE: AUGUST 1, 2018

PROJECT RP0019

The following classification changes will be effected by this Notice of Changes:

<u>Action</u>	<u>Subclass</u>	<u>Group(s)</u>
SCHEME:		
Symbols Deleted:	A47C	7/022
Symbols New:	A47C	1/0303, 1/0305, 1/0307, 1/0308, 1/03274, 1/03279
	A47C	3/0251
	A47C	7/0213, 7/029, 7/142, 7/144, 7/444, 7/4454, 7/5062, 7/5064, 7/5066, 7/5068, 7/541, 7/622, 7/624, 7/626, 7/628, 7/664, 7/666, 7/705, 7/723, 7/727
Titles Changed:	A47	Class
	A47C	1/031, 1/03255, 1/03277, 1/034
	A47C	3/20
	A47C	7/14, 7/38, 7/383, 7/42, 7/445, 7/50, 7/68, 7/70
	A47C	27/00, 27/002, 27/08, 27/081, 27/085, 27/086, 27/087, 27/088, 27/121, 27/125, 27/144, 27/146
Warnings New:	A47C	1/03, 1/0303, 1/0305, 1/0307, 1/0308, 1/03261, 1/03266, 1/03272, 1/03274, 1/03277, 1/03279, 1/03283, 1/03288
	A47C	3/025, 3/0251, 3/0252, 3/0255, 3/0257, 3/026, 3/027
	A47C	7/021, 7/0213, 7/14, 7/142, 7/144, 7/44, 7/441, 7/443, 7/444, 7/445, 7/4454, 7/446, 7/448, 7/506, 7/5062, 7/5064, 7/5066, 7/5068, 7/54, 7/541, 7/543, 7/546, 7/62, 7/622, 7/624, 7/626, 7/628, 7/66, 7/664, 7/666, 7/70, 7/705, 7/72, 7/723, 7/727
Warnings Modified:	A47C	7/68
DEFINITIONS:		
Definitions New:	A47C	1/02, 1/03255, 1/03266
	A47C	7/021, 7/14, 7/441, 7/541, 7/624, 7/664
Definitions Modified:	A47C	Subclass
	A47C	1/00, 1/023, 1/024, 1/028, 1/03, 1/032, 1/034, 1/036, 1/04, 1/12, 1/14, 1/16
	A47C	3/00, 3/02, 3/04, 3/12, 3/14, 3/16, 3/20

CPC NOTICE OF CHANGES 547

DATE: AUGUST 1, 2018

PROJECT RP0019

<u>Action</u>	<u>Subclass</u>	<u>Group(s)</u>
	A47C	7/00, 7/002, 7/02, 7/38, 7/40, 7/402, 7/405, 7/407, 7/42, 7/44, 7/46, 7/48, 7/50, 7/54, 7/56, 7/62, 7/64, 7/66, 7/68, 7/72
	A47C	9/002
	A47C	27/00, 27/001, 27/002, 27/04, 27/081, 27/085, 27/086, 27/087, 27/088, 27/10, 27/12, 27/14, 27/22

The following subclasses/groups are also impacted by this Notice of Changes (indicate subclasses/groups outside of the project scope, such as those listed in the CRL):
A45B, B64D

This Notice of Changes includes the following [Check the ones included]:

1. CLASSIFICATION SCHEME CHANGES
 - A. New, Modified or Deleted Group(s)
 - B. New, Modified or Deleted Warning Notice(s)
 - C. New, Modified or Deleted Note(s)
 - D. New, Modified or Deleted Guidance Heading(s)
2. DEFINITIONS (New or Modified)
 - A. DEFINITIONS (Full definition template)
 - B. DEFINITIONS (Definitions Quick Fix)
3. REVISION CONCORDANCE LIST (RCL)
4. CHANGES TO THE CPC-TO-IPC CONCORDANCE LIST (CICL)
5. CROSS-REFERENCE LIST (CRL)

CPC NOTICE OF CHANGES 547

DATE: AUGUST 1, 2018

PROJECT RP0019

1. CLASSIFICATION SCHEME CHANGES

A. New, Modified or Deleted Group(s)

CLASS A47 - FURNITURE; DOMESTIC ARTICLES OR APPLIANCES; COFFEE MILLS; SPICE MILLS; SUCTION CLEANERS IN GENERAL

<u>Type*</u>	<u>Symbol</u>	<u>Indent Level Number of dots (e.g. 0, 1, 2)</u>	<u>Title (new or modified)</u> <u>“CPC only” text should normally be enclosed in {curly brackets}**</u>	<u>Transferred to#</u>
M	A47		FURNITURE; DOMESTIC ARTICLES OR APPLIANCES; COFFEE MILLS; SPICE MILLS; SUCTION CLEANERS IN GENERAL	

SUBCLASS A47C - CHAIRS (seats specially adapted for vehicles B60N 2/00); SOFAS; BEDS (upholstery in general B68G)

<u>Type*</u>	<u>Symbol</u>	<u>Indent Level Number of dots (e.g. 0, 1, 2)</u>	<u>Title (new or modified)</u> <u>“CPC only” text should normally be enclosed in {curly brackets}**</u>	<u>Transferred to#</u>
C	A47C1/03	3	the parts being arm-rests {(conversion into a bed A47C 17/12)}	A47C1/03, A47C1/0303, A47C1/0305, A47C1/0307, A47C1/0308, A47C7/541
N	A47C1/0303	4	{adjustable rectilinearly in vertical direction}	
N	A47C1/0305	5	{by peg-and-notch or pawl-and-ratchet mechanism}	
N	A47C1/0307	4	{adjustable rectilinearly in horizontal direction}	
N	A47C1/0308	4	{adjustable by rotation}	
M	A47C1/031	2	having coupled {concurrently} adjustable supporting parts	
M	A47C1/03255	4	{with a central column, e.g. rocking office chairs}	
C	A47C1/03261	4	{characterised by elastic means}	A47C1/03261, A47C1/03277, A47C1/03279
C	A47C1/03266	5	{with adjustable elasticity}	A47C1/03266, A47C1/03277, A47C1/03279
C	A47C1/03272	5	{with coil springs}	A47C1/03272, A47C1/03274
N	A47C1/03274	6	{of torsion type}	

CPC NOTICE OF CHANGES 547

DATE: AUGUST 1, 2018

PROJECT RP0019

Type*	Symbol	Indent Level Number of dots (e.g. 0, 1, 2)	Title (new or modified) "CPC only" text should normally be enclosed in {curly brackets}**	Transferred to#
C	A47C1/03277	5	{with bar or leaf springs}	A47C1/03277, A47C1/03279
N	A47C1/03279	6	{of torsion type}	
E	A47C1/03283	5	{with fluid springs}	
E	A47C1/03288	5	{with resilient blocks}	
M	A47C1/034	3	the parts including a leg-rest or foot-rest (A47C 1/037 takes precedence)	
C	A47C3/025	2	with seat, or seat and back-rest unit elastically {or pivotally} mounted in a rigid {base} frame	A47C3/025, A47C3/0251
N	A47C3/0251	3	{driven by electric motors}	
C	A47C3/0252	3	{connected only by an elastic member positioned between seat and base frame}	A47C3/0252, A47C3/0251
C	A47C3/0255	3	{pivotally mounted in the base frame, e.g. swings}	A47C3/0255, A47C3/0251
C	A47C3/0257	3	{slidingly movable in the base frame, e.g. by rollers}	A47C3/0257, A47C3/0251
C	A47C3/026	3	with central column, e.g. rocking office chairs; Tilting chairs	A47C3/026, A47C3/0251
C	A47C3/027	3	with curved rocking members between seat and {base} frame	A47C3/027, A47C3/0251
M	A47C3/20	1	Chairs or stools with vertically-adjustable seats (tables with variable height A47B 9/00)	
U	A47C7/02	1	Seat parts (adaptation of seats to mounting in tubular chairs A47C 5/06; such parts not restricted to chairs A47C 23/00; removable upholstered units or cushions A47C 27/00)	
C	A47C7/021	2	{Detachable or loose seat cushions}	A47C7/021, A47C7/0213
N	A47C7/0213	3	{detachably secured to seats, e.g. by ties or hook and loop straps}	
D	A47C7/022	2	{especially profiled for adaptation to body contour}	<administrative transfer to A47C7/029>
U	A47C7/028	3	{with wooden springs, e.g. slated type}	
N	A47C7/029	2	{of non-adjustable shape adapted to a user contour or ergonomic seating positions}	

CPC NOTICE OF CHANGES 547

DATE: AUGUST 1, 2018

PROJECT RP0019

Type*	Symbol	Indent Level Number of dots (e.g. 0, 1, 2)	Title (new or modified) "CPC only" text should normally be enclosed in {curly brackets}**	Transferred to#
C	A47C7/14	2	of adjustable shape; elastically mounted {; adaptable to a user contour or ergonomic seating positions (movably-coupled seat and backrests with elastic adjustment means A47C1/03261; elastically-mounted back-rests or backrest-seat units in the base frame A47C7/44)}	A47C7/14, A47C7/142 A47C7/144, A47C7/44, A47C7/441, A47C7/443, A47C7/444, A47C7/445, A47C7/4454, A47C7/446, A47C7/448, A47C1/03261, A47C1/03266, A47C1/03272, A47C1/03274, A47C1/03277, A47C1/03279, A47C1/03283, A47C1/03288
N	A47C7/142	3	{by fluid means}	
N	A47C7/144	3	{with array of movable supports}	
M	A47C7/38	2	for the head {(adjustable coupled to reclining or easy chairs A47C 1/036)}	
M	A47C7/383	3	{Detachable or loose head- or neck-supports, e.g. horse-shoe shaped}	
M	A47C7/42	3	of detachable {or loose} type	
C	A47C7/44	3	with elastically-mounted {back-rest or backrest-seat unit in the base} frame	A47C7/44, A47C 7/444, A47C 7/445, A47C7/4454
E	A47C 7/441	4	{with adjustable elasticity}	
C	A47C 7/443	4	{with coil springs}	A47C 7/443, A47C 7/444
N	A47C 7/444	5	{of torsion type}	
C	A47C 7/445	4	{with bar or leaf springs}	A47C7/445, A47C7/4454
N	A47C 7/4454	5	{of torsion type}	
E	A47C7/446	4	{with fluid springs}	
E	A47C 7/448	4	{with resilient blocks}	
M	A47C7/50	1	Supports for the feet or the legs {coupled to fixed parts of the chair} (coupled to other adjustable parts {of the reclining or easy chair} A47C1/034, A47C1/037; {stand-alone rests or supports for the feet or the legs, e.g.} footstools A47C16/02)	
C	A47C7/506	2	{of adjustable type}	A47C7/506, A47C7/5062, A47C7/5064, A47C7/5066, A47C7/5068
N	A47C 7/5062	3	{rectilinearly}	
N	A47C 7/5064	4	{in vertical direction}	
N	A47C 7/5066	3	{by rotation}	
N	A47C 7/5068	4	{actuated by linkages}	
C	A47C 7/54	1	Supports for the arms	A47C7/54, A47C7/541, A47C1/03, A47C1/0303, A47C1/0305, A47C1/0307, A47C1/0308

CPC NOTICE OF CHANGES 547

DATE: AUGUST 1, 2018

PROJECT RP0019

Type*	Symbol	Indent Level Number of dots (e.g. 0, 1, 2)	Title (new or modified) "CPC only" text should normally be enclosed in {curly brackets}**	Transferred to#
N	A47C 7/541	2	{of adjustable type (adjustable arm-rests of reclining or easy chairs A47C1/03)}	
C	A47C 7/543	2	{movable to inoperative position}	A47C7/543, A47C7/541, A47C1/03, A47C1/0303, A47C1/0305, A47C1/0307, A47C1/0308
C	A47C 7/546	2	{of detachable type}	A47C7/546, A47C7/541, A47C1/03, A47C1/0303, A47C1/0305, A47C1/0307, A47C1/0308
C	A47C 7/62	1	Accessories for chairs	A47C 7/62, A47C 7/622, A47C 7/624, A47C 7/626, A47C 7/628
N	A47C7/622	2	{Receptacles, e.g. cup holders, storage containers}	
N	A47C7/624	3	{located on side of seat, e.g. on armrest}	
N	A47C7/626	3	{directly under the seat}	
N	A47C7/628	4	{accessible by displacement of seat}	
C	A47C7/66	2	Means to protect against weather	A47C 7/66, A47C 7/664, A47C 7/666
N	A47C7/664	3	{of umbrella type}	
N	A47C7/666	3	{of enclosure type with side panels}	
C	A47C7/68	2	Arm-rest tables {; or back-rest tables}	A47C7/68, A47C7/622, A47C7/624, A47C7/626, A47C7/628
C	A47C 7/70	3	of foldable type	A47C7/70, A47C7/705, A47C7/622, A47C7/624, A47C7/626, A47C7/628
N	A47C 7/705	3	{of detachable type}	
C	A47C 7/72	2	Adaptations for incorporating lamps, radio sets, bars, telephones, ventilation, heating or cooling arrangements or the like	A47C7/72, A47C7/723, A47C7/727
N	A47C 7/723	3	{with display screens}	
U	A47C7/725	3	{for illumination, e.g. lamps}	
N	A47C 7/727	3	{with speakers}	
M	A47C27/00	0	Spring, stuffed or fluid mattresses {or cushions} specially adapted for chairs, beds or sofas	
M	A47C 27/002	1	{Mattress or cushion tickings or covers (bed linen, blankets or counterpanes A47G 9/02)}	

CPC NOTICE OF CHANGES 547

DATE: AUGUST 1, 2018

PROJECT RP0019

Type*	Symbol	Indent Level Number of dots (e.g. 0, 1, 2)	Title (new or modified) "CPC only" text should normally be enclosed in {curly brackets}**	Transferred to#
M	A47C 27/08	1	Fluid mattresses {or cushions} (connecting valves to inflatable elastic bodies B60C 29/00)	
M	A47C 27/081	2	{of pneumatic type}	
M	A47C 27/085	2	{of liquid type, e.g. filled with water or gel}	
M	A47C 27/086	2	{with fluid-like particles, e.g. filled with beads}	
M	A47C 27/087	2	{with means for connecting opposite sides, e.g. internal ties or strips}	
M	A47C 27/088	2	{incorporating elastic bodies, e.g. foam}	
M	A47C 27/121	2	{with different inlays}	
M	A47C 27/125	2	{with projections, depressions or cavities}	
M	A47C 27/144	3	{inside the mattress or cushion}	
M	A47C 27/146	3	{on the outside surface of the mattress or cushion}	

*N = new entries where reclassification into entries is involved; C = entries with modified file scope where reclassification of documents from the entries is involved; Q = new entries which are firstly populated with documents via administrative transfers from deleted (D) entries. Afterwards, the transferred documents into the Q entry will either stay or be moved to more appropriate entries, as determined by intellectual reclassification; E= existing entries with enlarged file scope, which receive documents from C or D entries, e.g. when a limiting reference is removed from the entry title; M = entries with no change to the file scope (no reclassification); D = deleted entries; F = frozen entries will be deleted once reclassification of documents from the entries is completed; U = entries that are unchanged.

NOTES:

- **No {curly brackets} are used for titles in CPC only subclasses, e.g. C12Y, A23Y; 2000 series symbol titles of groups found at the end of schemes (orthogonal codes); or the Y section titles. The {curly brackets} are used for 2000 series symbol titles found interspersed throughout the main trunk schemes (breakdown codes).
- For U groups, the minimum requirement is to include the U group located immediately prior to the N group or N group array, in order to show the N group hierarchy and improve the readability and understanding of the scheme. Always include the symbol, indent level and title of the U group in the table above.
- All entry types should be included in the scheme changes table above for better understanding of the overall scheme change picture. Symbol, indent level, and title are required for all types except "D" which requires only a symbol.
- #“Transferred to” column must be completed for all C, D, F, and Q type entries. F groups will be deleted once reclassification is completed.
- When multiple symbols are included in the “Transferred to” column, avoid using ranges of symbols in order to be as precise as possible.
- For administrative transfer of documents, the following text should be used: “< administrative transfer to XX>” or “<administrative transfer to XX and YY simultaneously>” when administrative transfer of the same documents is to more than one place.
- Administrative transfer to main trunk groups is assumed to be “invention information”, unless otherwise indicated, and to 2000 series groups is assumed to be “additional information”.

CPC NOTICE OF CHANGES 547

DATE: AUGUST 1, 2018

PROJECT RP0019

B. New, Modified or Deleted Warning notice(s)

SUBCLASS A47C - CHAIRS (seats specially adapted for vehicles B60N 2/00); SOFAS; BEDS (upholstery in general B68G)

<u>Type*</u>	<u>Location</u>	<u>Old Warning notice</u>	<u>New/Modified Warning notice</u>
N	A47C 1/03		Group A47C 1/03 is incomplete pending reclassification of documents from group A47C 7/54, A47C 7/543 and A47C 7/546. Group A47C 1/03 is also impacted by reclassification into groups A47C 1/0303, A47C 1/0305, A47C 1/0307, A47C 1/0308 and A47C 7/541. All groups listed in this Warning should be considered in order to perform a complete search.
N	A47C 1/0303		Group A47C 1/0303 is incomplete pending reclassification of documents from groups A47C 1/03, A47C 7/54, A47C 7/543 and A47C 7/546. All groups listed in this Warning should be considered in order to perform a complete search.
N	A47C 1/0305		Group A47C 1/0305 is incomplete pending reclassification of documents from groups A47C 1/03, A47C 7/54, A47C 7/543 and A47C 7/546. All groups listed in this Warning should be considered in order to perform a complete search.
N	A47C 1/0307		Group A47C 1/0307 is incomplete pending reclassification of documents from groups A47C 1/03, A47C 7/54, A47C 7/543 and A47C 7/546. All groups listed in this Warning should be considered in order to perform a complete search.
N	A47C 1/0308		Group A47C 1/0308 is incomplete pending reclassification of documents from groups A47C 1/03, A47C 7/54, A47C 7/543 and A47C 7/546. All groups listed in this Warning should be considered in order to perform a complete search.

CPC NOTICE OF CHANGES 547

DATE: AUGUST 1, 2018

PROJECT RP0019

<u>Type*</u>	<u>Location</u>	<u>Old Warning notice</u>	<u>New/Modified Warning notice</u>
N	A47C 1/03261		Group A47C 1/03261 is incomplete pending reclassification of documents from group A47C 7/14. Group A47C 1/03261 is also impacted by reclassification into groups A47C 1/03277 and A47C 1/03279. All groups listed in this Warning should be considered in order to perform a complete search.
N	A47C 1/03266		Group A47C 1/03266 is incomplete pending reclassification of documents from group A47C 7/14. Group A47C 1/03266 is also impacted by reclassification into groups A47C 1/03277 and A47C 1/03279. All groups listed in this Warning should be considered in order to perform a complete search.
N	A47C 1/03272		Group A47C 1/03272 is incomplete pending reclassification of documents from group A47C 7/14. Group A47C 1/03272 is also impacted by reclassification into group A47C 1/03274. Groups A47C 7/14, A47C 1/03272 and A47C 1/03274 should be considered in order to perform a complete search.
N	A47C 1/03274		Group A47C 1/03274 is incomplete pending reclassification of documents from groups A47C 1/03272 and A47C 7/14. Groups A47C 1/03272, A47C 7/14 and A47C 1/03274 should be considered in order to perform a complete search.
N	A47C 1/03277		Group A47C 1/03277 is incomplete pending reclassification of documents from groups A47C 1/03261, A47C 1/03266 and A47C 7/14. Group A47C 1/03277 is also impacted by reclassification into group A47C 1/03279. All groups listed in this Warning should be considered in order to perform a complete search.

CPC NOTICE OF CHANGES 547

DATE: AUGUST 1, 2018

PROJECT RP0019

<u>Type*</u>	<u>Location</u>	<u>Old Warning notice</u>	<u>New/Modified Warning notice</u>
N	A47C 1/03279		Group A47C 1/03279 is incomplete pending reclassification of documents from groups A47C 1/03261, A47C 1/03266, A47C 1/03277 and A47C 7/14. All groups listed in this Warning should be considered in order to perform a complete search.
N	A47C 1/03283		Group A47C 1/03283 is incomplete pending reclassification of documents from group A47C 7/14. Groups A47C 7/14 and A47C 1/03283 should be considered in order to perform a complete search.
N	A47C 1/03288		Group A47C 1/03288 is incomplete pending reclassification of documents from group A47C 7/14. Groups A47C 7/14 and A47C 1/03288 should be considered in order to perform a complete search.
N	A47C 3/025		Group A47C 3/025 is impacted by reclassification into group A47C 3/0251. Groups A47C 3/025 and A47C 3/0251 should be considered in order to perform a complete search.
N	A47C 3/0251		Group A47C 3/0251 is incomplete pending reclassification of documents from groups A47C 3/025, A47C 3/0252, A47C 3/0255, A47C 3/0257, A47C 3/026 and A47C 3/027. All groups listed in this Warning should be considered in order to perform a complete search.
N	A47C 3/0252		Group A47C 3/0252 is impacted by reclassification into group A47C 3/0251. Groups A47C 3/0252 and A47C 3/0251 should be considered in order to perform a complete search.
N	A47C 3/0255		Group A47C 3/0255 is impacted by reclassification into group A47C 3/0251. Groups A47C 3/0255 and A47C 3/0251 should be

CPC NOTICE OF CHANGES 547

DATE: AUGUST 1, 2018

PROJECT RP0019

<u>Type*</u>	<u>Location</u>	<u>Old Warning notice</u>	<u>New/Modified Warning notice</u>
			considered in order to perform a complete search.
N	A47C 3/0257		Group A47C 3/0257 is impacted by reclassification into group A47C 3/0251. Groups A47C 3/0257 and A47C 3/0251 should be considered in order to perform a complete search.
N	A47C 3/026		Group A47C 3/026 is impacted by reclassification into group A47C 3/0251. Groups A47C 3/026 and A47C 3/0251 should be considered in order to perform a complete search.
N	A47C 3/027		Group A47C 3/027 is impacted by reclassification into group A47C 3/0251. Groups A47C 3/027 and A47C 3/0251 should be considered in order to perform a complete search.
N	A47C 7/021		Group A47C 7/021 is impacted by reclassification into group A47C 7/0213. Groups A47C 7/021 and A47C 7/0213 should be considered in order to perform a complete search.
N	A47C 7/0213		Group A47C 7/0213 is incomplete pending reclassification of documents from group A47C 7/021. Groups A47C 7/021 and A47C 7/0213 should be considered in order to perform a complete search.
N	A47C 7/14		Group A47C 7/14 is impacted by reclassification into groups A47C 7/142, A47C 7/144, A47C 7/44, A47C7/441, A47C 7/443, A47C 7/444, A47C 7/445, A47C 7/4454, A47C 7/446, A47C 7/448, A47C 1/03261, A47C 1/03266, A47C 1/03272, A47C 1/03274, A47C 1/03277, A47C 1/03279, A47C 1/03283 and A47C 1/03288. All groups listed in this Warning should be considered in order to perform a complete search.

CPC NOTICE OF CHANGES 547

DATE: AUGUST 1, 2018

PROJECT RP0019

<u>Type*</u>	<u>Location</u>	<u>Old Warning notice</u>	<u>New/Modified Warning notice</u>
N	A47C 7/142		Group A47C 7/142 is incomplete pending reclassification of documents from group A47C 7/14. Groups A47C 7/14 and A47C 7/142 should be considered in order to perform a complete search.
N	A47C 7/144		Group A47C 7/144 is incomplete pending reclassification of documents from group A47C 7/14. Groups A47C 7/14 and A47C 7/144 should be considered in order to perform a complete search.
N	A47C 7/44		Group A47C 7/44 is incomplete pending reclassification of documents from group A47C 7/14. Group A47C 7/44 is also impacted by reclassification into groups A47C 7/444, A47C 7/445 and A47C 7/4454. All groups listed in this Warning should be considered in order to perform a complete search.
N	A47C 7/441		Group A47C 7/441 is incomplete pending reclassification of documents from group A47C 7/14. Groups A47C 7/14 and A47C 7/441 should be considered in order to perform a complete search.
N	A47C 7/443		Group A47C 7/443 is incomplete pending reclassification of documents from group A47C 7/14. Group A47C 7/443 is also impacted by reclassification into group A47C 7/444. Groups A47C 7/14, A47C 7/443 and A47C 7/444 should be considered in order to perform a complete search.
N	A47C 7/444		Group A47C 7/444 is incomplete pending reclassification of documents from groups A47C 7/14, A47C 7/44 and A47C 7/443. All groups listed in this Warning should be considered in order to perform a complete search.

CPC NOTICE OF CHANGES 547

DATE: AUGUST 1, 2018

PROJECT RP0019

<u>Type*</u>	<u>Location</u>	<u>Old Warning notice</u>	<u>New/Modified Warning notice</u>
N	A47C 7/445		Group A47C 7/445 is incomplete pending reclassification of documents from groups A47C 7/14 and A47C 7/44. Group A47C 7/445 is also impacted by reclassification into group A47C 7/4454. All groups listed in this Warning should be considered in order to perform a complete search.
N	A47C 7/4454		Group A47C 7/4454 is incomplete pending reclassification of documents from groups A47C 7/14, A47C 7/44 and A47C 7/445. All groups listed in this Warning should be considered in order to perform a complete search.
N	A47C 7/446		Group A47C 7/446 is incomplete pending reclassification of documents from group A47C 7/14. Groups A47C 7/14 and A47C 7/446 should be considered in order to perform a complete search.
N	A47C 7/448		Group A47C 7/448 is incomplete pending reclassification of documents from group A47C 7/14. Groups A47C 7/14 and A47C 7/448 should be considered in order to perform a complete search.
N	A47C 7/506		Group A47C 7/506 is impacted by reclassification into groups A47C 7/5062, A47C 7/5064, A47C 7/5066 and A47C 7/5068. All groups listed in this Warning should be considered in order to perform a complete search.
N	A47C 7/5062		Group A47C 7/5062 is incomplete pending reclassification of documents from group A47C 7/506. Groups A47C 7/506 and A47C 7/5062 should be considered in order to perform a complete search.
N	A47C 7/5064		Group A47C 7/5064 is incomplete pending reclassification of documents from group A47C 7/506. Groups A47C 7/506 and A47C 7/5064 should be considered

CPC NOTICE OF CHANGES 547

DATE: AUGUST 1, 2018

PROJECT RP0019

<u>Type*</u>	<u>Location</u>	<u>Old Warning notice</u>	<u>New/Modified Warning notice</u>
			in order to perform a complete search.
N	A47C 7/5066		Group A47C 7/5066 is incomplete pending reclassification of documents from group A47C 7/506. Groups A47C 7/506 and A47C 7/5066 should be considered in order to perform a complete search.
N	A47C 7/5068		Group A47C 7/5068 is incomplete pending reclassification of documents from group A47C 7/506. Groups A47C 7/506 and A47C 7/5068 should be considered in order to perform a complete search.
N	A47C 7/54		Group A47C 7/54 is impacted by reclassification into groups A47C 7/541, A47C 1/03, A47C 1/0303, A47C 1/0305, A47C 1/0307 and A47C 1/0308. All groups listed in this Warning should be considered in order to perform a complete search.
N	A47C 7/541		Group A47C 7/541 is incomplete pending reclassification of documents from groups A47C 1/03, A47C 7/54, A47C 7/543 and A47C 7/546. All groups listed in this Warning should be considered in order to perform a complete search.
N	A47C 7/543		Group A47C 7/543 is impacted by reclassification into groups A47C 7/541, A47C 1/03, A47C 1/0303, A47C 1/0305, A47C 1/0307 and A47C 1/0308. All groups listed in this Warning should be considered in order to perform a complete search.
N	A47C 7/546		Group A47C 7/546 is impacted by reclassification into groups A47C 7/541, A47C 1/03, A47C 1/0303, A47C 1/0305, A47C 1/0307 and A47C 1/0308. All groups listed in this Warning should be considered in order to perform a complete search.

CPC NOTICE OF CHANGES 547

DATE: AUGUST 1, 2018

PROJECT RP0019

<u>Type*</u>	<u>Location</u>	<u>Old Warning notice</u>	<u>New/Modified Warning notice</u>
N	A47C 7/62		Group A47C 7/62 is impacted by reclassification into groups A47C 7/622, A47C 7/624, A47C 7/626 and A47C 7/628. All groups listed in this Warning should be considered in order to perform a complete search.
N	A47C 7/622		Group A47C 7/622 is incomplete pending reclassification of documents from groups A47C 7/62, A47C 7/68 and A47C 7/70. All groups listed in this Warning should be considered in order to perform a complete search.
N	A47C 7/624		Group A47C 7/624 is incomplete pending reclassification of documents from groups A47C 7/62, A47C 7/68 and A47C 7/70. All groups listed in this Warning should be considered in order to perform a complete search.
N	A47C 7/626		Group A47C 7/626 is incomplete pending reclassification of documents from groups A47C 7/62, A47C 7/68 and A47C 7/70. All groups listed in this Warning should be considered in order to perform a complete search.
N	A47C 7/628		Group A47C 7/628 is incomplete pending reclassification of documents from groups A47C 7/62, A47C 7/68 and A47C 7/70. All groups listed in this Warning should be considered in order to perform a complete search.
N	A47C 7/66		Group A47C 7/66 is impacted by reclassification into groups A47C 7/664 and A47C 7/666. Groups A47C 7/66, A47C 7/664 and A47C 7/666 should be considered in order to perform a complete search.
N	A47C 7/664		Group A47C 7/664 is incomplete pending reclassification of documents from group A47C 7/66. Groups A47C 7/66 and A47C 7/664 should be considered in order to perform a complete search.

CPC NOTICE OF CHANGES 547

DATE: AUGUST 1, 2018

PROJECT RP0019

<u>Type*</u>	<u>Location</u>	<u>Old Warning notice</u>	<u>New/Modified Warning notice</u>
N	A47C 7/666		Group A47C 7/666 is incomplete pending reclassification of documents from group A47C 7/66. Groups A47C 7/66 and A47C 7/666 should be considered in order to perform a complete search.
M	A47C 7/68	Group A47C 7/68 is incomplete pending reclassification of documents from group A47B39/00. Groups A47B39/00 and A47C7/68 should be considered in order to perform a complete search.	Group A47C 7/68 is incomplete pending reclassification of documents from group A47B39/00. Group A47C 7/68 is also impacted by reclassification into groups A47C 7/622, A47C 7/624, A47C 7/626 and A47C 7/628. All groups listed in this Warning should be considered in order to perform a complete search.
N	A47C 7/70		Group A47C 7/70 is impacted by reclassification into groups A47C 7/705, A47C 7/622, A47C 7/624, A47C 7/626 and A47C 7/628. All groups listed in this Warning should be considered in order to perform a complete search.
N	A47C 7/705		Group A47C 7/705 is incomplete pending reclassification of documents from group A47C 7/70. Groups A47C 7/70 and A47C 7/705 should be considered in order to perform a complete search.
N	A47C 7/72		Group A47C 7/72 is impacted by reclassification into groups A47C 7/723 and A47C 7/727. Groups A47C 7/72, A47C 7/723 and A47C 7/727 should be considered in order to perform a complete search.
N	A47C 7/723		Group A47C 7/723 is incomplete pending reclassification of documents from group A47C 7/72. Groups A47C 7/72 and A47C 7/723 should be considered in order to perform a complete search.
N	A47C 7/727		Group A47C 7/727 is incomplete pending reclassification of documents from group A47C 7/72. Groups A47C 7/72 and A47C 7/727 should be considered in order to perform a complete search.

CPC NOTICE OF CHANGES 547

DATE: AUGUST 1, 2018

PROJECT RP0019

*N = new warning, M = modified warning, D = deleted warning

NOTE: The "Location" column only requires the symbol PRIOR to the location of the warning. No further directions such as "before" or "after" are required.

DATE: AUGUST 1, 2018

PROJECT RP0019

2. A. DEFINITIONS (new)

Insert: The following new Definitions.

A47C 1/02

References

Informative references

Attention is drawn to the following places, which may be of interest for search:

Support for the head or the back	A47C 7/36
Support for the feet or legs	A47C 7/50
Supports for the arms	A47C 7/54

Special rules of classification

References A47C 7/36, A47C 7/50 and A47C 7/54 are non-limiting in the subgroup A47C1/02. CPC will be updated/corrected once this inconsistency is resolved.

A47C 1/03255

Informative references

Attention is drawn to the following places, which may be of interest for search:

Seat and back-rest not movably coupled	A47C 3/026
--	----------------------------

A47C 1/03266

Special rules of classification

Applications classified here that use elastic components must also be classified under the type of spring used.

DATE: AUGUST 1, 2018

PROJECT RP0019

A47C 7/021

Definition statement

This place covers:

Illustrative examples of subject matter classified in this group:

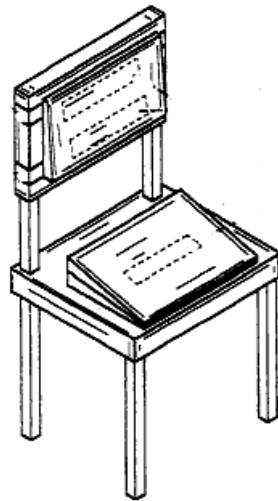
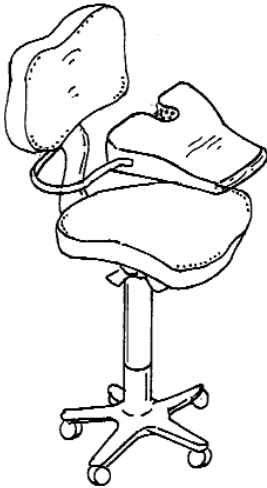

DATE: AUGUST 1, 2018

PROJECT RP0019

A47C 7/14

References

Limiting references

This place does not cover:

Movably-coupled seat and backrests with elastic adjustment means	A47C 1/03261
Elastically-mounted backrests or backrest-seat units in the base frame	A47C 7/44

A47C 7/441

Special rules of classification

Applications classified here that use elastic components must also be classified under the type of spring used.

A47C 7/541

Definition statement

This place covers:

Arm-rests adjustable to multiple use positions.

References

Limiting references

This place does not cover:

Adjustable armrests for reclining or easy chairs	A47C 1/03
--	---------------------------

DATE: AUGUST 1, 2018

PROJECT RP0019

A47C 7/624

Definition statement

This place covers:

Illustrative examples of subject matter classified in this group:

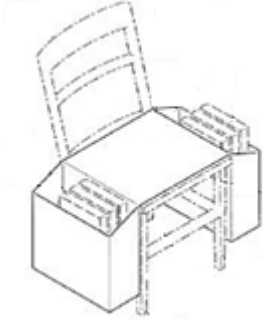

A47C 7/664

Definition statement

This place covers:

Umbrellas to be used in combination with a chair.



DATE: AUGUST 1, 2018

PROJECT RP0019

Informative references

Attention is drawn to the following places, which may be of interest for search:

Umbrellas characterised by attachment type or shape	A45B 11/00
---	----------------------------

2. A. DEFINITIONS (modified)

A47C 1/023

Definition statement

Replace: The existing figure with the following.

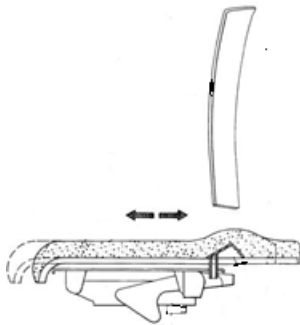

Delete: The caption WO0170072.

References

Delete: The entire Limiting references section.

Insert: The following new Application-oriented references section.

Application-oriented references

Examples of places where the subject matter of this place is covered when specially adapted, used for a particular purpose, or incorporated in a larger system:

Chairs for disabled persons having adjustable depth seats	A61G 5/1064
Adjustable vehicles seat-cushion length	B60N 2/0284

A47C 1/024

Definition statement

Replace: The existing figure with the following.

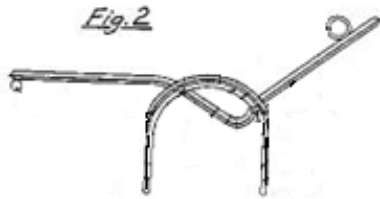
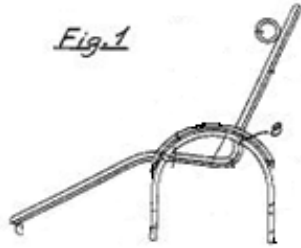

Delete: The caption WO9419991.

Replace: The existing figure with the following.

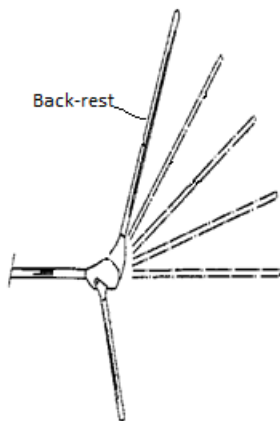

Delete: The caption FR2094463.

DATE: AUGUST 1, 2018

PROJECT RP0019

Limiting references

Delete: The entire Limiting references section.

Insert: The following new Application-oriented references section.

Application-oriented references

Examples of places where the subject matter of this place is covered when specially adapted, used for a particular purpose, or incorporated in a larger system:

Adjustable children's chairs	A47D 1/002
Vehicle seats with adjustable backrest	B60N 2/22

Informative references

Insert: The following four new references in the Informative references table.

Chairs having movably-coupled adjustable seat and backrest	A47C 1/032
Chairs having adjustable leg-rest or foot-rest connected to movable backrest or backrest-seat-unit	A47C 1/0342
Rocking chairs with central column and with backrest-seat-unit elastically mounted in a ridged frame	A47C 3/026
Seating furniture convertible to bed by tilting or pivoting the back-rest	A47C 17/16

A47C 1/03

Definition statement

Replace: The existing figure with the following.

DATE: AUGUST 1, 2018

PROJECT RP0019

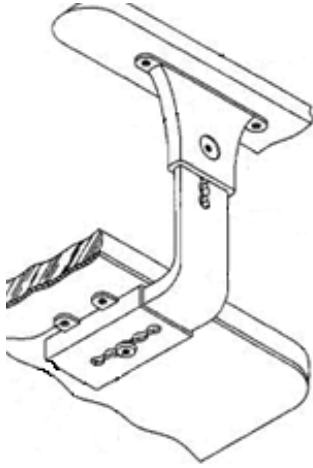

Delete: The caption US6296313.

References

Limiting references

Delete: All references in the Limiting references table except the third row, as shown.

Sofas convertible to bed by tilting or extending the armrests	A47C 17/12
---	----------------------------

Insert: The following new Application-oriented references section.

Application-oriented references

Examples of places where the subject matter of this place is covered when specially adapted, used for a particular purpose, or incorporated in a larger system:

Armrest for disabled persons' chairs	A61G 5/125
Armrest for vehicles seats	B60N 2/75

DATE: AUGUST 1, 2018

PROJECT RP0019

Insert: The following new Informative references section.

Informative references

Attention is drawn to the following places, which may be of interest for search:

Arm supports for non-reclining and non-easy chairs	A47C 7/54
Chairs with armrest tables	A47C 7/68
Sofa convertible to bed by tilting or pivoting a backrest with tilting or pivoting the armrest	A47C 17/18

A47C 1/032

Definition statement

Replace: The existing figure with the following.

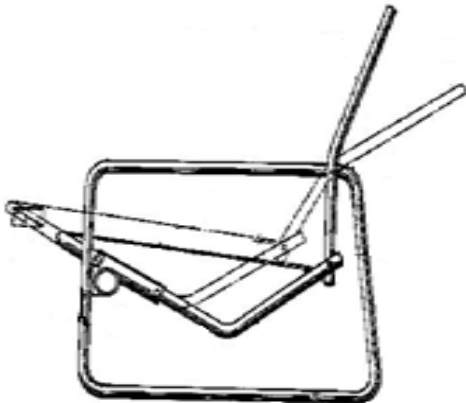

Delete: The caption EP189915.

DATE: AUGUST 1, 2018

PROJECT RP0019

Replace: The existing figure with the following.

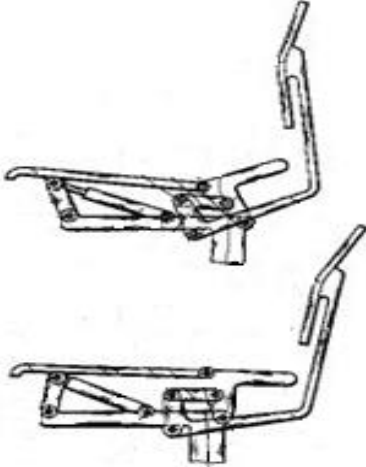

Delete: The caption EP247312.

Replace: The existing figure with the following.



Delete: The caption GN1202658.

DATE: AUGUST 1, 2018

PROJECT RP0019

References**Limiting references**

Delete: All references in the Limiting references table except the second row, as shown.

Chairs having adjustable leg-rest or foot-rest connected to movable-coupled seat and backrest	A47C 1/035
---	----------------------------

Insert: The following new Application-oriented references section.

Application-oriented references

Examples of places where the subject matter of this place is covered when specially adapted, used for a particular purpose, or incorporated in a larger system:

Adjustable children's chairs	A47D 1/002
Vehicle seats with adjustable backrest	B60N 2/22

Insert: The following new Informative references section.

Informative references

Attention is drawn to the following places, which may be of interest for search:

Chairs having independently-adjustable supporting parts, e.g. having independently-adjustable backrest, backrest-seat-unit	A47C 1/022
Rocking office chairs with central column having seat or seat and back-rest unit elastically or pivotally mounted in a rigid base frame	A47C 3/026

DATE: AUGUST 1, 2018

PROJECT RP0019

Chairs with elastically-mounted backrest or backrest-seat-unit in the base frame	A47C 7/44
Adjustable children's chairs	A47D 1/002
Vehicle seats with adjustable backrest	B60N 2/22

A47C 1/036

Definition statement

Replace: The existing figure with the following.

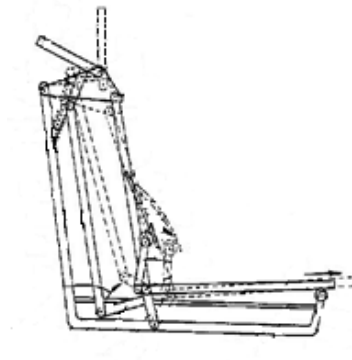

Delete: The caption EP277870.

References

Delete: The entire Limiting references section.

Insert: The following new Application-oriented references section.

Application-oriented references

Examples of places where the subject matter of this place is covered when specially adapted, used for a particular purpose, or incorporated in a larger system:

Head-rests for disabled persons' chairs	A61G 5/121
Head rest for operating or dental chairs	A61G 15/125
Head-rests for vehicle seats	B60N 2/80

DATE: AUGUST 1, 2018

PROJECT RP0019

Insert: The following new reference in the Informative references section.

Informative references

Head-rests connected to non-movable parts of the chair	A47C 7/38
--	---------------------------

A47C 1/04

Definition statement

Replace: The existing figure with the following.

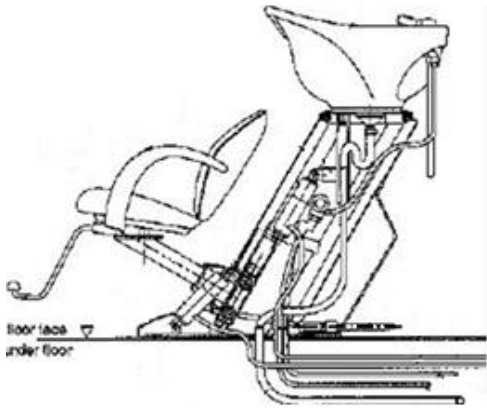

A47C 1/12

Definition statement

Insert: A comma after “theatres”, as shown below.

Chairs used in theatres, auditoriums, or stadiums

DATE: AUGUST 1, 2018

PROJECT RP0019

Replace: The existing figure with the following.

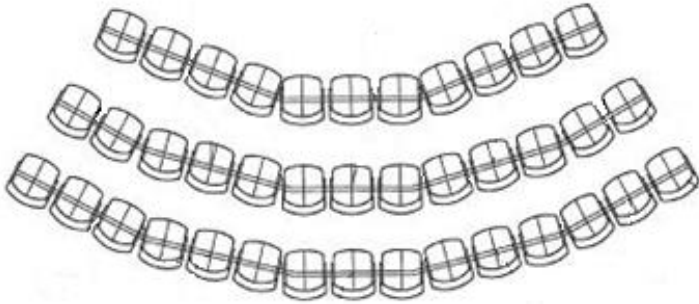

Delete: The caption WO2005110157.

References

Limiting references

Replace: The existing Limiting references table with the following.

Chairs or seats detachably mounted on stadium benches	A47C 1/16
---	---------------------------

Replace: The existing Informative references table with the following.

Informative references

Stackable chairs, Nesting chairs	A47C 3/04
Parts or details of tipping-up chairs, e.g. of theatre chairs	A47C 7/56
Benches	A47C 11/00
Modular seating	A47C 13/005
Tribunes, grandstands, terraces or amphitheatres for spectators	E04H 3/12

DATE: AUGUST 1, 2018

PROJECT RP0019

Auditoriums	E04H 3/30
Coin-freed apparatus for seats or footstools	G07F 17/08

A47C 1/14

Definition statement

Replace: In the Definition statement the word “longues” with “lounges”, as shown below.

Chairs designed for relaxation and outdoor use, e.g. beach chairs, relaxation chairs, sun-tanning chairs or chaise lounges.

Replace: The existing figure with the following.

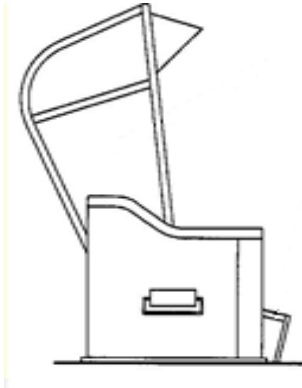

Delete: The caption DE202006002291U.

DATE: AUGUST 1, 2018

PROJECT RP0019

Replace: The existing figure with the following.



Delete: The caption US6761397.

Replace: The existing figure with the following.



Delete: The caption DE926195.

References

Delete: The entire Limiting references section.

DATE: AUGUST 1, 2018

PROJECT RP0019

Informative references

Insert: The following three new references in the Informative references table.

Chairs with means to protect against weather	A47C 7/66
Camp, travelling, or sports stools	A47C 9/10
Stand-alone backrests without connected seat	A47C 16/005

A47C 1/16

Definition statement

Replace: The existing figure with the following.

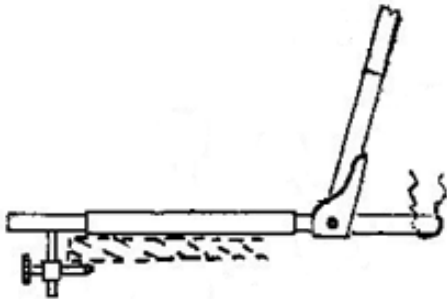

Delete: The caption FR2059821.

References

Limiting references

Delete: The first two rows of the Limiting references table; keep the row shown below.

Detachably mounted children's chairs	A47D 1/10
--------------------------------------	-----------

DATE: AUGUST 1, 2018

PROJECT RP0019

Insert: The following new Informative references section.

Informative references

Attention is drawn to the following places, which may be of interest for search:

Theatre, auditorium, or similar chairs	A47C 1/12
Detachable or loose seat cushions	A47C 7/021

A47C 3/04

Definition statement

Replace: The existing figure with the following.



Delete: The caption EP1468634.

Replace: The existing figure with the following.

DATE: AUGUST 1, 2018

PROJECT RP0019

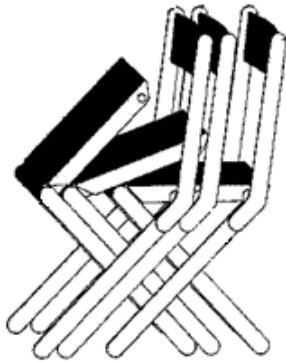

Delete: The caption FR2877821.

A47C 3/12

Definition statement

Replace: The existing figure with the following.



Delete: The caption WO2005102111.

References

Delete: The entire Limiting references section.

DATE: AUGUST 1, 2018

PROJECT RP0019

Insert: The following new Application-oriented references section.

Application-oriented references

Examples of places where the subject matter of this place is covered when specially adapted, used for a particular purpose, or incorporated in a larger system:

Shell shaped bus seats	B60N 2/242
------------------------	------------

Informative references

Replace: The term “chars” with “chairs” (as done below) in the first row of the Informative references table.

Basket chairs	A47C 5/02
---------------	-----------

A47C 3/14

Definition statement

Replace: The existing figure with the following.



Delete: The caption DE20210397U.

DATE: AUGUST 1, 2018

PROJECT RP0019

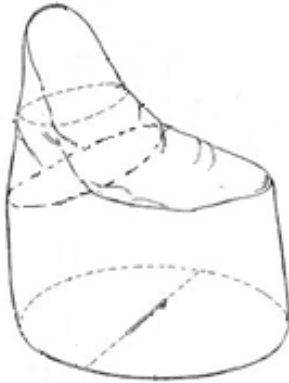
A47C 3/16**Definition statement**Replace: The existing figure with the following.Delete: The caption DE202004003245U.**Limiting references**Replace: The existing Limiting references table with the following.

Legless beach chairs	A47C 1/146
Chairs or seats detachably mounted on the stadium benches	A47C 1/16
Chairs of asymmetrical shape	A47C 3/14
Inflatable chairs	A47C 4/54

DATE: AUGUST 1, 2018

PROJECT RP0019

Insert: The following new Application-oriented references section.

Application-oriented references

Examples of places where the subject matter of this place is covered when specially adapted, used for a particular purpose, or incorporated in a larger system:

Children's chairs capable of being suspended from tables or adult's chair	A47D 1/10
---	-----------

A47C 3/20

Definition statement

Replace: The existing figure with the following.

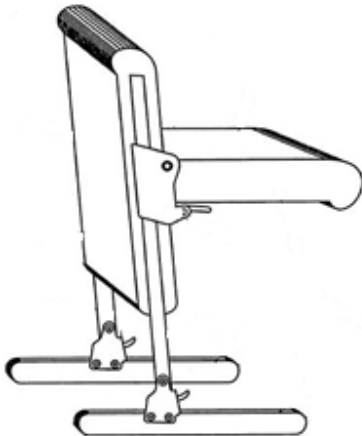

Delete: The caption WO03020078.

Replace: The existing figure with the following.

DATE: AUGUST 1, 2018

PROJECT RP0019

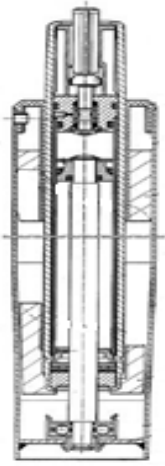

Delete: The caption DE19528645.

Replace: The existing figure with the following.

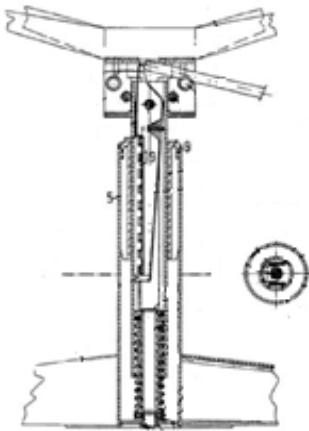

Delete: The caption BE864805.

DATE: AUGUST 1, 2018

PROJECT RP0019

Limiting references

Delete: The entire Limiting references section.

Insert: The following new Application-oriented references section.

Application-oriented references

Examples of places where the subject matter of this place is covered when specially adapted, used for a particular purpose, or incorporated in a larger system:

Height adjustable children's chairs	A47D 1/004
Chairs for disabled persons having adjustable height	A61G 5/1059

Informative references

Replace: The existing Informative references table with the following.

Table with variable heights	A47B 9/00
Stools for specified purposes	A47C 9/00
Locking of telescopic system in general	F16B 7/10

Insert: The following new Special rules of classification section.

Special rules of classification

Reference [A47B 9/00](#) is non-limiting in the subgroup [A47C3/20](#). CPC will be updated/corrected once this inconsistency is resolved.

DATE: AUGUST 1, 2018

PROJECT RP0019

A47C 7/002

Definition statement

Replace: The existing figure with the following.



Replace: The existing figure with the following.

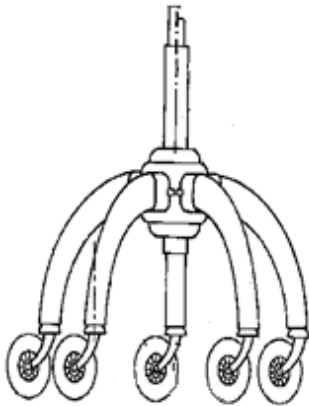

References

Limiting references

Delete: All rows except the second row (shown below) of the Limiting references table.

Chairs or stools with vertically-adjustable seats	A47C 3/20
---	-----------

Informative references

Insert: The following four new rows in the Informative references table.

Feet for furniture in general	A47B 91/00
Reclining chairs by changing the length or inclination of the legs	A47C 1/029
Bedsteads' legs	A47C 19/024
Castors in general	B60B 33/00

A47C 7/38

Definition statement

Replace: The existing figure with the following.

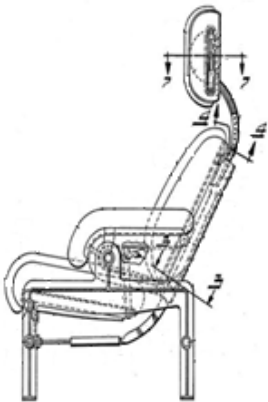

Delete: The caption EP0164267.

DATE: AUGUST 1, 2018

PROJECT RP0019

Replace: The existing figure with the following.



Delete: The caption US6122784.

Replace: The existing figure with the following.

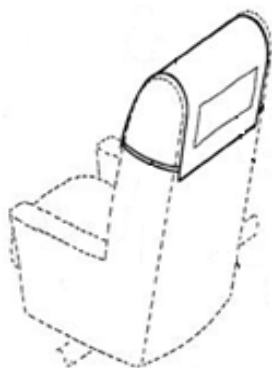

Delete: The caption DE20006038U.

References
Limiting references

Delete: All rows except the first row (shown below) of the Limiting references table.

Chairs having head-rest coupled simultaneously	A47C 1/036
--	----------------------------

DATE: AUGUST 1, 2018

PROJECT RP0019

movable with other movable parts of the chair, e.g. backrest or seat	
--	--

Insert: The following new Application-oriented references section.

Application-oriented references

Examples of places where the subject matter of this place is covered when specially adapted, used for a particular purpose, or incorporated in a larger system:

Head-rests for vehicle seats	B60N 2/80
Head-rests for disabled persons chairs	A61G 5/121
Head rest for operating or dental chairs	A61G 15/125

Insert: The following new reference in the Informative references section.

Informative references

Pillows	A47G 9/10
---------	---------------------------

A47C 7/402

Definition statement

Replace: The existing figure with the following.

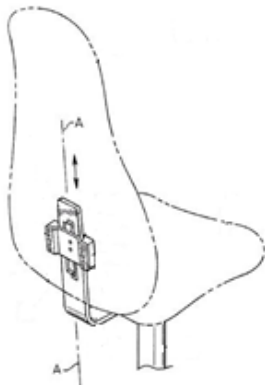

DATE: AUGUST 1, 2018

PROJECT RP0019

Delete: The caption US6540296.

A47C 7/405

Definition statement

Replace: The existing figure with the following.



A47C 7/407

Definition statement

Replace: The existing figure with the following.



Delete: The caption EP1053702.

DATE: AUGUST 1, 2018

PROJECT RP0019

A47C 7/42

Definition statement

Replace: The existing figure with the following.



Delete: The caption US6422654.

Replace: The existing figure with the following.

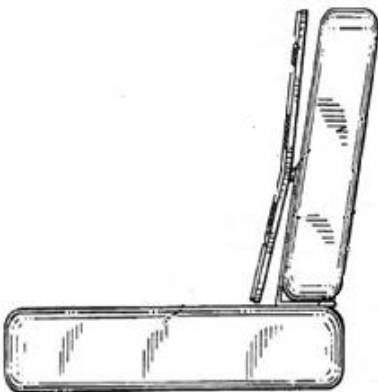

Delete: The caption US6959964.

References

CPC Form – v.5

DATE: AUGUST 1, 2018

PROJECT RP0019

Limiting references

Delete: The entire Limiting references section.

Insert: The following new Application-oriented references section.

Application-oriented references

Examples of places where the subject matter of this place is covered when specially adapted, used for a particular purpose, or incorporated in a larger system:

Backrest for disabled persons chairs	A61G 5/122
--------------------------------------	----------------------------

Informative references

Insert: The following new row in the Informative references table.

Detachable or loose back supports associated with beds	A47C 20/027
--	-----------------------------

A47C 7/44

Definition statement

Replace: The existing figure with the following.

DATE: AUGUST 1, 2018

PROJECT RP0019



Delete: The caption US5902012.

References

Limiting references

Delete: The entire Limiting references section.

Insert: The following new Informative references section.

Informative references

Attention is drawn to the following places, which may be of interest for search:

Chairs having movable-coupled seat and backrest characterised by elastic means	A47C 1/03261
Rocking chairs having elastic frames	A47C 3/021
Rocking chairs with seat, or with seat and back-rest unit, elastically mounted in a rigid frame	A47C 3/025

DATE: AUGUST 1, 2018

PROJECT RP0019

A47C 7/46

Definition statement

Replace: The existing figure with the following.



Delete: The caption GB640336.

Replace: The existing figure with the following.



Delete: The caption US5997094.

DATE: AUGUST 1, 2018

PROJECT RP0019

Replace: The existing figure with the following.



Delete: The caption DE19930922.

References

Limiting references

Delete: The entire Limiting references section.

Insert: The following new Application-oriented references section.

Application-oriented references

Examples of places where the subject matter of this place is covered when specially adapted, used for a particular purpose, or incorporated in a larger system:

Vehicle seat lumbar support	B60N 2/66
-----------------------------	---------------------------

Glossary of terms

Delete: The parentheses and the information within the parentheses in the second column.

Replace: “Beck” with “back” in the second column.

"Akerblom" chair	chair having special backrest profile corresponding to the curvature of the human back
------------------	--

DATE: AUGUST 1, 2018

PROJECT RP0019

A47C 7/48

Definition statement

Replace: The existing figure with the following.



Delete: The caption DE202004016253U.

Replace: The existing figure with the following.

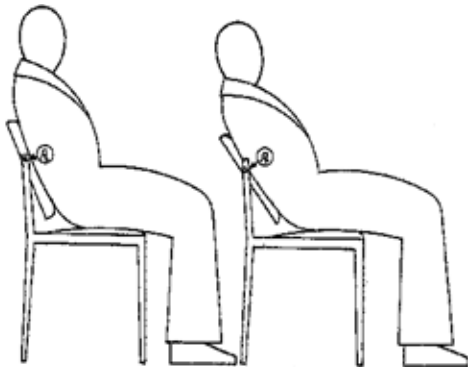

Delete: The caption FR789053.

A47C 7/50

Definition statement

CPC Form – v.5

DATE: AUGUST 1, 2018

PROJECT RP0019

Replace: The existing figure with the following.



Replace: The existing figure with the following.

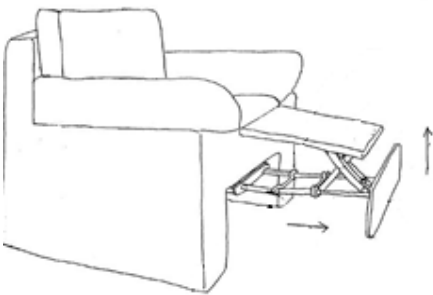

Delete: The caption DE20116145U.

References

Limiting references

Delete: The following four references from the Limiting references table.

Detachable or loose foot or leg supports for beds	A47C 20/021
Leg-rests or foot-rests for disable persons chairs	A61G 5/127 , A61G 5/128
Lower-leg-rests for vehicles, e.g. calf-rests	B60N 2/995
Foot-rests for vehicle seats	B60N 3/06

DATE: AUGUST 1, 2018

PROJECT RP0019

Insert: The following new Application-oriented references section.

Application-oriented references

Examples of places where the subject matter of this place is covered when specially adapted, used for a particular purpose, or incorporated in a larger system:

Leg-rests or foot-rests for disabled persons chairs	A61G 5/127 , A61G 5/128
Lower-leg-rests for vehicles, e.g. calf-rests	B60N 2/995
Foot-rests for vehicle seats	B60N 3/06

Insert: The following new Informative references section.

Informative references

Attention is drawn to the following places, which may be of interest for search:

Detachable or loose foot or leg supports for beds	A47C 20/021
---	-----------------------------

A47C 7/54

Definition statement

Replace: The existing figure with the following.

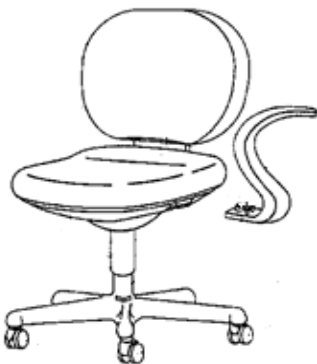

DATE: AUGUST 1, 2018

PROJECT RP0019

Replace: The existing figure with the following.

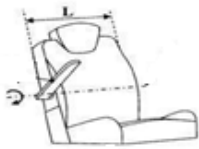

Delete: The caption FR2883526.

References

Delete: The entire Limiting references section.

Insert: The following new Application-oriented references section.

Application-oriented references

Examples of places where the subject matter of this place is covered when specially adapted, used for a particular purpose, or incorporated in a larger system:

Armrest for disabled persons chairs	A61G 5/125
Armrest for vehicles seats	B60N 2/75

Insert: The following new Informative references section.

Informative references

Attention is drawn to the following places, which may be of interest for search:

Chairs with armrest tables	A47C 7/68
Sofas convertible to bed by tilting or extending the armrests	A47C 17/12
Sofa convertible to bed by tilting or pivoting a backrest	A47C 17/18

DATE: AUGUST 1, 2018

PROJECT RP0019

with tilting or pivoting the armrest	
Detachable or loose foot or leg supports for beds	A47C 20/021

A47C 7/56

Definition statement

Replace: The existing figure with the following.



Delete: The caption WO0219869.

Replace: The existing figure with the following.

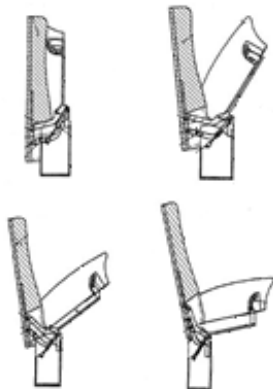

Delete: The caption EP1714582.

DATE: AUGUST 1, 2018

PROJECT RP0019

Replace: The existing figure with the following.

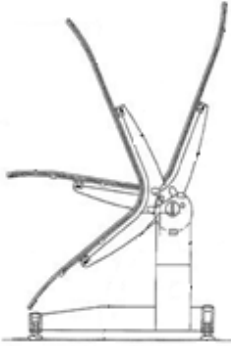

Delete: The caption DE29514742U.

References

Limiting references

Delete: The entire Limiting references section.

Informative references

Insert: The following new row in the existing Informative references table.

Coin-freed apparatus for seats or footstools	G07F 17/08
--	----------------------------

A47C 7/62

Definition statement

Delete: The existing figure and caption.

A47C 7/64

Definition statement

Replace: The existing figure with the following.

DATE: AUGUST 1, 2018

PROJECT RP0019



Delete: The caption WO2006018321.

References

Limiting references

Delete: The entire Limiting references section.

Insert: The following new Application-oriented references section.

Application-oriented references

Examples of places where the subject matter of this place is covered when specially adapted, used for a particular purpose, or incorporated in a larger system:

Hats, clothes or clothes hangers used in vehicles	B60R 7/10
---	---------------------------

Insert: The following new Informative references section.

Informative references

Attention is drawn to the following places, which may be of interest for search:

Domestic hat or coat Holders	A47G 25/00
------------------------------	----------------------------

A47C 7/66

Definition statement

Delete: The figure with the corresponding caption US6899388.

DATE: AUGUST 1, 2018

PROJECT RP0019

Delete: The caption US6899388.

Replace: The existing figure with the following.

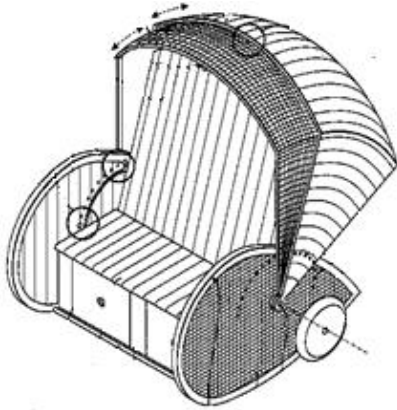

Delete: The caption DE202006019292U.

DATE: AUGUST 1, 2018

PROJECT RP0019

References

Limiting references

Delete: The entire Limiting references section.

Informative references

Insert: The following two new references in the Informative references table.

Liquid impermeable removable or loose chair covers	A47C 31/113
Bathing or beach cabins	E04H 15/003

A47C 7/68

Definition statement

Replace: The existing figure with the following.



Delete: The caption US4861108.

Replace: The existing figure with the following.

DATE: AUGUST 1, 2018

PROJECT RP0019

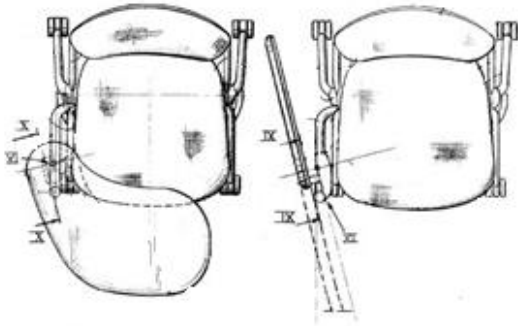

Delete: The caption EP1266596.

References

Limited references

Delete: The entire Limiting references section.

Insert: The following new Application-oriented references section.

Application-oriented references

Examples of places where the subject matter of this place is covered when specially adapted, used for a particular purpose, or incorporated in a larger system:

Children's chairs with trays	A47D 1/008
Tables, working plates, trays for disabled persons chairs	A61G 5/1094
Tables or trays for use in vehicles	B60N 3/001

Informative references

Insert: The following four new references in the Informative references table.

Suspended or hinged panels forming a table	A47B 5/00
Bed tables	A47B 23/00
Adjustable armrests for reclining or easy chairs	A47C 1/03

DATE: AUGUST 1, 2018

PROJECT RP0019

Arm supports for non-reclining and non-easy chairs	A47C 7/54
--	---------------------------

A47C 27/001

Definition statement

Replace: The existing figure with the following.

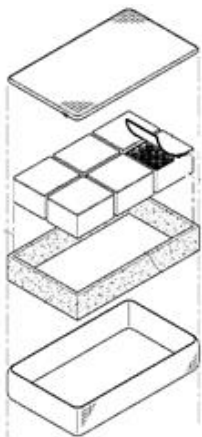

Delete: The caption WO2009048209.

References

Limiting references

Delete: The entire Limiting references section.

Insert: The following new Application-oriented references section.

Application-oriented references

Examples of places where the subject matter of this place is covered when specially adapted, used for a particular purpose, or incorporated in a larger system:

DATE: AUGUST 1, 2018

PROJECT RP0019

Medical beds with arrangements for preventing bed-sores having modules blocks, or inserts, with layer of different material	A61G 7/05715
---	------------------------------

Insert: The following new Informative references section.

Informative references

Attention is drawn to the following places, which may be of interest for search:

Seating furniture convertible to bed with loose or connected by the fabric hinge cushions	A47C 17/045
Foamed mattresses with several layers	A47C 27/15

A47C 27/002

Definition statement

Replace: The existing figure with the following.

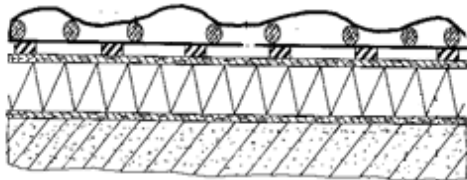

Delete: The caption DE20309794U.

Replace: The existing figure with the following.

DATE: AUGUST 1, 2018

PROJECT RP0019

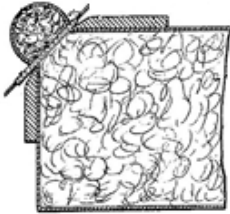

Delete: The caption US1450102.

References

Limiting references

Replace: The existing Limiting references table with the following.

Bed linens, blankets, or Counterpanes	A47G 9/02
---------------------------------------	---------------------------

Insert: The following new Application-oriented references section.

Application-oriented references

Examples of places where the subject matter of this place is covered when specially adapted, used for a particular purpose, or incorporated in a larger system:

Medical beds with dispensers of disposable sheets	A61G 7/0502
---	-----------------------------

Informative references

Insert: The following six new references in the Informative references table.

Beds with sheet holders or bed cover holders	A47C 21/02
Mattress hand straps	A47C 31/08
Loose or removable mattress covers	A47C 31/105
Travelling rugs; Sleeping rugs	A47G 9/06
Sleeping bags	A47G 9/08

DATE: AUGUST 1, 2018

PROJECT RP0019

Devices for preventing wetting or pollution of the bed, e.g. absorbent protective pads	A61F 5/48
--	---------------------------

A47C 27/04

Definition statement

Replace: The existing figure with the following.

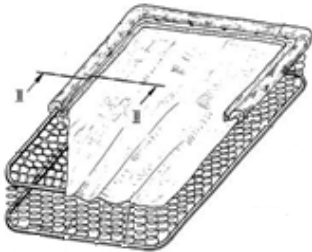

Delete: The caption DE1232712.

Replace: The existing figure with the following.

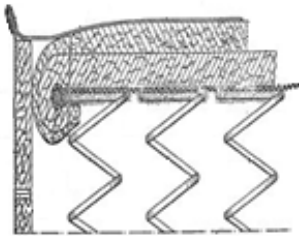

Delete: The caption DE1429452.

Replace: The existing figure with the following.

DATE: AUGUST 1, 2018

PROJECT RP0019

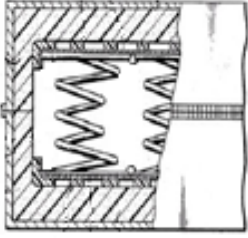

Delete: The caption US4476595.

Replace: The existing figure with the following.

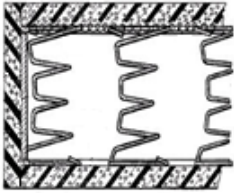

Delete: The caption US3920609.

Replace: The existing figure with the following.



Delete: The caption WO2004039215.

Replace: The existing figure with the following.

DATE: AUGUST 1, 2018

PROJECT RP0019



Delete: The caption GB704611.

References

Limiting references

Delete: All rows of the Limiting references table except the fourth row as shown.

Foamed mattresses with springs moulded in, or situated in cavities or openings in foam materials	A47C 27/20
--	----------------------------

Insert: The following new Informative references section.

Informative references

Attention is drawn to the following places, which may be of interest for search:

Chairs with seat parts having springs in compression, e.g. coil springs	A47C 7/34
Spring mattresses with rigid frame having springs in compression, e.g. coiled springs	A47C 23/04
Spring mattress with rigid frame having combination of nets with springs in compression	A47C 23/32
Upholstery attaching means	A47C 31/02

DATE: AUGUST 1, 2018

PROJECT RP0019

Manufacturing mattresses	B68G 7/00
Springs in general	F16F

A47C 27/081

Definition statement

Replace: The existing figure with the following.

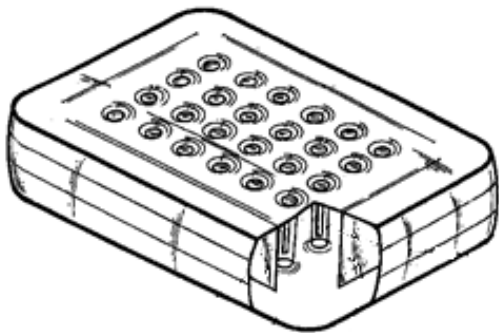

Delete: The caption US7150060.

References

Delete: The entire Limiting references section.

Insert: The following new Application-oriented references section.

Application-oriented references

Examples of places where the subject matter of this place is covered when specially adapted, used for a particular purpose, or incorporated in a larger system:

Medical beds with arrangements for preventing the bed-sores having inflatable chambers	A61G 7/05769
Vehicle seats with hydro-pneumatic adjustments of the shape	B60N 2/914, B60N 2/7082

DATE: AUGUST 1, 2018

PROJECT RP0019

Informative referencesInsert: The following new 11 rows in the Informative references table.

Inflatable chairs	A47C 4/54
Chairs with lumbar support adjustable by fluid means	A47C 7/467
Beds with fluid means adjustable inclination	A47C 20/048
Spring mattresses with rigid frame with inflatable elements	A47C 23/047
Liquid mattresses	A47C 27/085
Fibrous mattresses with inflatable elements	A47C 27/128
Foam mattresses with inflatable bodies	A47C 27/18
Bed covers, counterpanes, travelling rugs or sleeping rugs with inflatable means	A47G 2009/003
Inflatable pillows	A47G 9/1027
Devices for lowering persons from buildings by making use of jumping devices, e.g. jumping-mattresses	A62B 1/22
Tents or canopies with inflatable mattresses	E04H 2015/208

A47C 27/085**Definition statement**Replace: The existing figure with the following.

DATE: AUGUST 1, 2018

PROJECT RP0019

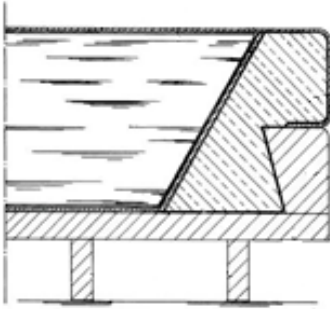

Delete: The caption DE19542135.

References

Limiting references

Delete: The entire Limiting references section.

Insert: The following new Application-oriented references section.

Application-oriented references

Examples of places where the subject matter of this place is covered when specially adapted, used for a particular purpose, or incorporated in a larger system:

Medical beds with arrangements for preventing the bed-sores having fluid like particles, e.g. sand, mud, seeds, gel, beads	A61G 7/05738
--	------------------------------

Informative references

Insert: The following new reference in the Informative references table.

Bed covers, counterpanes, travelling rugs or sleeping rugs with liquid means	A47G 2009/008
--	-------------------------------

DATE: AUGUST 1, 2018

PROJECT RP0019

A47C 27/086

Definition statement

Replace: The existing figure with the following.

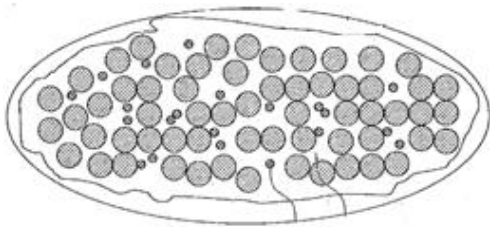

Delete: The caption WO2009029806.

References

Limiting references

Delete: The entire Limiting references section.

Insert: The following new Application-oriented references section.

Application-oriented references

Examples of places where the subject matter of this place is covered when specially adapted, used for a particular purpose, or incorporated in a larger system:

Medical beds with arrangements for preventing the bed-sores having fluid like particles, e.g. sand, mud, seeds, gel, beads	A61G 7/05738
--	------------------------------

DATE: AUGUST 1, 2018

PROJECT RP0019

A47C 27/087

Definition statement

Replace: The existing figure with the following.

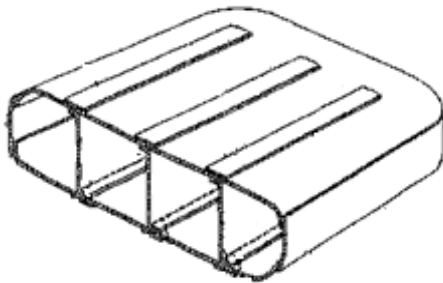

Delete: The caption US818321.

A47C 27/10

Definition statement

Replace: The existing figure with the following.

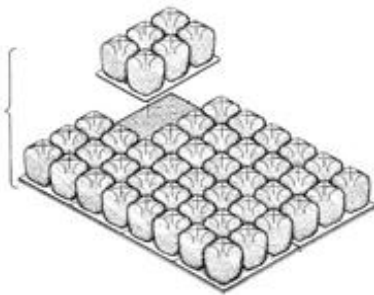

Delete: The caption GB2392088.

References

Limiting references

DATE: AUGUST 1, 2018

PROJECT RP0019

Delete: The entire Limiting references section.

Insert: The following new Application-oriented references section.

Application-oriented references

Examples of places where the subject matter of this place is covered when specially adapted, used for a particular purpose, or incorporated in a larger system:

Medical beds with arrangements for preventing the bed-sores having two groups of alternately inflated chambers	A61G 7/05776
Vehicle seats with hydro-pneumatic adjustments of the shape	B60N 2/914 , B60N 2/7082

A47C 27/12

Definition statement

Replace: The existing figure with the following.

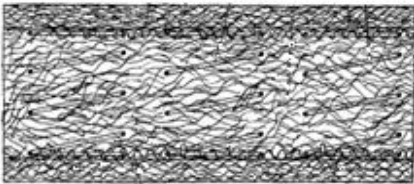

Delete: The caption GB735469.

Replace: The existing figure with the following.

DATE: AUGUST 1, 2018

PROJECT RP0019

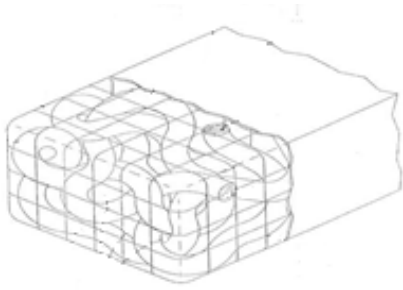

Delete: The caption DE9113467U.

Limiting references

References

Delete: The entire Limiting references section.

Insert: The following new Application-oriented references section.

Application-oriented references

Examples of places where the subject matter of this place is covered when specially adapted, used for a particular purpose, or incorporated in a larger system:

Mattresses for children's beds	A47D 15/001
--------------------------------	-----------------------------

Insert: The following new Informative references section.

Informative references

Attention is drawn to the following places, which may be of interest for search:

Mattresses with both fibrous and foamed inlays	A47C 27/22
Finishing upholstery mainly composed of fibrous material	B68G 11/02

A47C 27/14

Definition statement

Replace: The existing figure with the following.

DATE: AUGUST 1, 2018

PROJECT RP0019

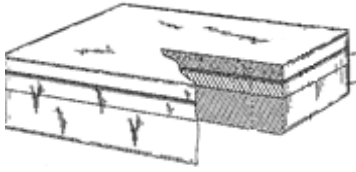

Replace: The existing figure with the following.

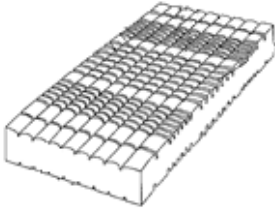

Replace: The existing figure with the following.

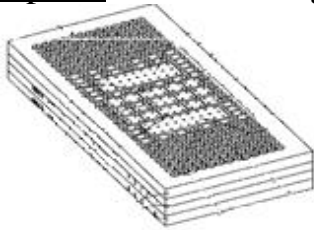

References

Limiting references

Delete: The entire Limiting references section.

Insert: The following new Application-oriented references section.

Application-oriented references

Examples of places where the subject matter of this place is covered when specially adapted, used for a particular purpose, or incorporated in a larger system:

Mattresses for children's beds	A47D 15/001
Medical beds with arrangements for preventing the bed-sores having integral body-	A61G 7/05707

DATE: AUGUST 1, 2018

PROJECT RP0019

bearing projections or protuberances	
Medical beds with arrangements for preventing the bed-sores having modules blocks, or inserts, with layers of different material	A61G 7/05715
Medical beds with arrangements for preventing the bed-sores having cut-outs or depressions in order to relieve the pressure on the parts of the body	A61G 7/05723

Informative references

Insert: The following 10 new references in the Informative references table.

Chairs completely made of foam material	A47C 5/125
Chairs with seats having foamed material including in cushioning part	A47C 7/18
Stuffed mattresses for beds or sofas with spring inlays having foam material in top, bottom or side layers	A47C 27/05
Fluid mattress filled with elastic bodies, e.g. foam	A47C 27/088
Mattresses with both fibrous and foamed inlays	A47C 27/22
Production of upholstery by moulding	B29L 2031/58
Production of mattresses or cushion by moulding	B29L 2031/751

DATE: AUGUST 1, 2018

PROJECT RP0019

Production of seats by moulding	B29L 2031/771
Resilient upholstery pads of cellular material, e.g. sponge rubber	B68G 5/02
Finishing upholstery mainly composed of resilient material, e.g. foam rubber	B68G 11/04

A47C 27/22

Definition statement

Illustrative example of subject matter classified in this group

Replace: The existing figure with the following.

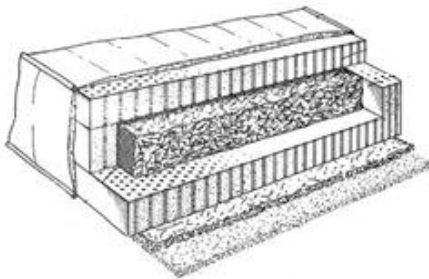

Delete: The caption DE8533414U.

CPC NOTICE OF CHANGES 547

DATE: AUGUST 1, 2018

PROJECT RP0019

2. B. DEFINITIONS QUICK FIX

<u>Symbol</u>	<u>Location of change</u> (e.g., section title)	<u>Existing reference symbol or text</u>	<u>Action; New symbol; New text</u>
A47C			<p>Insert: The following new Special rules of classification section.</p> <p>Special rules of classification References B60N2/00 and B68G are non-limiting in the subclass A47C. CPC will be updated/corrected once this inconsistency is resolved.</p>
A47C 1/00			<p>Insert: The following new Special rules of classification section.</p> <p>Special rules of classification References A47C3/20, A47C13/00, A61G5/00 and A61G15/00 are non-limiting in the main group A47C1/00. CPC will be updated/corrected once this inconsistency is resolved.</p>
A47C 1/00	Limiting references		<p>Delete: The entire Limiting references section.</p>
A47C 1/00			<p>Insert: A new Application-oriented references section with the following 16 references.</p> <p>Application-oriented references <i>Examples of places where the subject matter of this place is covered when specially adapted, used for a particular purpose, or incorporated in a larger system:</i></p> <p>Bath seats A47K 3/12 Shower seats A47K 3/282 Seats for surgeons or dentists A61B 90/60 Chairs for disabled persons A61G 5/00 Operating chairs, dental chairs, physiotherapeutic chairs, gynaecological chairs A61G 15/00</p>

CPC NOTICE OF CHANGES 547

DATE: AUGUST 1, 2018

PROJECT RP0019

<u>Symbol</u>	<u>Location of change</u> (e.g., section title)	<u>Existing reference symbol or text</u>	<u>Action; New symbol; New text</u>
			<p>Exercising apparatus combined with chairs A63B 21/16 Seats specially adapted for vehicles B60N 2/00 Ski-lift seats B61B 12/002 Rail vehicles seats B61D 33/00 Vessel furniture, e.g. boat seats B63B 29/04 Aircraft seats B64D 11/06 Seating furniture for specified purposes not covered by main groups A47C 1/00 or A47C 9/00, A47C 15/004 Seats adapted for angling, e.g. fisherman's seats A01K 97/22 Hunting stands, e.g. hunting seats A01M 31/02 Chairs with toilet means A47K 11/04 Chairs with massage means A61H 2201/0149</p>
A47C 1/028	Limiting references		<p>Delete: The entire Limiting references section.</p>
A47C 1/028			<p>Insert: A new Application-oriented references section with the following reference.</p> <p>Application-oriented references <i>Examples of places where the subject matter of this place is covered when specially adapted, used for a particular purpose, or incorporated in a larger system:</i></p> <p>Children's chairs convertible from high chair to low chair by reversing A47D 1/04</p>
A47C 1/028			<p>Insert: A new Informative references section with the following two references.</p> <p>Informative references <i>Attention is drawn to the following places, which may be of interest for search:</i></p>

CPC NOTICE OF CHANGES 547

DATE: AUGUST 1, 2018

PROJECT RP0019

<u>Symbol</u>	<u>Location of change</u> (e.g., section title)	<u>Existing reference symbol or text</u>	<u>Action; New symbol; New text</u>
			Chair or stool bases for uneven surfaces A47C 7/008 Standing-up or seating -down aids A61G 5/14
A47C 1/034	Limiting references	Supports for the feet or the legs coupled to non-movable parts of the chair A47C 7/50 Stand-alone footrests or leg-rest A47C 16/02 Leg-rests or foot-rests for disable persons chairs A61G 5/127 , A61G 5/128 Lower-leg-rests for vehicles, e.g. calf-rests B60N 2/995 Foot-rests for vehicle seats B60N 3/06	Delete: The following five rows from the Limiting references section. Supports for the feet or the legs coupled to non-movable parts of the chair A47C 7/50 Stand-alone footrests or leg-rest A47C 16/02 Leg-rests or foot-rests for disabled persons chairs A61G 5/127 , A61G 5/128 Lower-leg-rests for vehicles, e.g. calf-rests B60N 2/995 Foot-rests for vehicle seats B60N 3/06
A47C 1/034			Insert: A new Application-oriented references section with the following three references. <i>Application-oriented references</i> <i>Examples of places where the subject matter of this place is covered when specially adapted, used for a particular purpose, or incorporated in a larger system:</i> Lower-leg-rests for vehicles, e.g. calf-rests B60N 2/995 Foot-rests for vehicle seats B60N 3/06 Leg-rests or foot-rests for disabled persons chairs A61G 5/127 , A61G 5/128
A47C 1/034			Insert: A new Informative references section with the following two references. <i>Informative references</i>

CPC NOTICE OF CHANGES 547

DATE: AUGUST 1, 2018

PROJECT RP0019

<u>Symbol</u>	<u>Location of change</u> (e.g., section title)	<u>Existing reference symbol or text</u>	<u>Action; New symbol; New text</u>
			<p><i>Attention is drawn to the following places, which may be of interest for search:</i></p> <p>Supports for the feet or the legs coupled to non-movable parts of the chair A47C 7/50 Stand-alone footrests or leg-rest A47C 16/02</p>
A47C 3/00			<p>Insert: A new Limiting references section with the following two references.</p> <p>Limiting references <i>This place does not cover:</i></p> <p>Chairs adapted for special purposes A41C 1/00 Foldable, collapsible or dismountable chairs A47C 4/00</p>
A47C 3/02			<p>Insert: The following new Special rules of classification section.</p> <p>Special rules of classification Reference A47D13/10 is non-limiting in the subgroup A47C3/02. CPC will be updated/corrected once this inconsistency is resolved.</p>
A47C 3/02	Limiting references		<p>Delete: The entire Limiting references section.</p>
A47C 3/02			<p>Insert: A new Application-oriented references section with the following reference.</p> <p>Application-oriented references <i>Examples of places where the subject matter of this place is covered when specially adapted, used for a particular purpose, or incorporated in a larger system:</i></p> <p>Children's rocking chairs A47D 13/10</p>

CPC NOTICE OF CHANGES 547

DATE: AUGUST 1, 2018

PROJECT RP0019

<u>Symbol</u>	<u>Location of change</u> (e.g., section title)	<u>Existing reference symbol or text</u>	<u>Action; New symbol; New text</u>
A47C 3/02	Informative references		<p>Insert: The following five new table rows in the Informative references section.</p> <p>Chairs having elastically movably-coupled adjustable seat and backrest A47C 1/03261 Chairs with elastically-mounted backrest or backrest-seat-unit in the base frame A47C 7/44 Swings in General A63G 9/00 Rocking horses A63G 15/00 Devices for rocking or oscillating perambulators B62B 9/22</p>
A47C 7/00	Limiting references		<p>Delete: All existing references from the Limiting references table.</p>
A47C 7/00	Limiting references		<p>Insert: The following new reference in the Limiting references table.</p> <p>Attaching to floor A47B 91/08</p>
A47C 7/00			<p>Insert: A new Application-oriented references section with the following 13 references.</p> <p><i>Application-oriented references</i> <i>Examples of places where the subject matter of this place is covered when specially adapted, used for a particular purpose, or incorporated in a larger system:</i></p> <p>Seats adapted for angling, e.g. fisherman's seats A01K 97/22 Hunting stands, e.g. hunting seats A01M 31/02 Bath seats A47K 3/12 Shower seats A47K 3/282 Seats for surgeons or dentists A61B 90/60 Chairs for disabled persons A61G 5/00</p>

CPC NOTICE OF CHANGES 547

DATE: AUGUST 1, 2018

PROJECT RP0019

<u>Symbol</u>	<u>Location of change</u> (e.g., section title)	<u>Existing reference symbol or text</u>	<u>Action; New symbol; New text</u>
			<p>Operating chairs, dental chairs, physiotherapeutic chairs, gynecological chairs A61G 15/00 Exercising apparatus combined with chairs A63B 21/16 Seats specially adapted for vehicles B60N 2/00 Ski-lift seats B61B 12/002 Rail vehicles seats B61D 33/00 Vessel furniture, e.g. boat seats B63B 29/04 Aircraft seats B64D 11/06</p>
A47C 7/00			<p>Insert: A new Informative references section with the following two references.</p> <p>Informative references <i>Attention is drawn to the following places, which may be of interest for search:</i></p> <p>Chairs with toilet means A47K 11/04 Chairs with massage means A61H 2201/0149</p>
A47C 7/02	Limiting references	<p>Chairs having horizontally-adjustable seats A47C 1/023 Seats detachable mounted on the stadium benches A47C 1/16 Legless chairs with seat directly resting on the floor A47C 3/16 Measuring means for adapting chairs to the shape or weight of persons A47C 31/126 Seat cushions specially adapted for wheelchairs A61G 5/1045 Producing upholstery articles, e.g. cushions, seats B29D 99/0092 Production of upholstery by moulding B29L 2031/58 Production of mattresses or cushions by moulding B29L 2031/751</p>	<p>Delete: The following 11 rows from the Limiting references section.</p> <p>Chairs having horizontally-adjustable seats A47C 1/023</p> <p>Seats detachable mounted on the stadium benches A47C 1/16</p> <p>Legless chairs with seat directly resting on the floor A47C 3/16</p> <p>Measuring means for adapting chairs to the shape or weight of persons A47C 31/126</p> <p>Seat cushions specially adapted for wheelchairs A61G 5/1045 Producing upholstery articles, e.g. cushions, seats B29D 99/0092</p>

CPC NOTICE OF CHANGES 547

DATE: AUGUST 1, 2018

PROJECT RP0019

<u>Symbol</u>	<u>Location of change</u> (e.g., section title)	<u>Existing reference symbol or text</u>	<u>Action; New symbol; New text</u>
		Production of seats by moulding B29L 2031/771 Upholstery in general B68G Testing of furniture, e.g. seats or mattresses G01M 99/001	Production of upholstery by moulding B29L 2031/58 Production of mattresses or cushions by moulding B29L 2031/751 Production of seats by moulding B29L 2031/771 Upholstery in general B68G Testing of furniture, e.g. seats or mattresses G01M 99/001
A47C 7/02			<p>Insert: A new Application-oriented references section with the following reference.</p> <p>Application-oriented references <i>Examples of places where the subject matter of this place is covered when specially adapted, used for a particular purpose, or incorporated in a larger system:</i></p> <p>Seat cushions specially adapted for wheelchairs A61G 5/1045</p>
A47C 7/02			<p>Insert: A new Informative references section with the following 10 references.</p> <p>Informative references <i>Attention is drawn to the following places, which may be of interest for search:</i></p> <p>Chairs having horizontally-adjustable seats A47C 1/023</p> <p>Seats detachable mounted on the stadium benches A47C 1/16</p> <p>Legless chairs with seat directly resting on the floor A47C 3/16 Measuring means for adapting chairs to the shape or weight of persons A47C 31/126</p>

CPC NOTICE OF CHANGES 547

DATE: AUGUST 1, 2018

PROJECT RP0019

<u>Symbol</u>	<u>Location of change</u> (e.g., section title)	<u>Existing reference symbol or text</u>	<u>Action; New symbol; New text</u>
			<p>Producing upholstery articles, e.g. cushions, seats B29D 99/0092</p> <p>Production of upholstery by moulding B29L 2031/58</p> <p>Production of mattresses or cushions by moulding B29L 2031/751</p> <p>Production of seats by moulding B29L 2031/771</p> <p>Upholstery in general B68G Testing of furniture, e.g. seats or mattresses G01M 99/001</p>
A47C 7/40	Limiting references		Delete: The entire Limiting references section.
A47C 7/40			<p>Insert: A new Application-oriented references section with the following reference.</p> <p>Application-oriented references <i>Examples of places where the subject matter of this place is covered when specially adapted, used for a particular purpose, or incorporated in a larger system:</i></p> <p>Back cushions specially adapted for wheel chairs A61G 5/1048</p>
A47C 7/40			<p>Insert: A new Informative references section with the following reference.</p> <p>Informative references <i>Attention is drawn to the following places, which may be of interest for search:</i></p> <p>Detachable or loose back supports associated with beds A47C 20/027</p>
A47C 7/72	Limiting references		Delete: The entire Limiting references section.

CPC NOTICE OF CHANGES 547

DATE: AUGUST 1, 2018

PROJECT RP0019

<u>Symbol</u>	<u>Location of change</u> (e.g., section title)	<u>Existing reference symbol or text</u>	<u>Action; New symbol; New text</u>
A47C 7/72			<p>Insert: A new Application-oriented references section with the following three references.</p> <p>Application-oriented references <i>Examples of places where the subject matter of this place is covered when specially adapted, used for a particular purpose, or incorporated in a larger system:</i></p> <p>Heating or cooling appliances for medical or therapeutic treatment of the human body A61F 7/00</p> <p>Heating or ventilating devices for vehicle seats B60N 2/56</p> <p>Accessories for vehicle, e.g. for vehicle seats such as radio sets, television sets, telephones B60R 11/02</p>
A47C 7/72			<p>Insert: A new Informative references section with the following five references.</p> <p>Informative references <i>Attention is drawn to the following places, which may be of interest for search:</i></p> <p>Chairs with lumbar support adjustable by fluid means A47C 7/467</p> <p>Beds with lighting, radio or telephone means A47C 21/003</p> <p>Beds with ventilating, cooling or heating devices A47C 21/04 Pillows with cooling or heating means A47G 9/1036</p>

CPC NOTICE OF CHANGES 547

DATE: AUGUST 1, 2018

PROJECT RP0019

<u>Symbol</u>	<u>Location of change</u> (e.g., section title)	<u>Existing reference symbol or text</u>	<u>Action; New symbol; New text</u>
			Combination of lighting devices with furniture F21V 33/0012
A47C 9/002	Limiting references		Delete: The entire Limiting references section.
A47C 9/002			<p>Insert: A new Informative references section with the following four references.</p> <p>Informative references <i>Attention is drawn to the following places, which may be of interest for search:</i></p> <p>Rocking chairs A47C3/02</p> <p>Chairs' seats especially profiled and adapted to the body contour A47C7/029</p> <p>Chairs' seats of adjustable shape; elastically mounted A47C7/14</p> <p>Exercising apparatus combined with chairs A63B21/16</p>
A47C 27/00	Limiting references		Delete: The entire Limiting references section.
A47C 27/00			<p>Insert: A new Application-oriented references section with the following two references.</p> <p>Application-oriented references <i>Examples of places where the subject matter of this place is covered when specially adapted, used for a particular purpose, or incorporated in a larger system:</i></p> <p>Mattresses for children's beds A47D 15/001</p>

CPC NOTICE OF CHANGES 547

DATE: AUGUST 1, 2018

PROJECT RP0019

<u>Symbol</u>	<u>Location of change</u> (e.g., section title)	<u>Existing reference symbol or text</u>	<u>Action; New symbol; New text</u>
			<p>Medical beds with arrangement for preventing bed-sores or for supporting the patients with burns A61G 7/057</p>
A47C 27/00			<p><u>Insert:</u> A new Informative references section with the following 14 references.</p> <p><i>Informative references</i> <i>Attention is drawn to the following places, which may be of interest for search:</i></p> <p>Chairs with detachable or loose seat cushions A47C 7/021</p> <p>Bedsteads A47C 19/00</p> <p>Mattresses with rigid frame, e.g. spring boxes A47C 23/00</p> <p>Upholstery attaching means A47C 31/02</p> <p>Sacks or packs convertible into beds or mattresses A45F 4/06</p> <p>Show stands for furniture e.g. beds or mattresses A47F 7/30</p> <p>Making wire network, e.g. wire nets for spring mattresses B21F 27/16</p> <p>Production of upholstery by moulding B29L 2031/58 Production of mattresses or cushion by moulding B29L 2031/751</p>

CPC NOTICE OF CHANGES 547

DATE: AUGUST 1, 2018

PROJECT RP0019

<u>Symbol</u>	<u>Location of change</u> (e.g., section title)	<u>Existing reference symbol or text</u>	<u>Action; New symbol; New text</u>
			<p>Resilient upholstery pads in general B68G 5/00</p> <p>Manufacturing mattresses B68G 7/00</p> <p>Machines for sewing quilts or mattresses D05B 11/00</p> <p>Springs in general F16F</p> <p>Testing of furniture, e.g. seats or mattresses G01M 99/001</p>
A47C 27/088	Limiting references		Delete: The entire Limiting references section.
A47C 27/088			<p>Insert: A new Informative references section with the following two references.</p> <p>Informative references <i>Attention is drawn to the following places, which may be of interest for search:</i></p> <p>Fluid-like particles mattresses or cushions, e.g. filled with beads A47C 27/086</p> <p>Foam mattresses with inflatable bodies A47C 27/18</p>

NOTES:

- The table above is used for corrections or modifications to existing definitions, e.g. delete an entire definition or part thereof; propose new wording or modify wording of a section, change the symbol the definition is associated with, change or delete a reference symbol, etc.
- Do not delete (F) symbol definitions.

CPC NOTICE OF CHANGES 547

DATE: AUGUST 1, 2018

PROJECT RP0019

3. REVISION CONCORDANCE LIST (RCL)

Type*	From CPC Symbol (existing)	To CPC Symbol(s)
C	A47C 1/03	A47C 1/03, A47C 1/0303, A47C 1/0305 A47C 1/0307, A47C 1/0308 A47C 7/541
C	A47C 1/03261	A47C 1/03261, A47C 1/03277, A47C 1/03279
C	A47C 1/03266	A47C 1/03266, A47C 1/03277, A47C 1/03279
C	A47C 1/03272	A47C 1/03272, A47C 1/03274
C	A47C 1/03277	A47C 1/03277, A47C 1/03279
C	A47C 3/025	A47C 3/025, A47C 3/0251
C	A47C 3/0252	A47C 3/0251, A47C 3/0252
C	A47C 3/0255	A47C 3/0251, A47C 3/0255
C	A47C 3/0257	A47C 3/0251, A47C 3/0257
C	A47C 3/026	A47C 3/0251, A47C 3/026
C	A47C 3/027	A47C 3/0251, A47C 3/027
C	A47C 7/021	A47C 7/021, A47C 7/0213
D	A47C 7/022	<administrative transfer to A47C 7/029>
C	A47C 7/14	A47C 7/14, A47C 7/142 A47C 7/144, A47C 7/44, A47C7/441, A47C 7/443, A47C 7/444, A47C 7/445, A47C 7/4454, A47C 7/446, A47C 7/448, A47C 1/03261, A47C 1/03266, A47C 1/03272, A47C 1/03274, A47C 1/03277, A47C 1/03279, A47C 1/03283, A47C 1/03288
C	A47C 7/44	A47C 7/44, A47C 7/444, A47C 7/445, A47C 7/4454
C	A47C 7/443	A47C 7/443, A47C 7/444
C	A47C 7/445	A47C 7/445, A47C 7/4454
C	A47C 7/506	A47C 7/506, A47C 7/5062, A47C 7/5064, A47C 7/5066, A47C 7/5068
C	A47C 7/54	A47C 7/54, A47C 7/541, A47C 1/03, A47C 1/0303, A47C 1/0305, A47C 1/0307, A47C 1/0308

CPC NOTICE OF CHANGES 547

DATE: AUGUST 1, 2018

PROJECT RP0019

<u>Type*</u>	<u>From CPC Symbol (existing)</u>	<u>To CPC Symbol(s)</u>
C	A47C 7/543	A47C 7/543, A47C 7/541, A47C 1/03, A47C 1/0303, A47C 1/0305, A47C 1/0307, A47C 1/0308
C	A47C 7/546	A47C 7/546, A47C 7/541, A47C 1/03, A47C 1/0303, A47C 1/0305, A47C 1/0307, A47C 1/0308
C	A47C 7/62	A47C 7/62, A47C 7/622, A47C 7/624, A47C 7/626, A47C 7/628
C	A47C 7/66	A47C 7/66, A47C 7/664, A47C 7/666
C	A47C 7/68	A47C 7/68, A47C 7/622, A47C 7/624, A47C 7/626, A47C 7/628
C	A47C 7/70	A47C 7/70, A47C 7/705, A47C 7/622, A47C 7/624, A47C 7/626, A47C 7/628
C	A47C 7/72	A47C 7/72, A47C 7/723, A47C 7/727

* C = entries with modified file scope where reclassification of documents from the entries is involved; Q = new entries which are firstly populated with documents via administrative transfers from deleted (D) entries. Afterwards, the transferred documents into the Q entry will either stay or be moved to more appropriate entries, as determined by intellectual reclassification; D = deleted entries.

NOTES:

- Only C, D, and Q type entries are included in the table above.
- When multiple symbols are included in the “To” column, avoid using ranges of symbols in order to be as precise as possible.
- For administrative transfer of documents, the following text should be used: “< administrative transfer to XX>” or “<administrative transfer to XX and YY simultaneously>” when administrative transfer of the same documents is to more than one place.
- Administrative transfer to main trunk groups is assumed to be “invention information”, unless otherwise indicated, and to 2000 series groups is assumed to be “additional information”.

CPC NOTICE OF CHANGES 547

DATE: AUGUST 1, 2018

PROJECT RP0019

4. CHANGES TO THE CPC-TO-IPC CONCORDANCE LIST (CICL)

<u>CPC</u>	<u>IPC</u>	<u>Action*</u>
A47C 1/0303	A47C 1/03	new
A47C 1/0305	A47C 1/03	new
A47C 1/0307	A47C 1/03	new
A47C 1/0308	A47C 1/03	new
A47C 1/03274	A47C 1/032	new
A47C 1/03279	A47C 1/032	new
A47C 3/0251	A47C 3/025	new
A47C 7/0213	A47C 7/02	new
A47C 7/022		delete
A47C 7/029	A47C 7/02	new
A47C 7/142	A47C 7/14	new
A47C 7/144	A47C 7/14	new
A47C 7/444	A47C 7/44	new
A47C 7/4454	A47C 7/44	new
A47C 7/5062	A47C 7/50	new
A47C 7/5064	A47C 7/50	new
A47C 7/5066	A47C 7/50	new
A47C 7/5068	A47C 7/50	new
A47C 7/541	A47C 7/54	new
A47C 7/622	A47C 7/62	new
A47C 7/624	A47C 7/62	new
A47C 7/626	A47C 7/62	new
A47C 7/628	A47C 7/62	new
A47C 7/664	A47C 7/66	new
A47C 7/666	A47C 7/66	new
A47C 7/705	A47C 7/70	new
A47C 7/723	A47C 7/72	new
A47C 7/727	A47C 7/72	new

*Action column:

- For an (N) or (Q) entry, provide an IPC symbol and complete the Action column with “NEW.”
- For an existing CPC main trunk entry or indexing entry where the existing IPC symbol needs to be changed, provide an updated IPC symbol and complete the Action column with “UPDATED.”
- For a (D) CPC entry or indexing entry complete the Action column with “DELETE.” IPC symbol does not need to be included in the IPC column.
- For an (N) 2000 series CPC entry which is positioned within the main trunk scheme (breakdown code) provide an IPC symbol and complete the action column with “NEW”.
- For an (N) 2000 series CPC entry positioned at the end of the CPC scheme (orthogonal code), with no IPC equivalent, complete the IPC column with “CPCONLY” and complete the action column with “NEW”.

NOTES:

- F symbols are not included in the CICL table above.
- E and M symbols are not included in the CICL table above unless a change to the existing IPC is desired.

CPC NOTICE OF CHANGES 547

DATE: AUGUST 1, 2018

PROJECT RP0019

5. CROSS-REFERENCE LIST (CRL)

Definitions references impacted by this revision project

<u>Location of reference to be changed</u>	<u>Referenced subclass or group to be changed</u>	<u>Section of definition</u>	<u>Action; New reference symbol; New text</u>
A45B11/00	Means to protect against weather A47C7/66	Informative References	Chairs with means to protect against weather A47C7/664
B64D11/0644	Chairs with arm rest A47C7/506	Informative References	Chairs with adjustable arm rest A47C1/03, A47C7/541
B64D11/0646	Chairs with arm rest A47C7/506	Informative References	Chairs with stationary arm rests A47C7/54

NOTES:

- The CRL tables above are used for changes to locations **outside** of the project scope. Changes to references in scheme titles or definitions **inside** the project scope will be reflected in the “scheme change” template or one of the “definition” templates.
- In addition to other changes proposed in the tables above, in the column titled “Referenced subclass or group to be changed,” **referenced** D symbols should indicate an action of “delete” or should indicate a replacement symbol and **referenced** F symbols should indicate a replacement symbol.
- When a reference is deleted, text related to that reference will also be deleted unless other references or a range of references associated with the same text remain.