

EUROPEAN PATENT OFFICE  
U.S. PATENT AND TRADEMARK OFFICE

CPC NOTICE OF CHANGES 1252

DATE: FEBRUARY 1, 2022

PROJECT RP0258

The following classification changes will be effected by this Notice of Changes:

<u>Action</u>	<u>Subclass</u>	<u>Group(s)</u>
<b>SCHEME:</b>		
Symbols New:	A01K	73/063, 73/067
	A01K	75/005
	A01K	77/005
	A01K	80/005
	A01K	83/025, 83/045, 83/061, 83/063, 83/064, 83/066, 83/067, 83/069
	A01K	85/011, 85/012, 85/013, 85/015, 85/017, 85/018, 85/019, 85/021, 85/022, 85/023, 85/024, 85/025, 85/026, 85/027, 85/028, 85/029, 85/122, 85/125, 85/128, 85/143, 85/147, 85/1803, 85/1807, 85/1811, 85/1813, 85/1817, 85/1821, 85/1823, 85/1827, 85/1831, 85/1833, 85/1837, 85/1841, 85/1843, 85/1847, 85/1851, 85/1853, 85/1857, 85/1861, 85/1863, 85/1867, 85/1871, 85/1873, 85/1877, 85/1881, 85/1883, 85/1887, 85/1891, 85/1893, 85/1897
	A01K	87/008, 87/009
Titles Changed:	A01K	73/06
	A01K	75/00
	A01K	77/00
	A01K	79/02
	A01K	83/00, 83/06
	A01K	85/00
	A01K	87/00
	A01K	97/00
	A01K	97/06
Warnings New:	A01K	73/02, 73/025, 73/04, 73/045, 73/05, 73/053, 73/06, 73/063, 73/067, 73/10
	A01K	75/00, 75/005
	A01K	77/00, 77/005
	A01K	79/02
	A01K	80/00, 80/005
	A01K	83/00, 83/02, 83/025, 83/04, 83/045, 83/06, 83/061, 83/063, 83/064, 83/066

CPC NOTICE OF CHANGES 1252

DATE: FEBRUARY 1, 2022

PROJECT RP0258

<u>Action</u>	<u>Subclass</u>	<u>Group(s)</u>
	A01K	85/00, 85/005, 85/01, 85/011, 85/015, 85/017, 85/018, 85/019, 85/02, 85/021, 85/022, 85/026, 85/029, 85/08, 85/10, 85/12, 85/122, 85/125, 85/14, 85/143, 85/147, 85/16, 85/18, 85/1803, 85/1807, 85/1811, 85/1831, 85/1837, 85/1841, 85/1847, 85/1851, 85/1853, 85/1857, 85/1861, 85/1863, 85/1867, 85/1871, 85/1893, 85/1897
	A01K	87/00, 87/002, 87/005, 87/008, 87/009, 87/02, 87/025, 87/04, 87/06, 87/08, 87/085
	A01K	97/06
Guidance Headings Modified:	A01K	1/00
	A01K	47/00
	A01K	69/00
<b>DEFINITIONS:</b>		
Definitions New:	A01K	73/063, 73/067
	A01K	75/005
	A01K	77/005
	A01K	80/005
	A01K	83/025, 83/045, 83/061, 83/063, 83/064, 83/066, 83/067, 83/069
	A01K	85/011, 85/012, 85/013, 85/015, 85/017, 85/018, 85/019, 85/021, 85/022, 85/023, 85/024, 85/025, 85/026, 85/027, 85/028, 85/029, 85/122, 85/125, 85/128, 85/143, 85/147, 85/1803, 85/1807, 85/1811, 85/1813, 85/1817, 85/1821, 85/1823, 85/1827, 85/1831, 85/1833, 85/1837, 85/1841, 85/1843, 85/1847, 85/1851, 85/1853, 85/1857, 85/1861, 85/1863, 85/1867, 85/1871, 85/1873, 85/1877, 85/1881, 85/1883, 85/1887, 85/1891, 85/1893, 85/1897
	A01K	87/009
Definitions Modified:	A01K	73/02, 73/025, 73/04, 73/045, 73/05, 73/053, 73/06, 73/10
	A01K	75/00, 75/06
	A01K	77/00
	A01K	79/02
	A01K	80/00
	A01K	83/00, 83/02, 83/04, 83/06
	A01K	85/00, 85/005, 85/01, 85/02, 85/08, 85/10, 85/12, 85/14, 85/18
	A01K	87/00, 87/005, 87/025, 87/08, 87/085
	A01K	89/0102

CPC NOTICE OF CHANGES 1252

DATE: FEBRUARY 1, 2022

PROJECT RP0258

<u>Action</u>	<u>Subclass</u>	<u>Group(s)</u>
	A01K	91/10
	A01K	97/00, 97/01, 97/02, 97/045, 97/06

**No other subclasses/groups are impacted by this Notice of Changes.**

**This Notice of Changes includes the following [Check the ones included]:**

1. CLASSIFICATION SCHEME CHANGES

- A. New, Modified or Deleted Group(s)
- B. New, Modified or Deleted Warning(s)
- C. New, Modified or Deleted Note(s)
- D. New, Modified or Deleted Guidance Heading(s)

2. DEFINITIONS

- A. New or Modified Definitions (Full definition template)
- B. Modified or Deleted Definitions (Definitions Quick Fix)

3.  REVISION CONCORDANCE LIST (RCL)

4.  CHANGES TO THE CPC-TO-IPC CONCORDANCE LIST (CICL)

5.  CHANGES TO THE CROSS-REFERENCE LIST (CRL)

CPC NOTICE OF CHANGES 1252

DATE: FEBRUARY 1, 2022

PROJECT RP0258

1. CLASSIFICATION SCHEME CHANGES

A. New, Modified or Deleted Group(s)

**SUBCLASS A01K – ANIMAL HUSBANDRY; CARE OF BIRDS, FISHES, INSECTS; FISHING; REARING OR BREEDING ANIMALS, NOT OTHERWISE PROVIDED FOR; NEW BREEDS OF ANIMALS**

<u>Type*</u>	<u>Symbol</u>	<u>Indent Level Number of dots (e.g. 0, 1, 2)</u>	<u>Title</u> “CPC only” text should normally be enclosed in {curly brackets}**	<u>Transferred to#</u>
C	A01K 73/02	1	Trawling nets	A01K 73/02, A01K 73/063, A01K 73/067
C	A01K 73/025	2	{Regulation of net depth }	A01K 73/025, A01K 73/063, A01K 73/067
C	A01K 73/04	2	Devices for spreading or positioning, e.g. control thereof	A01K 73/04, A01K 73/063, A01K 73/067
C	A01K 73/045	3	for lateral sheering, e.g. trawl boards	A01K 73/045, A01K 73/063, A01K 73/067
C	A01K 73/05	3	for vertical sheering	A01K 73/05, A01K 73/063, A01K 73/067
C	A01K 73/053	3	Ground-line rollers	A01K 73/053, A01K 73/063, A01K 73/067
C	A01K 73/06	2	Hauling devices for the headlines	A01K 73/06, A01K 73/063, A01K 73/067
N	A01K 73/063	2	{having excluder device }	
N	A01K 73/067	2	{using electrical shock to control fish or aquatic animal }	
C	A01K 73/10	2	Determining the quantity of the catch, e.g. by the pull or drag on the lines	A01K 73/10, A01K 73/063, A01K 73/067
C	A01K 75/00	0	Accessories for fishing nets; Details of fishing nets, e.g. structure	A01K 75/00, A01K 75/005
N	A01K 75/005	1	{Net structures, e.g. structural arrangements of net panels }	
C	A01K 77/00	0	Landing-nets for fishing; Landing-spoons for fishing	A01K 77/00, A01K 77/005
N	A01K 77/005	1	{foldable }	
C	A01K 79/02	1	by electrocution	A01K 79/02, A01K 73/067
C	A01K 80/00	0	Harvesting oysters, mussels, sponges or the like	A01K 80/00, A01K 80/005
N	A01K 80/005	1	{Sleds running on the bottom for catching ground-living or underground-living aquatic organisms }	
C	A01K 83/00	0	Fish-hooks	A01K 83/00, A01K 83/066, A01K 83/067, A01K 83/069
C	A01K 83/02	1	Expanding fish-hook assembly	A01K 83/02, A01K 83/025

CPC NOTICE OF CHANGES 1252

DATE: FEBRUARY 1, 2022

PROJECT RP0258

<u>Type*</u>	<u>Symbol</u>	<u>Indent Level Number of dots (e.g. 0, 1, 2)</u>	<u>Title</u> <u>“CPC only” text should normally be enclosed in {curly brackets}**</u>	<u>Transferred to#</u>
N	A01K 83/025	2	{pull-actuated}	
C	A01K 83/04	1	with special gripping arms	A01K 83/04, A01K 83/045
N	A01K 83/045	2	{pull-actuated}	
C	A01K 83/06	1	Devices for holding bait on hooks	A01K 83/06, A01K 83/061, A01K 83/063, A01K 83/064
N	A01K 83/061	2	{bait encircling }	
N	A01K 83/063	2	{with opposed gripping jaws }	
N	A01K 83/064	2	{mounted on, integral with, or rigidly connected to the hook }	
N	A01K 83/066	1	{Guards, e.g. weedless hooks }	
N	A01K 83/067	2	{shiftable, collapsible, or line-operated }	
N	A01K 83/069	2	{Hook closing }	
C	A01K 85/00	0	Artificial bait for fishing	A01K 85/00, A01K 85/011, A01K 85/012, A01K 85/013, A01K 85/019, A01K 85/026, A01K 85/027, A01K 85/028, A01K 85/029, A01K 85/1803, A01K 85/1807, A01K 85/1811, A01K 85/1813, A01K 85/1817, A01K 85/1821, A01K 85/1823, A01K 85/1827, A01K 85/1831, A01K 85/1833, A01K 85/1837, A01K 85/1841, A01K 85/1843, A01K 85/1847, A01K 85/1851, A01K 85/1853, A01K 85/1857, A01K 85/1861, A01K 85/1863, A01K 85/1867, A01K 85/1871, A01K 85/1873, A01K 85/1877, A01K 85/1881, A01K 85/1883, A01K 85/1887, A01K 85/1891, A01K 85/1893, A01K 85/1897
C	A01K 85/005	1	{without hooks }	A01K 85/005, A01K 85/011, A01K 85/012, A01K 85/013, A01K 85/019, A01K 85/026, A01K 85/027, A01K

CPC NOTICE OF CHANGES 1252

DATE: FEBRUARY 1, 2022

PROJECT RP0258

<u>Type*</u>	<u>Symbol</u>	<u>Indent Level Number of dots (e.g. 0, 1, 2)</u>	<u>Title</u> <u>“CPC only” text should normally be enclosed in {curly brackets}**</u>	<u>Transferred to#</u>
				85/028, A01K 85/029, A01K 85/1803, A01K 85/1807, A01K 85/1811, A01K 85/1813, A01K 85/1817, A01K 85/1821, A01K 85/1823, A01K 85/1827, A01K 85/1831, A01K 85/1833, A01K 85/1837, A01K 85/1841, A01K 85/1843, A01K 85/1847, A01K 85/1851, A01K 85/1853, A01K 85/1857, A01K 85/1861, A01K 85/1863, A01K 85/1867, A01K 85/1871, A01K 85/1873, A01K 85/1877, A01K 85/1881, A01K 85/1883, A01K 85/1887, A01K 85/1891, A01K 85/1893, A01K 85/1897
C	A01K 85/01	1	with light emission, sound emission, scent dispersal or the like	A01K 85/01, A01K 85/011, A01K 85/012, A01K 85/013, A01K 85/015, A01K 85/017, A01K 85/018, A01K 85/019, A01K 85/026, A01K 85/027, A01K 85/028, A01K 85/029, A01K 85/1803, A01K 85/1807, A01K 85/1811, A01K 85/1813, A01K 85/1817, A01K 85/1821, A01K 85/1823, A01K 85/1827, A01K 85/1831, A01K 85/1833, A01K 85/1837, A01K 85/1841, A01K 85/1843, A01K 85/1847, A01K 85/1851, A01K 85/1853, A01K 85/1857, A01K 85/1861, A01K 85/1863, A01K 85/1867, A01K 85/1871, A01K 85/1873, A01K 85/1877, A01K 85/1881, A01K 85/1883, A01K 85/1887, A01K 85/1891, A01K 85/1893, A01K 85/1897
N	A01K 85/011	2	{with ornaments creating visual effects, e.g. colors, patterns}	

CPC NOTICE OF CHANGES 1252

DATE: FEBRUARY 1, 2022

PROJECT RP0258

<u>Type*</u>	<u>Symbol</u>	<u>Indent Level Number of dots (e.g. 0, 1, 2)</u>	<u>Title</u> <u>“CPC only” text should normally be enclosed in {curly brackets}**</u>	<u>Transferred to#</u>
N	A01K 85/012	3	{transparent; including reflectors or patterns}	
N	A01K 85/013	3	{with projections for simulation and reflecting; with indentations for simulation and reflecting}	
N	A01K 85/015	2	{with light emission}	
N	A01K 85/017	2	{with sound emission}	
N	A01K 85/018	2	{with scent dispersal}	
N	A01K 85/019	2	{with water passage}	
C	A01K 85/02	1	with means for concealing or protecting hooks, e.g. to prevent entanglement with weeds	A01K 85/02, A01K 85/021, A01K 85/022, A01K 85/023, A01K 85/024, A01K 85/025, A01K 85/011, A01K 85/012, A01K 85/013, A01K 85/019, A01K 85/026, A01K 85/027, A01K 85/028, A01K 85/029, A01K 85/1803, A01K 85/1807, A01K 85/1811, A01K 85/1813, A01K 85/1817, A01K 85/1821, A01K 85/1823, A01K 85/1827, A01K 85/1831, A01K 85/1833, A01K 85/1837, A01K 85/1841, A01K 85/1843, A01K 85/1847, A01K 85/1851, A01K 85/1853, A01K 85/1857, A01K 85/1861, A01K 85/1863, A01K 85/1867, A01K 85/1871, A01K 85/1873, A01K 85/1877, A01K 85/1881, A01K 85/1883, A01K 85/1887, A01K 85/1891, A01K 85/1893, A01K 85/1897
N	A01K 85/021	2	{flexible bodies housing or guarding hooks}	
N	A01K 85/022	2	{with guards}	
N	A01K 85/023	3	{Hooks housed within lure body or guarded by lure body}	
N	A01K 85/024	3	{projecting out from the lure body}	

CPC NOTICE OF CHANGES 1252

DATE: FEBRUARY 1, 2022

PROJECT RP0258

<u>Type*</u>	<u>Symbol</u>	<u>Indent Level Number of dots (e.g. 0, 1, 2)</u>	<u>Title</u> <u>“CPC only” text should normally be enclosed in { curly brackets }**</u>	<u>Transferred to#</u>
N	A01K 85/025	3	{Hook point closing or covering}	
N	A01K 85/026	1	{with trap hooks }	
N	A01K 85/027	2	{expanding }	
N	A01K 85/028	2	{pull-actuated}	
N	A01K 85/029	1	{Interchangeable body parts }	
C	A01K 85/08	1	Artificial flies	A01K 85/08, A01K 85/011, A01K 85/012, A01K 85/013, A01K 85/019, A01K 85/026, A01K 85/027, A01K 85/028, A01K 85/029, A01K 85/1803, A01K 85/1807, A01K 85/1811, A01K 85/1813, A01K 85/1817, A01K 85/1821, A01K 85/1823, A01K 85/1827, A01K 85/1831, A01K 85/1833, A01K 85/1837, A01K 85/1841, A01K 85/1843, A01K 85/1847, A01K 85/1851, A01K 85/1853, A01K 85/1857, A01K 85/1861, A01K 85/1863, A01K 85/1867, A01K 85/1871, A01K 85/1873, A01K 85/1877, A01K 85/1881, A01K 85/1883, A01K 85/1887, A01K 85/1891, A01K 85/1893, A01K 85/1897
C	A01K 85/10	1	with at least one flat rotating body having its axis of rotation substantially non-coincident with the longitudinal axis of the body {, e.g. spinners }	A01K 85/10, A01K 85/011, A01K 85/012, A01K 85/013, A01K 85/019, A01K 85/026, A01K 85/027, A01K 85/028, A01K 85/029, A01K 85/1803, A01K 85/1807, A01K 85/1811, A01K 85/1813, A01K 85/1817, A01K 85/1821, A01K 85/1823, A01K 85/1827, A01K 85/1831, A01K 85/1833, A01K 85/1837, A01K 85/1841, A01K 85/1843, A01K 85/1847,



CPC NOTICE OF CHANGES 1252

DATE: FEBRUARY 1, 2022

PROJECT RP0258

<u>Type*</u>	<u>Symbol</u>	<u>Indent Level Number of dots (e.g. 0, 1, 2)</u>	<u>Title</u> <u>“CPC only” text should normally be enclosed in { curly brackets }**</u>	<u>Transferred to#</u>
				A01K 85/1851, A01K 85/1853, A01K 85/1857, A01K 85/1861, A01K 85/1863, A01K 85/1867, A01K 85/1871, A01K 85/1873, A01K 85/1877, A01K 85/1881, A01K 85/1883, A01K 85/1887, A01K 85/1891, A01K 85/1893, A01K 85/1897
C	A01K 85/12	1	comprising a body rotating around its longitudinal axis, e.g. devons	A01K 85/12, A01K 85/122, A01K 85/125, A01K 85/128 A01K 85/011, A01K 85/012, A01K 85/013, A01K 85/019, A01K 85/026, A01K 85/027, A01K 85/028, A01K 85/029, A01K 85/1803, A01K 85/1807, A01K 85/1811, A01K 85/1813, A01K 85/1817, A01K 85/1821, A01K 85/1823, A01K 85/1827, A01K 85/1831, A01K 85/1833, A01K 85/1837, A01K 85/1841, A01K 85/1843, A01K 85/1847, A01K 85/1851, A01K 85/1853, A01K 85/1857, A01K 85/1861, A01K 85/1863, A01K 85/1867, A01K 85/1871, A01K 85/1873, A01K 85/1877, A01K 85/1881, A01K 85/1883, A01K 85/1887, A01K 85/1891, A01K 85/1893, A01K 85/1897
N	A01K 85/122	2	{ the body being of the vane type with a cross-section forming an area rather than a line when viewed perpendicularly to the axis of rotation }	
N	A01K 85/125	2	{ the body being of the vane type with a cross-section forming a line rather than an area when viewed perpendicularly to the axis of rotation }	
N	A01K 85/128	3	{ with spiral or oppositely directed vanes }	
C	A01K 85/14	1	with flat, or substantially flat, undulating bodies, e.g. spoons	A01K 85/14, A01K 85/143, A01K 85/147, A01K 85/011,

CPC NOTICE OF CHANGES 1252

DATE: FEBRUARY 1, 2022

PROJECT RP0258

<u>Type*</u>	<u>Symbol</u>	<u>Indent Level Number of dots (e.g. 0, 1, 2)</u>	<u>Title</u> <u>“CPC only” text should normally be enclosed in {curly brackets}**</u>	<u>Transferred to#</u>
				A01K 85/012, A01K 85/013, A01K 85/019, A01K 85/026, A01K 85/027, A01K 85/028, A01K 85/029, A01K 85/1803, A01K 85/1807, A01K 85/1811, A01K 85/1813, A01K 85/1817, A01K 85/1821, A01K 85/1823, A01K 85/1827, A01K 85/1831, A01K 85/1833, A01K 85/1837, A01K 85/1841, A01K 85/1843, A01K 85/1847, A01K 85/1851, A01K 85/1853, A01K 85/1857, A01K 85/1861, A01K 85/1863, A01K 85/1867, A01K 85/1871, A01K 85/1873, A01K 85/1877, A01K 85/1881, A01K 85/1883, A01K 85/1887, A01K 85/1891, A01K 85/1893, A01K 85/1897
N	A01K 85/143	2	{with spiral or oppositely directed vanes that are non rotatable with respect to the lure body }	
N	A01K 85/147	2	{non-marginal hook attachments; non-pivoted hook attachments }	
C	A01K 85/16	1	with other than flat, or substantially flat, undulating bodies, e.g. plugs	A01K 85/16, A01K 85/011, A01K 85/012, A01K 85/013, A01K 85/019, A01K 85/026, A01K 85/027, A01K 85/028, A01K 85/029, A01K 85/1803, A01K 85/1807, A01K 85/1811, A01K 85/1813, A01K 85/1817, A01K 85/1821, A01K 85/1823, A01K 85/1827, A01K 85/1831, A01K 85/1833, A01K 85/1837, A01K 85/1841, A01K 85/1843, A01K 85/1847, A01K 85/1851, A01K 85/1853, A01K 85/1857, A01K 85/1861, A01K 85/1863, A01K 85/1867, A01K 85/1871, A01K 85/1873, A01K 85/1877,

CPC NOTICE OF CHANGES 1252

DATE: FEBRUARY 1, 2022

PROJECT RP0258

<u>Type*</u>	<u>Symbol</u>	<u>Indent Level Number of dots (e.g. 0, 1, 2)</u>	<u>Title</u> <u>“CPC only” text should normally be enclosed in { curly brackets }**</u>	<u>Transferred to#</u>
				A01K 85/1881, A01K 85/1883, A01K 85/1887, A01K 85/1891, A01K 85/1893, A01K 85/1897
C	A01K 85/18	2	in two or more pieces	A01K 85/18, A01K 85/011, A01K 85/012, A01K 85/013, A01K 85/019, A01K 85/026, A01K 85/027, A01K 85/028, A01K 85/029, A01K 85/1803, A01K 85/1807, A01K 85/1811, A01K 85/1813, A01K 85/1817, A01K 85/1821, A01K 85/1823, A01K 85/1827, A01K 85/1831, A01K 85/1833, A01K 85/1837, A01K 85/1841, A01K 85/1843, A01K 85/1847, A01K 85/1851, A01K 85/1853, A01K 85/1857, A01K 85/1861, A01K 85/1863, A01K 85/1867, A01K 85/1871, A01K 85/1873, A01K 85/1877, A01K 85/1881, A01K 85/1883, A01K 85/1887, A01K 85/1891, A01K 85/1893, A01K 85/1897
N	A01K 85/1803	1	{with a diving vane or lip }	
N	A01K 85/1807	1	{with an automatically movable directing vane }	
N	A01K 85/1811	1	{flexible or with flexible appendages, e.g., worms }	
N	A01K 85/1813	2	{Bodies with plural side-attached flexible appendages }	
N	A01K 85/1817	3	{for simulating wings }	
N	A01K 85/1821	2	{Bodies with trailing flexible appendages }	
N	A01K 85/1823	3	{detachable }	
N	A01K 85/1827	3	{Two rearwardly directed appendages, e.g. for simulating frogs }	
N	A01K 85/1831	1	{mounted on hooks }	
N	A01K 85/1833	2	{Jig head lures }	

CPC NOTICE OF CHANGES 1252

DATE: FEBRUARY 1, 2022

PROJECT RP0258

<b>Type*</b>	<b>Symbol</b>	<b>Indent Level Number of dots (e.g. 0, 1, 2)</b>	<b>Title “CPC only” text should normally be enclosed in {curly brackets}**</b>	<b>Transferred to#</b>
N	A01K 85/1837	1	{weighted }	
N	A01K 85/1841	1	{with adjustable direction or buoyancy control}	
N	A01K 85/1843	2	{Selective or shiftable lure to line connections }	
N	A01K 85/1847	1	{Hollow bodies }	
N	A01K 85/1851	1	{with hook and line connections extending through or along the body }	
N	A01K 85/1853	1	{Lure slidable on line }	
N	A01K 85/1857	1	{with a hook to line connection interlocked by the lure }	
N	A01K 85/1861	1	{shiftable on strike }	
N	A01K 85/1863	1	{with biasing mechanism generating specific lure motion during line tension }	
N	A01K 85/1867	1	{characterised by the line attachments }	
N	A01K 85/1871	1	{with two or more lures or movably connected rigid lure members }	
N	A01K 85/1873	2	{with at least one member located within the other in a rotatable arrangement }	
N	A01K 85/1877	2	{with two or more movable members arranged offset, e.g. at sides of the body }	
N	A01K 85/1881	2	{movably connected in series }	
N	A01K 85/1883	3	{with one member rotating }	
N	A01K 85/1887	4	{sheet material preceding and rotating }	
N	A01K 85/1891	3	{Lure members made of sheet material }	
N	A01K 85/1893	1	{Motor-operated artificial bait }	
N	A01K 85/1897	1	{Lures characterised by the manufacturing process }	
C	A01K 87/00	0	Fishing rods	A01K 87/00, A01K 87/008, A01K 87/009
C	A01K 87/002	1	{with the line passing through the hollow rod }	A01K 87/002, A01K 87/008, A01K 87/009
C	A01K 87/005	2	{comprising internal line guides }	A01K 87/005, A01K 87/008, A01K 87/009
U	A01K 87/007	1	{with built-in accessories, e.g. lighting means or measuring devices }	

CPC NOTICE OF CHANGES 1252

DATE: FEBRUARY 1, 2022

PROJECT RP0258

<u>Type*</u>	<u>Symbol</u>	<u>Indent Level Number of dots (e.g. 0, 1, 2)</u>	<u>Title</u> <u>“CPC only” text should normally be enclosed in {curly brackets}**</u>	<u>Transferred to#</u>
N	A01K 87/008	1	{with attached auxiliary devices, e.g. for keeping the rod afloat or for line cutting}	
N	A01K 87/009	2	{Hook or tackle holders }	
C	A01K 87/02	1	Connecting devices for parts of the rods	A01K 87/02, A01K 87/008, A01K 87/009
C	A01K 87/025	2	{telescopic }	A01K 87/025, A01K 87/008, A01K 87/009
C	A01K 87/04	1	Fishing-line guides on rods {, e.g. tips (internal line guides A01K 87/005)}	A01K 87/04, A01K 87/008, A01K 87/009
C	A01K 87/06	1	Devices for fixing reels on rods	A01K 87/06, A01K 87/008, A01K 87/009
C	A01K 87/08	1	Handgrips	A01K 87/08, A01K 87/008, A01K 87/009
C	A01K 87/085	2	{Heating devices or other means to protect against the cold}	A01K 87/085, A01K 87/008, A01K 87/009
M	A01K 97/00	0	Accessories for angling (fish stringers A01K 65/00; landing-nets or landing-spoons for fishing A01K 77/00)	
C	A01K 97/06	1	Containers or holders for hooks, lines, sinkers, flies or the like {(attached to a fishing rod A01K 87/009)}	A01K 97/06, A01K 87/009

\*N = new entries where reclassification into entries is involved; C = entries with modified file scope where reclassification of documents from the entries is involved; Q = new entries which are firstly populated with documents via administrative transfers from deleted (D) entries. Afterwards, the transferred documents into the Q entry will either stay or be moved to more appropriate entries, as determined by intellectual reclassification; T = existing entries with enlarged file scope, which receive documents from C or D entries, e.g. when a limiting reference is removed from the entry title; M = entries with no change to the file scope (no reclassification); D = deleted entries; F = frozen entries will be deleted once reclassification of documents from the entries is completed; U = entries that are unchanged.

NOTES:

- \*\*No {curly brackets} are used for titles in CPC only subclasses, e.g. C12Y, A23Y; 2000 series symbol titles of groups found at the end of schemes (orthogonal codes); or the Y section titles. The {curly brackets} are used for 2000 series symbol titles found interspersed throughout the main trunk schemes (breakdown codes).
- U groups: it is obligatory to display the required “anchor” symbol (U group), i.e. the entry immediately preceding a new group or an array of new groups to be created (in case new groups are not clearly subgroups of C-type groups). Always include the symbol, indent level and title of the U group in the table above.
- All entry types should be included in the scheme changes table above for better understanding of the overall scheme change picture. Symbol, indent level, and title are required for all types.
- “Transferred to” column must be completed for all C, D, F, and Q type entries. F groups will be deleted once reclassification is completed.
- When multiple symbols are included in the “Transferred to” column, avoid using ranges of symbols in order to be as precise as possible.
- For administrative transfer of documents, the following text should be used: “< administrative transfer to XX>”, “<administrative transfer to XX and YY simultaneously>”, or “<administrative transfer to XX, YY, ...and ZZ simultaneously>” when administrative transfer of the same documents is to more than one place.
- Administrative transfer to main trunk groups is assumed to be the source allocation type, unless otherwise indicated.

CPC NOTICE OF CHANGES 1252

DATE: FEBRUARY 1, 2022

PROJECT RP0258

- Administrative transfer to 2000/Y series groups is assumed to be “additional information”.
- If needed, instructions for allocation type should be indicated within the angle brackets using the abbreviations “ADD” or “INV”: <administrative transfer to XX ADD> , <administrative transfer to XX INV>, or < administrative transfer to XX ADD, YY INV, ... and ZZ ADD simultaneously>.
- In certain situations, the “D” entries of 2000-series or Y-series groups may not require a destination (“T transferred to”) symbol, however it is required to specify “<no transfer>” in the “T transferred to” column for such cases.
- For finalisation projects, the deleted “F” symbols should have <no transfer> in the “T transferred to” column.
- For more details about the types of scheme change, see CPC Guide.

CPC NOTICE OF CHANGES 1252

DATE: FEBRUARY 1, 2022

PROJECT RP0258

B. New, Modified or Deleted Warning(s)

**SUBCLASS A01K – ANIMAL HUSBANDRY; CARE OF BIRDS, FISHES, INSECTS; FISHING; REARING OR BREEDING ANIMALS, NOT OTHERWISE PROVIDED FOR; NEW BREEDS OF ANIMALS**

<u>Type*</u>	<u>Location</u>	<u>Old Warning</u>	<u>New/Modified Warning</u>
N	A01K 73/02		Group A01K 73/02 is impacted by reclassification into groups A01K 73/063 and A01K 73/067. Groups A01K 73/02, A01K 73/063, and A01K 73/067 should be considered in order to perform a complete search.
N	A01K 73/025		Group A01K 73/025 is impacted by reclassification into groups A01K 73/063 and A01K 73/067. Groups A01K 73/025, A01K 73/063, and A01K 73/067 should be considered in order to perform a complete search.
N	A01K 73/04		Group A01K 73/04 is impacted by reclassification into groups A01K 73/063 and A01K 73/067. Groups A01K 73/04, A01K 73/063, and A01K 73/067 should be considered in order to perform a complete search.
N	A01K 73/045		Group A01K 73/045 is impacted by reclassification into groups A01K 73/063 and A01K 73/067. Groups A01K 73/045, A01K 73/063, and A01K 73/067 should be considered in order to perform a complete search.
N	A01K 73/05		Group A01K 73/05 is impacted by reclassification into groups A01K 73/063 and A01K 73/067. Groups A01K 73/05, A01K 73/063, and A01K 73/067 should be considered in order to perform a complete search.
N	A01K 73/053		Group A01K 73/053 is impacted by reclassification into groups A01K 73/063 and A01K 73/067. Groups A01K 73/053, A01K 73/063, and A01K 73/067 should be considered in order to perform a complete search.
N	A01K 73/06		Group A01K 73/06 is impacted by reclassification into groups A01K 73/063 and A01K 73/067. Groups A01K 73/06, A01K

CPC NOTICE OF CHANGES 1252

DATE: FEBRUARY 1, 2022

PROJECT RP0258

<u>Type*</u>	<u>Location</u>	<u>Old Warning</u>	<u>New/Modified Warning</u>
			73/063, and A01K 73/067 should be considered in order to perform a complete search.
N	A01K 73/063		Group A01K 73/063 is incomplete pending reclassification of documents from groups A01K 73/02, A01K 73/025, A01K 73/04, A01K 73/045, A01K 73/05, A01K 73/053, A01K 73/06, and A01K 73/10. All groups listed in this Warning should be considered in order to perform a complete search.
N	A01K 73/067		Group A01K 73/067 is incomplete pending reclassification of documents from groups A01K 73/02, A01K 73/025, A01K 73/04, A01K 73/045, A01K 73/05, A01K 73/053, A01K 73/06, A01K 73/10, and A01K 79/02. All groups listed in this Warning should be considered in order to perform a complete search.
N	A01K 73/10		Group A01K 73/10 is impacted by reclassification into groups A01K 73/063 and A01K 73/067. Groups A01K 73/10, A01K 73/063, and A01K 73/067 should be considered in order to perform a complete search.
N	A01K 75/00		Group A01K 75/00 is impacted by reclassification into group A01K 75/005. Groups A01K 75/00 and A01K 75/005 should be considered in order to perform a complete search.
N	A01K 75/005		Group A01K 75/005 is incomplete pending reclassification of documents from group A01K 75/00. Groups A01K 75/00 and A01K 75/005 should be considered in order to perform a complete search.
N	A01K 77/00		Group A01K 77/00 is impacted by reclassification into group A01K 77/005. Groups A01K 77/00 and A01K 77/005 should be considered in order to perform a complete search.



CPC NOTICE OF CHANGES 1252

DATE: FEBRUARY 1, 2022

PROJECT RP0258

<u>Type*</u>	<u>Location</u>	<u>Old Warning</u>	<u>New/Modified Warning</u>
N	A01K 77/005		Group A01K 77/005 is incomplete pending reclassification of documents from group A01K 77/00. Groups A01K 77/00 and A01K 77/005 should be considered in order to perform a complete search.
N	A01K 79/02		Group A01K 79/02 is impacted by reclassification into group A01K 73/067. Groups A01K 79/02 and A01K 73/067 should be considered in order to perform a complete search.
N	A01K 80/00		Group A01K 80/00 is impacted by reclassification into group A01K 80/005. Groups A01K 80/00 and A01K 80/005 should be considered in order to perform a complete search.
N	A01K 80/005		Group A01K 80/005 is incomplete pending reclassification of documents from group A01K 80/00. Groups A01K 80/00 and A01K 80/005 should be considered in order to perform a complete search.
N	A01K 83/00		Group A01K 83/00 is impacted by reclassification into groups A01K 83/066, A01K 83/067, and A01K 83/069. All groups listed in this Warning should be considered in order to perform a complete search.
N	A01K 83/02		Group A01K 83/02 is impacted by reclassification into group A01K 83/025. Groups A01K 83/02 and A01K 83/025 should be considered in order to perform a complete search.
N	A01K 83/025		Group A01K 83/025 is incomplete pending reclassification of documents from group A01K 83/02. Groups A01K 83/02 and A01K 83/025 should be considered in order to perform a complete search.
N	A01K 83/04		Group A01K 83/04 is impacted by reclassification into group A01K 83/045. Groups A01K 83/04 and A01K 83/045 should be considered in order to perform a complete search.

CPC NOTICE OF CHANGES 1252

DATE: FEBRUARY 1, 2022

PROJECT RP0258

<u>Type*</u>	<u>Location</u>	<u>Old Warning</u>	<u>New/Modified Warning</u>
N	A01K 83/045		Group A01K 83/045 is incomplete pending reclassification of documents from group A01K 83/04. Groups A01K 83/04 and A01K 83/045 should be considered in order to perform a complete search.
N	A01K 83/06		Group A01K 83/06 is impacted by reclassification into groups A01K 83/061, A01K 83/063, and A01K 83/064. All groups listed in this Warning should be considered in order to perform a complete search.
N	A01K 83/061		Group A01K 83/061 is incomplete pending reclassification of documents from group A01K 83/06. Groups A01K 83/06 and A01K 83/061 should be considered in order to perform a complete search.
N	A01K 83/063		Group A01K 83/063 is incomplete pending reclassification of documents from group A01K 83/06. Groups A01K 83/06 and A01K 83/063 should be considered in order to perform a complete search.
N	A01K 83/064		Group A01K 83/064 is incomplete pending reclassification of documents from group A01K 83/06. Groups A01K 83/06 and A01K 83/064 should be considered in order to perform a complete search.
N	A01K 83/066		Groups A01K 83/066, A01K 83/067, and A01K 83/069 are incomplete pending reclassification of documents from group A01K 83/00. All groups listed in this Warning should be considered in order to perform a complete search.
N	A01K 85/00		Group A01K 85/00 is impacted by reclassification into groups A01K 85/011, A01K 85/012, A01K 85/013, A01K 85/019, A01K 85/026, A01K 85/027, A01K 85/028, A01K 85/029, A01K 85/1803, A01K 85/1807, A01K 85/1811, A01K 85/1813, A01K 85/1817, A01K 85/1821,

CPC NOTICE OF CHANGES 1252

DATE: FEBRUARY 1, 2022

PROJECT RP0258

<u>Type*</u>	<u>Location</u>	<u>Old Warning</u>	<u>New/Modified Warning</u>
			A01K 85/1823, A01K 85/1827, A01K 85/1831, A01K 85/1833, A01K 85/1837, A01K 85/1841, A01K 85/1843, A01K 85/1847, A01K 85/1851, A01K 85/1853, A01K 85/1857, A01K 85/1861, A01K 85/1863, A01K 85/1867, A01K 85/1871, A01K 85/1873, A01K 85/1877, A01K 85/1881, A01K 85/1883, A01K 85/1887, A01K 85/1891, A01K 85/1893, and A01K 85/1897. All groups listed in this Warning should be considered in order to perform a complete search.
N	A01K 85/005		Group A01K 85/005 is impacted by reclassification into groups A01K 85/011, A01K 85/012, A01K 85/013, A01K 85/019, A01K 85/026, A01K 85/027, A01K 85/028, A01K 85/029, A01K 85/1803, A01K 85/1807, A01K 85/1811, A01K 85/1813, A01K 85/1817, A01K 85/1821, A01K 85/1823, A01K 85/1827, A01K 85/1831, A01K 85/1833, A01K 85/1837, A01K 85/1841, A01K 85/1843, A01K 85/1847, A01K 85/1851, A01K 85/1853, A01K 85/1857, A01K 85/1861, A01K 85/1863, A01K 85/1867, A01K 85/1871, A01K 85/1873, A01K 85/1877, A01K 85/1881, A01K 85/1883, A01K 85/1887, A01K 85/1891, A01K 85/1893, and A01K 85/1897. All groups listed in this Warning should be considered in order to perform a complete search.
N	A01K 85/01		Group A01K 85/01 is impacted by reclassification into groups A01K 85/011, A01K 85/012, A01K 85/013, A01K 85/015, A01K 85/017, A01K 85/018, A01K 85/019, A01K 85/026, A01K 85/027, A01K 85/028, A01K 85/029, A01K 85/1803, A01K 85/1807, A01K 85/1811, A01K 85/1813, A01K 85/1817, A01K 85/1821, A01K 85/1823, A01K 85/1827, A01K 85/1831, A01K 85/1833, A01K 85/1837,

CPC NOTICE OF CHANGES 1252

DATE: FEBRUARY 1, 2022

PROJECT RP0258

<u>Type*</u>	<u>Location</u>	<u>Old Warning</u>	<u>New/Modified Warning</u>
			A01K 85/1841, A01K 85/1843, A01K 85/1847, A01K 85/1851, A01K 85/1853, A01K 85/1857, A01K 85/1861, A01K 85/1863, A01K 85/1867, A01K 85/1871, A01K 85/1873, A01K 85/1877, A01K 85/1881, A01K 85/1883, A01K 85/1887, A01K 85/1891, A01K 85/1893, and A01K 85/1897. All groups listed in this Warning should be considered in order to perform a complete search.
N	A01K 85/011		Groups A01K 85/011, A01K 85/012, and A01K 85/013 are incomplete pending reclassification of documents from groups A01K 85/00, A01K 85/005, A01K 85/01, A01K 85/02, A01K 85/08, A01K 85/10, A01K 85/12, A01K 85/14, A01K 85/16, and A01K 85/18. All groups listed in this Warning should be considered in order to perform a complete search.
N	A01K 85/015		Group A01K 85/015 is incomplete pending reclassification of documents from group A01K 85/01. Groups A01K 85/01 and A01K 85/015 should be considered in order to perform a complete search.
N	A01K 85/017		Group A01K 85/017 is incomplete pending reclassification of documents from group A01K 85/01. Groups A01K 85/01 and A01K 85/017 should be considered in order to perform a complete search.
N	A01K 85/018		Group A01K 85/018 is incomplete pending reclassification of documents from group A01K 85/01. Groups A01K 85/01 and A01K 85/018 should be considered in order to perform a complete search.
N	A01K 85/019		Group A01K 85/019 is incomplete pending reclassification of documents from groups A01K 85/00, A01K 85/005, A01K 85/01, A01K 85/02, A01K 85/08, A01K 85/10,

CPC NOTICE OF CHANGES 1252

DATE: FEBRUARY 1, 2022

PROJECT RP0258

<u>Type*</u>	<u>Location</u>	<u>Old Warning</u>	<u>New/Modified Warning</u>
			A01K 85/12, A01K 85/14, A01K 85/16, and A01K 85/18. All groups listed in this Warning should be considered in order to perform a complete search.
N	A01K 85/02		Group A01K 85/02 is impacted by reclassification into groups A01K 85/021, A01K 85/022, A01K 85/023, A01K 85/024, A01K 85/025, A01K 85/011, A01K 85/012, A01K 85/013, A01K 85/019, A01K 85/026, A01K 85/027, A01K 85/028, A01K 85/029, A01K 85/1803, A01K 85/1807, A01K 85/1811, A01K 85/1813, A01K 85/1817, A01K 85/1821, A01K 85/1823, A01K 85/1827, A01K 85/1831, A01K 85/1833, A01K 85/1837, A01K 85/1841, A01K 85/1843, A01K 85/1847, A01K 85/1851, A01K 85/1853, A01K 85/1857, A01K 85/1861, A01K 85/1863, A01K 85/1867, A01K 85/1871, A01K 85/1873, A01K 85/1877, A01K 85/1881, A01K 85/1883, A01K 85/1887, A01K 85/1891, A01K 85/1893, and A01K 85/1897. All groups listed in this Warning should be considered in order to perform a complete search.
N	A01K 85/021		Group A01K 85/021 is incomplete pending reclassification of documents from group A01K 85/02. Groups A01K 85/02 and A01K 85/021 should be considered in order to perform a complete search.
N	A01K 85/022		Groups A01K 85/022, A01K 85/023, A01K 85/024, and A01K 85/025 are incomplete pending reclassification of documents from group A01K 85/02. All groups listed in this Warning should be considered in order to perform a complete search.
N	A01K 85/026		Groups A01K 85/026, A01K 85/027, and A01K 85/028 are incomplete pending reclassification of documents from groups A01K 85/00, A01K

CPC NOTICE OF CHANGES 1252

DATE: FEBRUARY 1, 2022

PROJECT RP0258

<u>Type*</u>	<u>Location</u>	<u>Old Warning</u>	<u>New/Modified Warning</u>
			85/005, A01K 85/01, A01K 85/02, A01K 85/08, A01K 85/10, A01K 85/12, A01K 85/14, A01K 85/16, and A01K 85/18. All groups listed in this Warning should be considered in order to perform a complete search.
N	A01K 85/029		Group A01K 85/029 is incomplete pending reclassification of documents from groups A01K 85/00, A01K 85/005, A01K 85/01, A01K 85/02, A01K 85/08, A01K 85/10, A01K 85/12, A01K 85/14, A01K 85/16, and A01K 85/18. All groups listed in this Warning should be considered in order to perform a complete search.
N	A01K 85/08		Group A01K 85/08 is impacted by reclassification into groups A01K 85/011, A01K 85/012, A01K 85/013, A01K 85/019, A01K 85/026, A01K 85/027, A01K 85/028, A01K 85/029, A01K 85/1803, A01K 85/1807, A01K 85/1811, A01K 85/1813, A01K 85/1817, A01K 85/1821, A01K 85/1823, A01K 85/1827, A01K 85/1831, A01K 85/1833, A01K 85/1837, A01K 85/1841, A01K 85/1843, A01K 85/1847, A01K 85/1851, A01K 85/1853, A01K 85/1857, A01K 85/1861, A01K 85/1863, A01K 85/1867, A01K 85/1871, A01K 85/1873, A01K 85/1877, A01K 85/1881, A01K 85/1883, A01K 85/1887, A01K 85/1891, A01K 85/1893, and A01K 85/1897. All groups listed in this Warning should be considered in order to perform a complete search.
N	A01K 85/10		Group A01K 85/10 is impacted by reclassification into groups A01K 85/011, A01K 85/012, A01K 85/013, A01K 85/019, A01K 85/026, A01K 85/027, A01K 85/028, A01K 85/029, A01K 85/1803, A01K 85/1807, A01K 85/1811, A01K 85/1813, A01K 85/1817, A01K 85/1821, A01K 85/1823, A01K 85/1827,

CPC NOTICE OF CHANGES 1252

DATE: FEBRUARY 1, 2022

PROJECT RP0258

<u>Type*</u>	<u>Location</u>	<u>Old Warning</u>	<u>New/Modified Warning</u>
			A01K 85/1831, A01K 85/1833, A01K 85/1837, A01K 85/1841, A01K 85/1843, A01K 85/1847, A01K 85/1851, A01K 85/1853, A01K 85/1857, A01K 85/1861, A01K 85/1863, A01K 85/1867, A01K 85/1871, A01K 85/1873, A01K 85/1877, A01K 85/1881, A01K 85/1883, A01K 85/1887, A01K 85/1891, A01K 85/1893, and A01K 85/1897. All groups listed in this Warning should be considered in order to perform a complete search.
N	A01K 85/12		Group A01K 85/12 is impacted by reclassification into groups A01K 85/122, A01K 85/125, A01K 85/128, A01K 85/011, A01K 85/012, A01K 85/013, A01K 85/019, A01K 85/026, A01K 85/027, A01K 85/028, A01K 85/029, A01K 85/1803, A01K 85/1807, A01K 85/1811, A01K 85/1813, A01K 85/1817, A01K 85/1821, A01K 85/1823, A01K 85/1827, A01K 85/1831, A01K 85/1833, A01K 85/1837, A01K 85/1841, A01K 85/1843, A01K 85/1847, A01K 85/1851, A01K 85/1853, A01K 85/1857, A01K 85/1861, A01K 85/1863, A01K 85/1867, A01K 85/1871, A01K 85/1873, A01K 85/1877, A01K 85/1881, A01K 85/1883, A01K 85/1887, A01K 85/1891, A01K 85/1893, and A01K 85/1897. All groups listed in this Warning should be considered in order to perform a complete search.
N	A01K 85/122		Group A01K 85/122 is incomplete pending reclassification of documents from group A01K 85/12. Groups A01K 85/12 and A01K 85/122 should be considered in order to perform a complete search.
N	A01K 85/125		Groups A01K 85/125 and A01K 85/128 are incomplete pending reclassification of documents from group A01K 85/12. Groups A01K 85/12, A01K 85/125, and

CPC NOTICE OF CHANGES 1252

DATE: FEBRUARY 1, 2022

PROJECT RP0258

<u>Type*</u>	<u>Location</u>	<u>Old Warning</u>	<u>New/Modified Warning</u>
			A01K 85/128 should be considered in order to perform a complete search.
N	A01K 85/14		Group A01K 85/14 is impacted by reclassification into groups A01K 85/143, A01K 85/147, A01K 85/011, A01K 85/012, A01K 85/013, A01K 85/019, A01K 85/026, A01K 85/027, A01K 85/028, A01K 85/029, A01K 85/1803, A01K 85/1807, A01K 85/1811, A01K 85/1813, A01K 85/1817, A01K 85/1821, A01K 85/1823, A01K 85/1827, A01K 85/1831, A01K 85/1833, A01K 85/1837, A01K 85/1841, A01K 85/1843, A01K 85/1847, A01K 85/1851, A01K 85/1853, A01K 85/1857, A01K 85/1861, A01K 85/1863, A01K 85/1867, A01K 85/1871, A01K 85/1873, A01K 85/1877, A01K 85/1881, A01K 85/1883, A01K 85/1887, A01K 85/1891, A01K 85/1893, and A01K 85/1897. All groups listed in this Warning should be considered in order to perform a complete search.
N	A01K 85/143		Group A01K 85/143 is incomplete pending reclassification of documents from group A01K 85/14. Groups A01K 85/14 and A01K 85/143 should be considered in order to perform a complete search.
N	A01K 85/147		Group A01K 85/147 is incomplete pending reclassification of documents from group A01K 85/14. Groups A01K 85/14 and A01K 85/147 should be considered in order to perform a complete search.
N	A01K 85/16		Group A01K 85/16 is impacted by reclassification into groups A01K 85/011, A01K 85/012, A01K 85/013, A01K 85/019, A01K 85/026, A01K 85/027, A01K 85/028, A01K 85/029, A01K 85/1803, A01K 85/1807, A01K 85/1811, A01K 85/1813, A01K 85/1817, A01K 85/1821, A01K 85/1823, A01K 85/1827,



CPC NOTICE OF CHANGES 1252

DATE: FEBRUARY 1, 2022

PROJECT RP0258

<u>Type*</u>	<u>Location</u>	<u>Old Warning</u>	<u>New/Modified Warning</u>
			A01K 85/1831, A01K 85/1833, A01K 85/1837, A01K 85/1841, A01K 85/1843, A01K 85/1847, A01K 85/1851, A01K 85/1853, A01K 85/1857, A01K 85/1861, A01K 85/1863, A01K 85/1867, A01K 85/1871, A01K 85/1873, A01K 85/1877, A01K 85/1881, A01K 85/1883, A01K 85/1887, A01K 85/1891, A01K 85/1893, and A01K 85/1897. All groups listed in this Warning should be considered in order to perform a complete search.
N	A01K 85/18		Group A01K 85/18 is impacted by reclassification into groups A01K 85/011, A01K 85/012, A01K 85/013, A01K 85/019, A01K 85/026, A01K 85/027, A01K 85/028, A01K 85/029, A01K 85/1803, A01K 85/1807, A01K 85/1811, A01K 85/1813, A01K 85/1817, A01K 85/1821, A01K 85/1823, A01K 85/1827, A01K 85/1831, A01K 85/1833, A01K 85/1837, A01K 85/1841, A01K 85/1843, A01K 85/1847, A01K 85/1851, A01K 85/1853, A01K 85/1857, A01K 85/1861, A01K 85/1863, A01K 85/1867, A01K 85/1871, A01K 85/1873, A01K 85/1877, A01K 85/1881, A01K 85/1883, A01K 85/1887, A01K 85/1891, A01K 85/1893, and A01K 85/1897. All groups listed in this Warning should be considered in order to perform a complete search.
N	A01K 85/1803		Group A01K 85/1803 is incomplete pending reclassification of documents from groups A01K 85/00, A01K 85/005, A01K 85/01, A01K 85/02, A01K 85/08, A01K 85/10, A01K 85/12, A01K 85/14, A01K 85/16, and A01K 85/18. All groups listed in this Warning should be considered in order to perform a complete search.
N	A01K 85/1807		Group A01K 85/1807 is incomplete pending reclassification of documents

CPC NOTICE OF CHANGES 1252

DATE: FEBRUARY 1, 2022

PROJECT RP0258

<u>Type*</u>	<u>Location</u>	<u>Old Warning</u>	<u>New/Modified Warning</u>
			from groups A01K 85/00, A01K 85/005, A01K 85/01, A01K 85/02, A01K 85/08, A01K 85/10, A01K 85/12, A01K 85/14, A01K 85/16, and A01K 85/18. All groups listed in this Warning should be considered in order to perform a complete search.
N	A01K 85/1811		Groups A01K 85/1811, A01K 85/1813, A01K 85/1817, A01K 85/1821, A01K 85/1823, and A01K 85/1827 are incomplete pending reclassification of documents from groups A01K 85/00, A01K 85/005, A01K 85/01, A01K 85/02, A01K 85/08, A01K 85/10, A01K 85/12, A01K 85/14, A01K 85/16, and A01K 85/18. All groups listed in this Warning should be considered in order to perform a complete search.
N	A01K 85/1831		Groups A01K 85/1831 and A01K 85/1833 are incomplete pending reclassification of documents from groups A01K 85/00, A01K 85/005, A01K 85/01, A01K 85/02, A01K 85/08, A01K 85/10, A01K 85/12, A01K 85/14, A01K 85/16, and A01K 85/18. All groups listed in this Warning should be considered in order to perform a complete search.
N	A01K 85/1837		Group A01K 85/1837 is incomplete pending reclassification of documents from groups A01K 85/00, A01K 85/005, A01K 85/01, A01K 85/02, A01K 85/08, A01K 85/10, A01K 85/12, A01K 85/14, A01K 85/16, and A01K 85/18. All groups listed in this Warning should be considered in order to perform a complete search.
N	A01K 85/1841		Groups A01K 85/1841 and A01K 85/1843 are incomplete pending reclassification of documents from groups A01K 85/00, A01K 85/005, A01K 85/01, A01K 85/02, A01K 85/08, A01K 85/10, A01K 85/12, A01K 85/14, A01K 85/16, and A01K 85/18. All

CPC NOTICE OF CHANGES 1252

DATE: FEBRUARY 1, 2022

PROJECT RP0258

<u>Type*</u>	<u>Location</u>	<u>Old Warning</u>	<u>New/Modified Warning</u>
			groups listed in this Warning should be considered in order to perform a complete search.
N	A01K 85/1847		Group A01K 85/1847 is incomplete pending reclassification of documents from groups A01K 85/00, A01K 85/005, A01K 85/01, A01K 85/02, A01K 85/08, A01K 85/10, A01K 85/12, A01K 85/14, A01K 85/16, and A01K 85/18. All groups listed in this Warning should be considered in order to perform a complete search.
N	A01K 85/1851		Group A01K 85/1851 is incomplete pending reclassification of documents from groups A01K 85/00, A01K 85/005, A01K 85/01, A01K 85/02, A01K 85/08, A01K 85/10, A01K 85/12, A01K 85/14, A01K 85/16, and A01K 85/18. All groups listed in this Warning should be considered in order to perform a complete search.
N	A01K 85/1853		Group A01K 85/1853 is incomplete pending reclassification of documents from groups A01K 85/00, A01K 85/005, A01K 85/01, A01K 85/02, A01K 85/08, A01K 85/10, A01K 85/12, A01K 85/14, A01K 85/16, and A01K 85/18. All groups listed in this Warning should be considered in order to perform a complete search.
N	A01K 85/1857		Group A01K 85/1857 is incomplete pending reclassification of documents from groups A01K 85/00, A01K 85/005, A01K 85/01, A01K 85/02, A01K 85/08, A01K 85/10, A01K 85/12, A01K 85/14, A01K 85/16, and A01K 85/18. All groups listed in this Warning should be considered in order to perform a complete search.
N	A01K 85/1861		Group A01K 85/1861 is incomplete pending reclassification of documents from groups A01K 85/00, A01K 85/005, A01K 85/01, A01K

CPC NOTICE OF CHANGES 1252

DATE: FEBRUARY 1, 2022

PROJECT RP0258

<u>Type*</u>	<u>Location</u>	<u>Old Warning</u>	<u>New/Modified Warning</u>
			85/02, A01K 85/08, A01K 85/10, A01K 85/12, A01K 85/14, A01K 85/16, and A01K 85/18. All groups listed in this Warning should be considered in order to perform a complete search.
N	A01K 85/1863		Group A01K 85/1863 is incomplete pending reclassification of documents from groups A01K 85/00, A01K 85/005, A01K 85/01, A01K 85/02, A01K 85/08, A01K 85/10, A01K 85/12, A01K 85/14, A01K 85/16, and A01K 85/18. All groups listed in this Warning should be considered in order to perform a complete search.
N	A01K 85/1867		Group A01K 85/1867 is incomplete pending reclassification of documents from groups A01K 85/00, A01K 85/005, A01K 85/01, A01K 85/02, A01K 85/08, A01K 85/10, A01K 85/12, A01K 85/14, A01K 85/16, and A01K 85/18. All groups listed in this Warning should be considered in order to perform a complete search.
N	A01K 85/1871		Groups A01K 85/1871, A01K 85/1873, A01K 85/1877, A01K 85/1881, A01K 85/1883, A01K 85/1887, and A01K 85/1891 are incomplete pending reclassification of documents from groups A01K 85/00, A01K 85/005, A01K 85/01, A01K 85/02, A01K 85/08, A01K 85/10, A01K 85/12, A01K 85/14, A01K 85/16, and A01K 85/18. All groups listed in this Warning should be considered in order to perform a complete search.
N	A01K 85/1893		Group A01K 85/1893 is incomplete pending reclassification of documents from groups A01K 85/00, A01K 85/005, A01K 85/01, A01K 85/02, A01K 85/08, A01K 85/10, A01K 85/12, A01K 85/14, A01K 85/16, and A01K 85/18. All groups listed in this Warning

CPC NOTICE OF CHANGES 1252

DATE: FEBRUARY 1, 2022

PROJECT RP0258

<u>Type*</u>	<u>Location</u>	<u>Old Warning</u>	<u>New/Modified Warning</u>
			should be considered in order to perform a complete search.
N	A01K 85/1897		Group A01K 85/1897 is incomplete pending reclassification of documents from groups A01K 85/00, A01K 85/005, A01K 85/01, A01K 85/02, A01K 85/08, A01K 85/10, A01K 85/12, A01K 85/14, A01K 85/16, and A01K 85/18. All groups listed in this Warning should be considered in order to perform a complete search.
N	A01K 87/00		Group A01K 87/00 is impacted by reclassification into groups A01K 87/008 and A01K 87/009. Groups A01K 87/00, A01K 87/008, and A01K 87/009 should be considered in order to perform a complete search.
N	A01K 87/002		Group A01K 87/002 is impacted by reclassification into groups A01K 87/008 and A01K 87/009. Groups A01K 87/002, A01K 87/008, and A01K 87/009 should be considered in order to perform a complete search.
N	A01K 87/005		Group A01K 87/005 is impacted by reclassification into groups A01K 87/008 and A01K 87/009. Groups A01K 87/005, A01K 87/008, and A01K 87/009 should be considered in order to perform a complete search.
N	A01K 87/008		Group A01K 87/008 is incomplete pending reclassification of documents from groups A01K 87/00, A01K 87/002, A01K 87/005, A01K 87/02, A01K 87/025, A01K 87/04, A01K 87/06, A01K 87/08, and A01K 87/085. All groups listed in this Warning should be considered in order to perform a complete search.
N	A01K 87/009		Group A01K 87/009 is incomplete pending reclassification of documents from groups A01K 87/00, A01K 87/002, A01K 87/005, A01K 87/02, A01K 87/025, A01K 87/04, A01K 87/06, A01K 87/08,

CPC NOTICE OF CHANGES 1252

DATE: FEBRUARY 1, 2022

PROJECT RP0258

<u>Type*</u>	<u>Location</u>	<u>Old Warning</u>	<u>New/Modified Warning</u>
			A01K 87/085, and A01K 97/06. All groups listed in this Warning should be considered in order to perform a complete search.
N	A01K 87/02		Group A01K 87/02 is impacted by reclassification into groups A01K 87/008 and A01K 87/009. Groups A01K 87/02, A01K 87/008, and A01K 87/009 should be considered in order to perform a complete search.
N	A01K 87/025		Group A01K 87/025 is impacted by reclassification into groups A01K 87/008 and A01K 87/009. Groups A01K 87/025, A01K 87/008, and A01K 87/009 should be considered in order to perform a complete search.
N	A01K 87/04		Group A01K 87/04 is impacted by reclassification into groups A01K 87/008 and A01K 87/009. Groups A01K 87/04, A01K 87/008, and A01K 87/009 should be considered in order to perform a complete search.
N	A01K 87/06		Group A01K 87/06 is impacted by reclassification into groups A01K 87/008 and A01K 87/009. Groups A01K 87/06, A01K 87/008, and A01K 87/009 should be considered in order to perform a complete search.
N	A01K 87/08		Group A01K 87/08 is impacted by reclassification into groups A01K 87/008 and A01K 87/009. Groups A01K 87/08, A01K 87/008, and A01K 87/009 should be considered in order to perform a complete search.
N	A01K 87/085		Group A01K 87/085 is impacted by reclassification into groups A01K 87/008 and A01K 87/009. Groups A01K 87/085, A01K 87/008, and A01K 87/009 should be considered in order to perform a complete search.
N	A01K 97/06		Group A01K 97/06 is impacted by reclassification into group A01K 87/009. Groups A01K 97/06 and A01K 87/009 should be considered in order to perform a complete search.

CPC NOTICE OF CHANGES 1252

DATE: FEBRUARY 1, 2022

PROJECT RP0258

\*N = new warning, M = modified warning, D = deleted warning

NOTE: The "Location" column only requires the symbol PRIOR to the location of the warning. No further directions such as "before" or "after" are required.

CPC NOTICE OF CHANGES 1252

DATE: FEBRUARY 1, 2022

PROJECT RP0258

D. New, Modified or Deleted Guidance Heading(s)

**SUBCLASS A01K – ANIMAL HUSBANDRY; CARE OF BIRDS, FISHES, INSECTS; FISHING; REARING OR BREEDING ANIMALS, NOT OTHERWISE PROVIDED FOR; NEW BREEDS OF ANIMALS**

<u>Type*</u>	<u>Location</u>	<u>Old Guidance Heading</u>	<u>New/Modified Guidance Heading</u>
M	A01K 1/00	Animal husbandry in general, especially cattle-raising (devices in connection with harnesses B68B)	Animal husbandry in general, especially cattle-raising
M	A01K 47/00	Apiculture {(rearing insects in general A01K 67/00)}	Apiculture
M	A01K 69/00	Fishing (fish stringers A01K 65/00)	Fishing

\*N = new guidance heading, M =modified guidance heading, D = deleted guidance heading

NOTES:

- The “Location” column requires the symbol AFTER the guidance heading location. No further directions such as “before” or “after” are required.
- In cases where there may be confusion as to whether a new group falls within the scope of a guidance heading, indicate the guidance heading and whether the group does or does not go with the guidance heading. This can be included in the “Location” column. For example, the guidance heading “Compounds containing carbon together with sulfur, selenium or tellurium with or without hydrogen, halogens, oxygen or nitrogen” encompasses groups C07C 301/00-395/00 only. If a new group C07C 398/00 is proposed and is included in the guidance heading scope, indicate this in the “Location” column as follows: 398/00 to be included under the guidance heading: “Compounds containing carbon together with sulfur, selenium or tellurium with or without hydrogen, halogens, oxygen or nitrogen.”



## 2. A. DEFINITIONS (new)

### A01K 73/063

#### Definition statement

*This place covers:*

Trawling nets with structure for causing an unwanted item, including debris or an undesired fish or other aquatic animal, to either pass through or by the net or to be retained in a separate section of the net so that a targeted fish or other aquatic animal may be retained in the net or separated from the unwanted item.

Illustrative example of subject matter classified in this group.

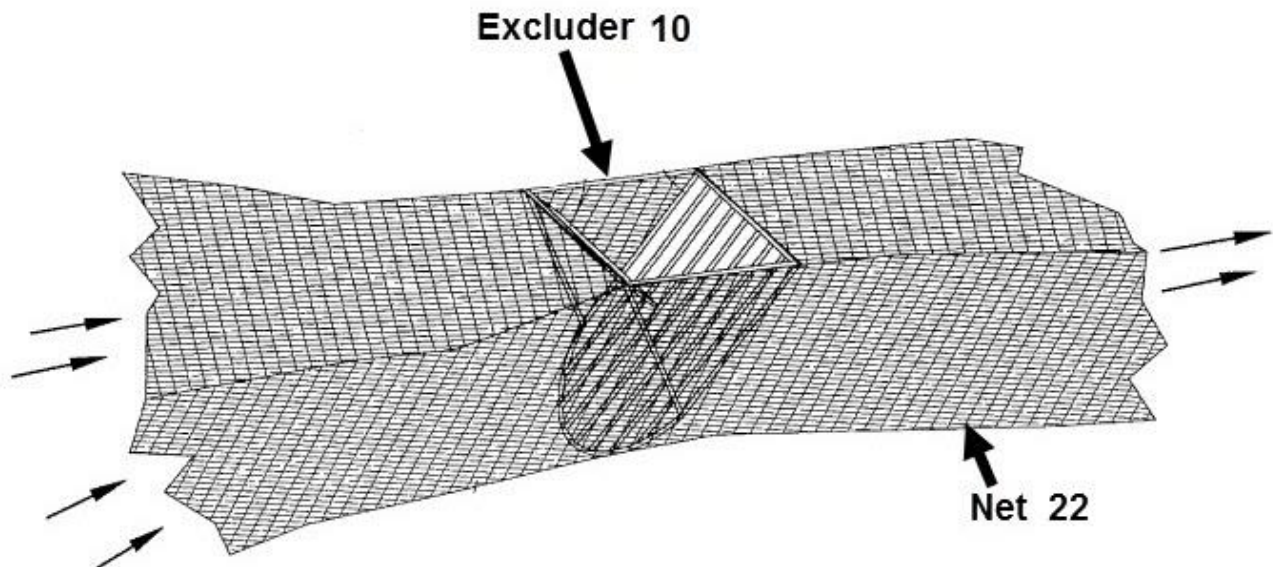

DATE: FEBRUARY 1, 2022

PROJECT RP0258

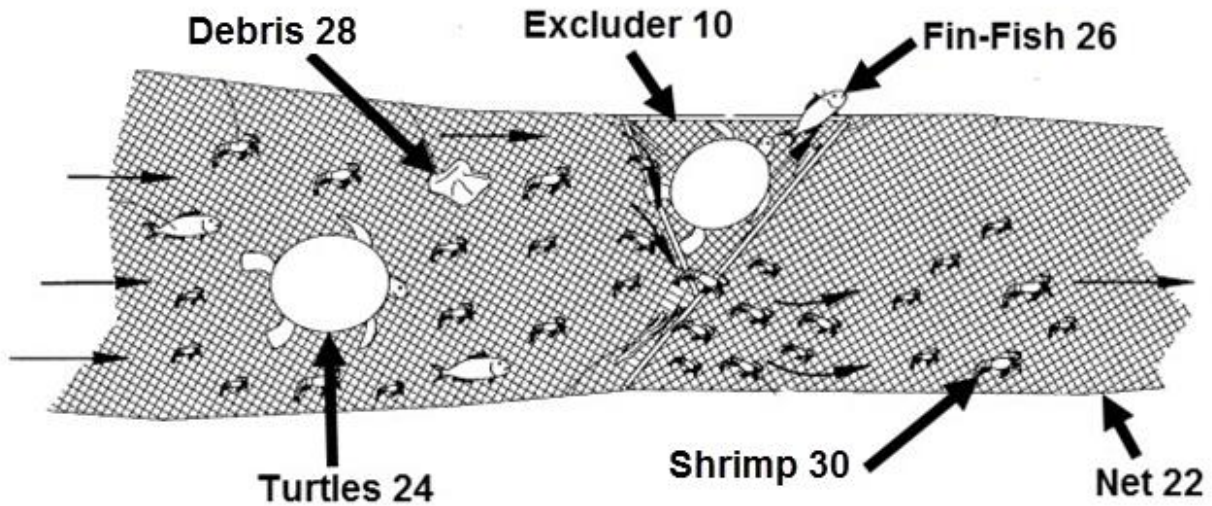

The net 22 includes an excluder device 10 which causes unwanted items, such as turtles 24, fin-fish 26, and debris 28 to pass by the net 22 so that the targeted aquatic animal, such as shrimp 30, may be retained in the net 22 and separated from the unwanted items.

## **A01K 73/067**

### **Definition statement**

*This place covers:*

Trawling nets which use electric current to provide a charge which may lure, reposition, stun or otherwise influence the fish or other aquatic animal.

Illustrative example of subject matter classified in this group.

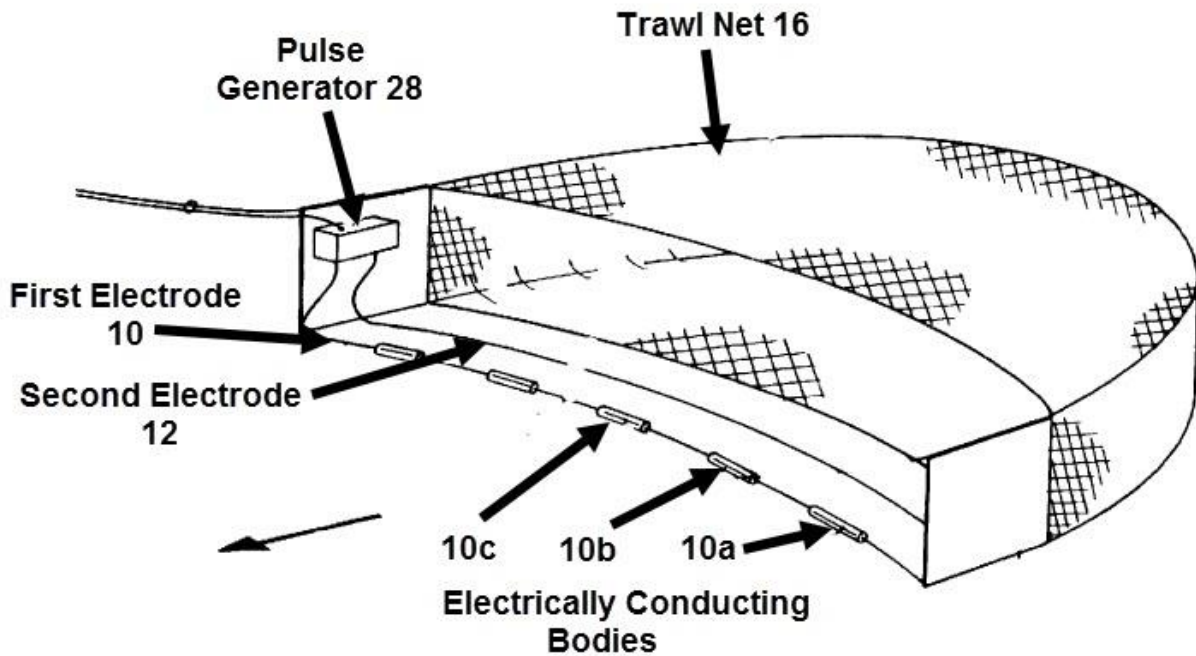

The trawl net 16 has a first electrode 10 comprising separate electrically conducting bodies 10a-c, a second electrode 12, and a pulse generator 28 which is connected to the electrodes 10,12 to generate during operation a pulsed electric field in the water.

## **A01K 75/005**

### **Definition statement**

*This place covers:*

Trawling nets wherein significance is attributed to the structural makeup of the trawling nets.

Illustrative example of subject matter classified in this group.

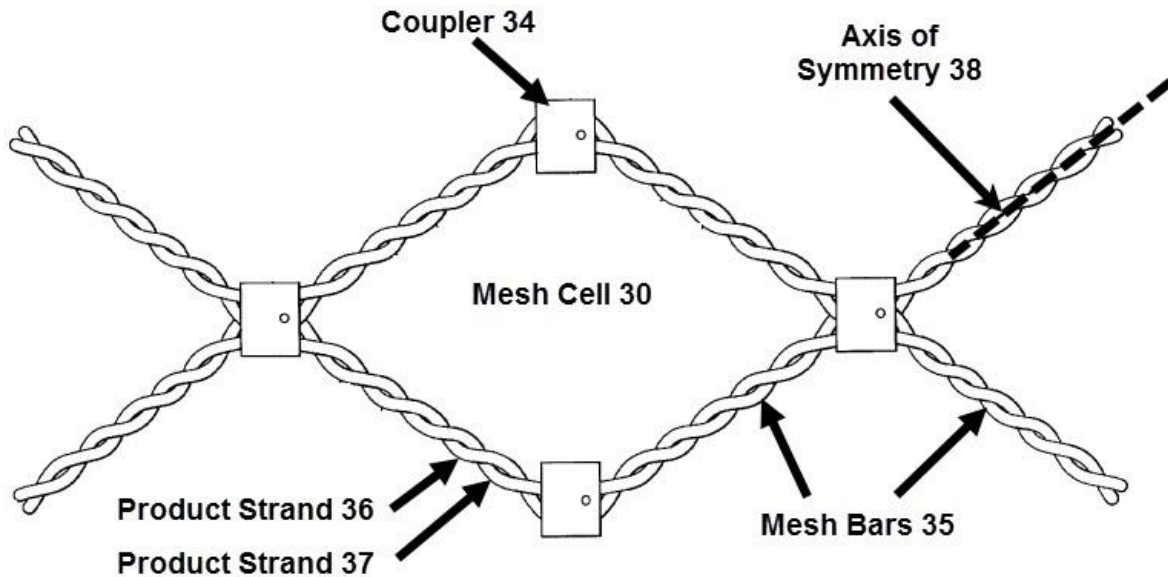

The mesh cell 30 forms part of a trawling net and is formed by couplers 34 and a series of mesh bars 35 that include several product strands 36,37 which are twisted about a common axis of symmetry 38, wherein the mesh bars 35 create a pressure differential and lift across the mesh bars 35 as the trawling net moves through the water, wherein the created lift increases performance characteristics of the trawling net such as increased trawl volume, improved trawl shape, and reduced vibration, noise, and drag.

DATE: FEBRUARY 1, 2022

PROJECT RP0258

## A01K 77/005

### Definition statement

*This place covers:*

Landing-nets with parts which are foldable or collapsible for greater ease in carrying, or with parts which can be so manipulated as to secure a caught fish.

Illustrative example of subject matter classified in this group.

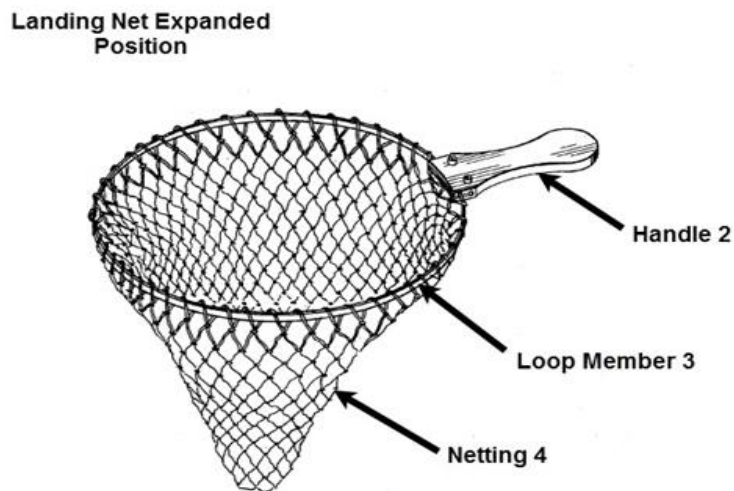

The landing net has a handle 2, loop member 3, and netting 4, wherein the loop member 3 is circular in the expanded position and wherein the loop member 3 may be completely folded into a series of convolutions in the collapsed position.

**Landing Net  
Collapsed Position**

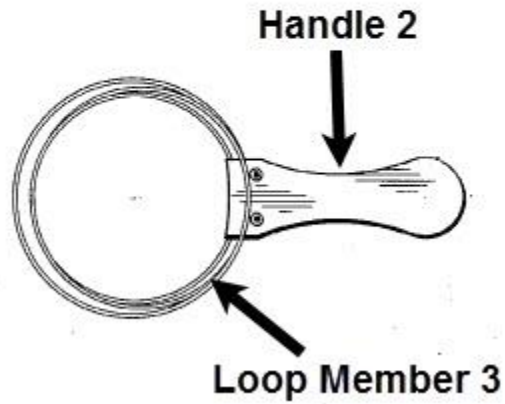

**Landing Net Open Position**

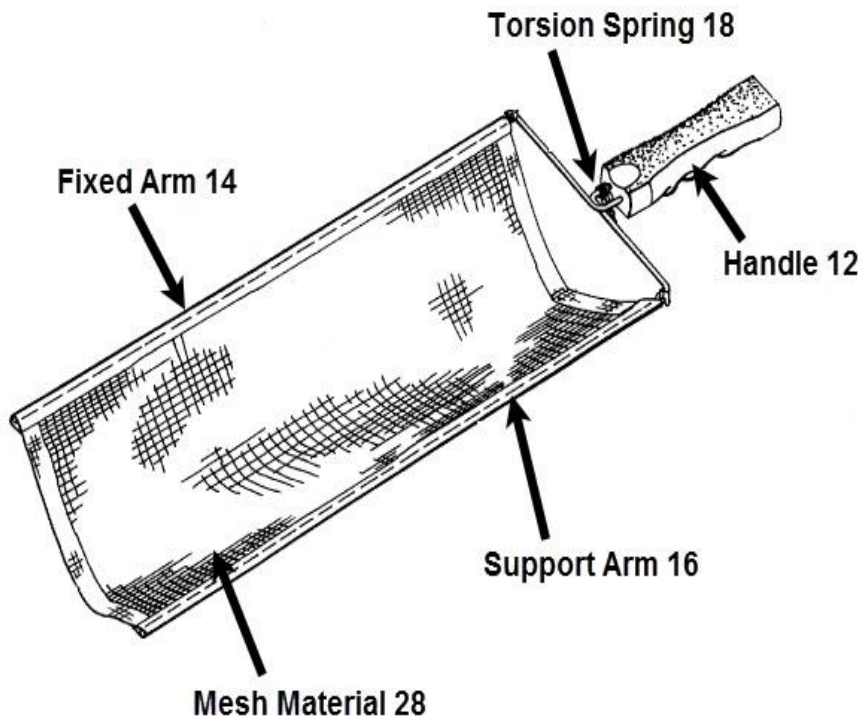



DATE: FEBRUARY 1, 2022

PROJECT RP0258

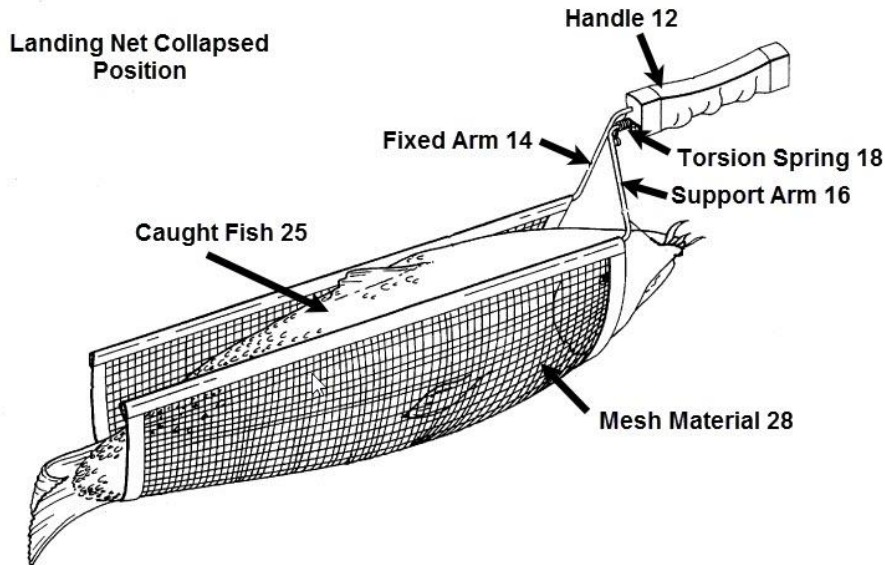

The landing net has a handle 12, a fixed arm 14 and a support arm 16 which both support mesh material 28, and a torsion spring 18 which moves arm 16 into the open position away from the fixed arm 14, wherein when a caught fish 25 is received in the mesh material 28, the caught fish 25 will cause arm 16 to rotate toward fixed arm 14, thereby collapsing the mesh material 28 around the fish.

## A01K 80/005

### Definition statement

*This place covers:*

Trawling nets with a runner construction for supporting a net during travel along the bottom of the body of water.

Illustrative example of subject matter classified in this group.

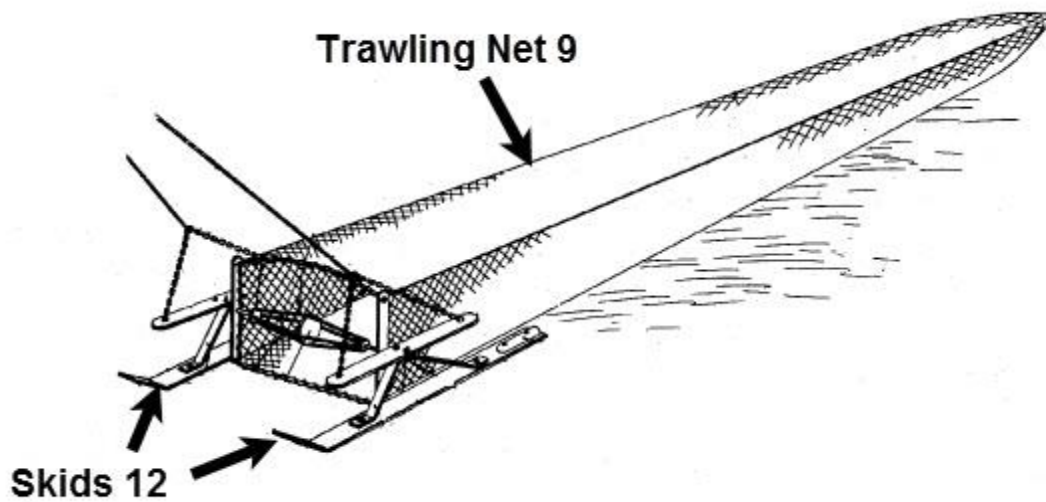

Trawling net 9 has a runner construction in the form of a pair of skids 12 which support the trawling net 9 during travel along the bottom of the body of water.

## **A01K 83/025**

### **Definition statement**

*This place covers:*

Trap-hooks actuated only by a pull, either from the fish or from the fisherman, or both, and not by a spring or weight.

Illustrative example of subject matter classified in this group.



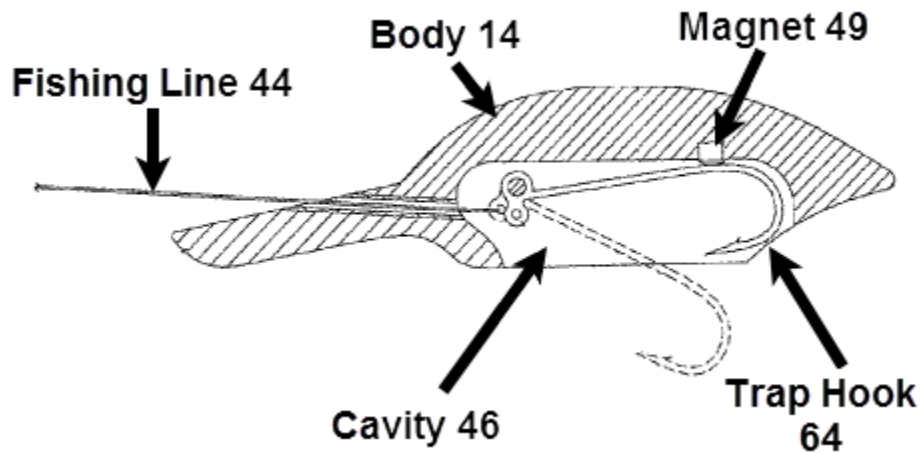

A trap hook 64 is mounted inside a cavity 46 of a body 14 of a fishing lure where it is retained within the cavity 46 by a magnet 49 and one end of fishing line 44 is attached to hook 64 and when the other end of the fishing line 44 is pulled by the fisherman, the trap hook 64 moves to a position outside of the cavity 46 in order to hook the fish.

## **A01K 83/045**

### **Definition statement**

*This place covers:*

Trap hooks with special gripping arms, wherein the trap hooks are actuated only by a pull, either from the fish or from the fisherman, or both, and not by a spring or weight.

Illustrative example of subject matter classified in this group.

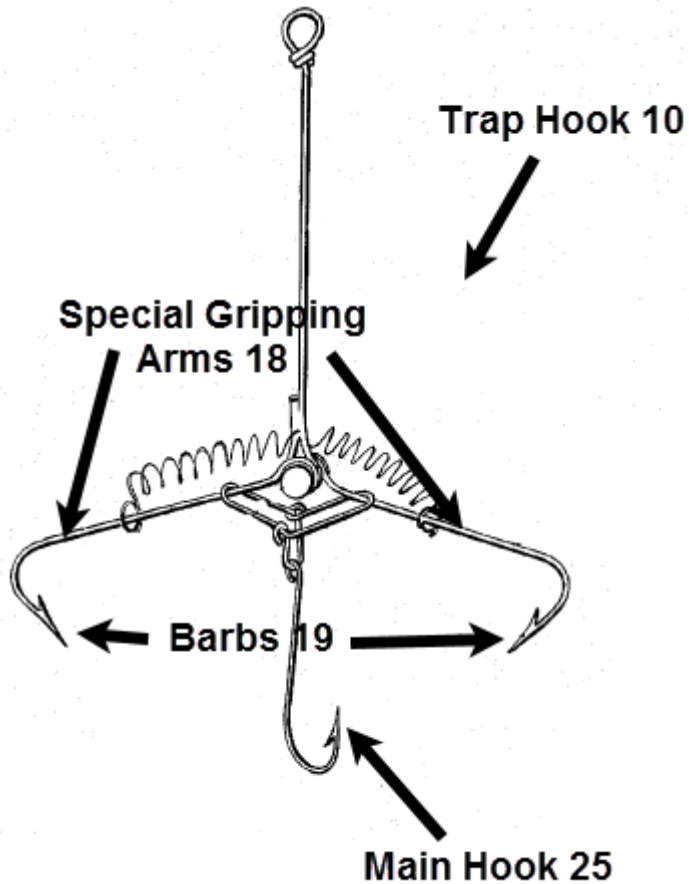

A trap hook 10 has special gripping arms 18 with barbs 19 and a main hook 25, wherein the trap hook 10 is actuated by a pull from the fish upon the main hook 25 which causes the arms 18 with barbs 19 to move toward each other to engage the fish.

## **A01K 83/061**

### **Definition statement**

*This place covers:*

Bait holders and retainers in which at least one element substantially encircles the bait and holds the bait and holds or assists in holding the bait on the hook or hook connectors.

Illustrative example of subject matter classified in this group.

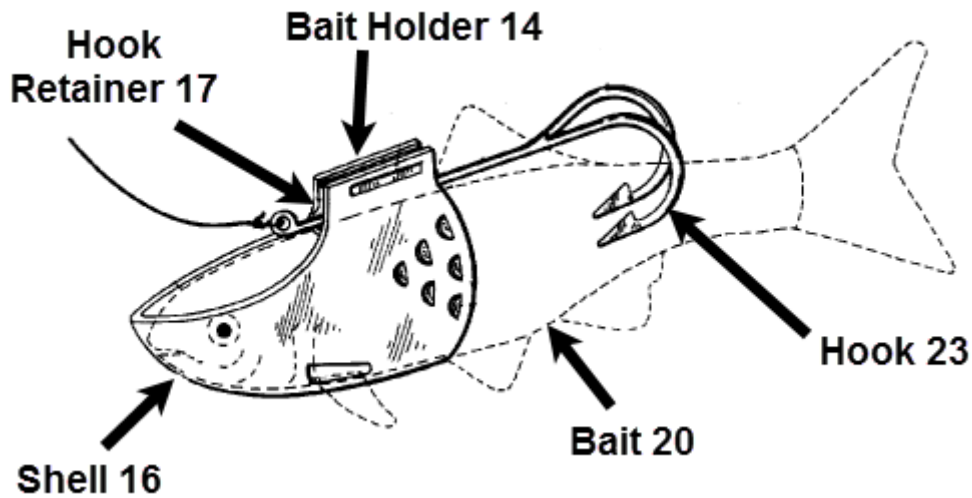

Bait holder 14 has shell 16 and hook retainer 17 for connecting the bait holder 14 to hook 23, wherein the shell 16 substantially encircles the bait 20 and holds the bait on the hook 23.

## **A01K 83/063**

### **Definition statement**

*This place covers:*

Bait holders and retainers comprising separable members which receive the bait between them and which are either resiliently biased to closing position clasp the bait or are held in closed relationship by a latch, slide, or other equivalent device.

Illustrative example of subject matter classified in this group.

DATE: FEBRUARY 1, 2022

PROJECT RP0258

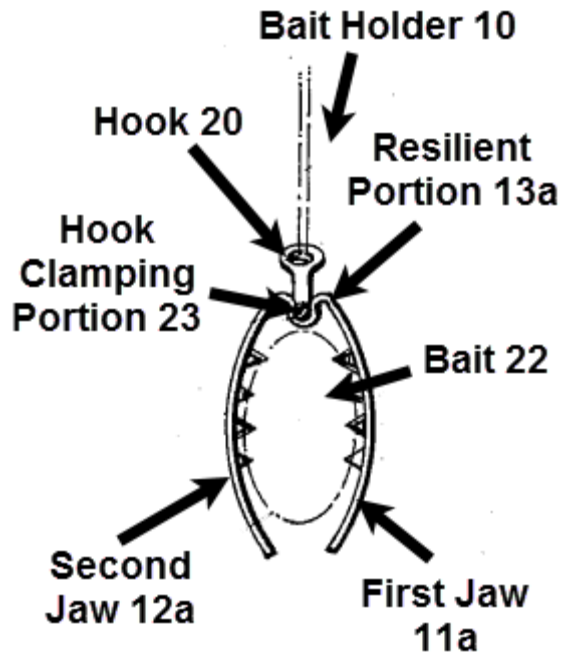

Bait holder 10 has a first jaw 11a, a second jaw 12a, a resilient portion 13a, and a hook clamping portion 23 for connecting the bait holder 10 to hook 20, wherein the first and second jaws 11a, 12a are biased toward a closing position by resilient portion 13a to receive and hold bait placed between the first and second jaws 11a, 12a.

## **A01K 83/064**

### **Definition statement**

*This place covers:*

Bait holders and retainers comprising a hook which has bait retaining means integral therewith or movably or rigidly mounted thereon, said means usually consisting of a movable hook opposing member, a clasp, a prong, point, or second hook, and the bait having no other support except the fishhook.

Illustrative example of subject matter classified in this group.

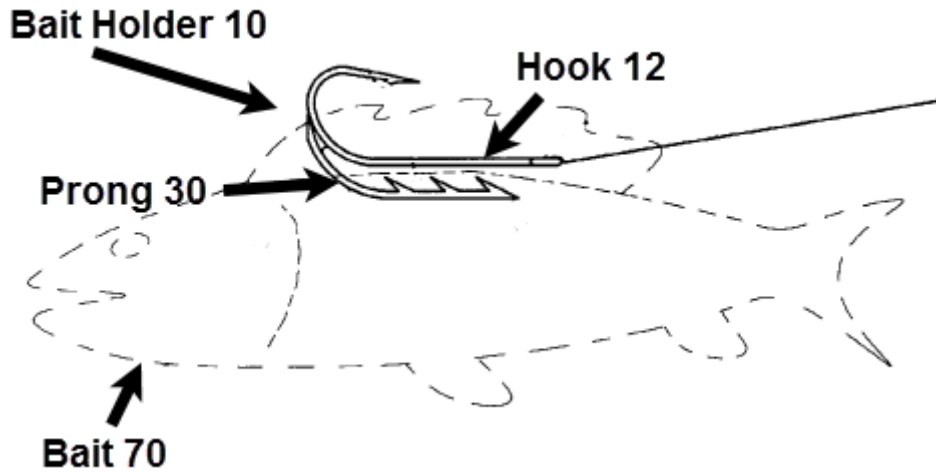

Bait holder 10 has a hook 12 and a prong 30 rigidly mounted on the hook 12, wherein the prong 30 retains bait 70.

## **A01K 83/066**

### **Definition statement**

*This place covers:*

Fishing hooks with means and arrangements guarding against the catching or snagging of weeds, marine plant growth, submerged logs, etc., constituted, for example, by single and multiple wire elements preceding or adjacent to the hooks and arrangements of multiple hooks to guard each other.

Illustrative example of subject matter classified in this group.

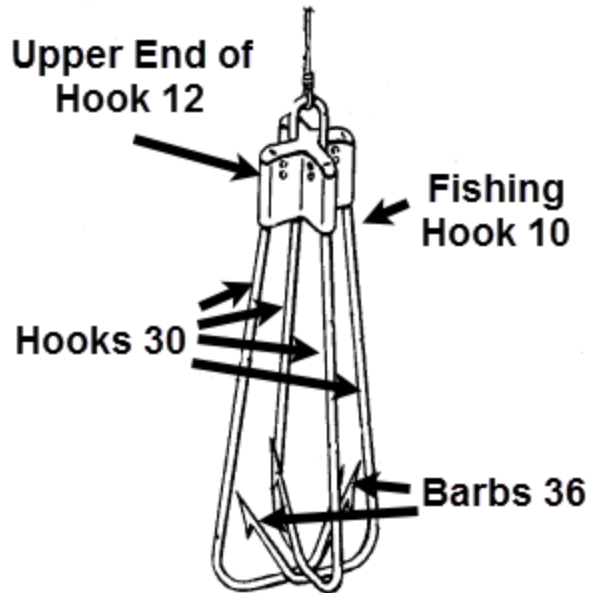

Fishing hook 10 has multiple hooks 30 arranged to guard against snagging by shielding barbs 36 at the lower ends of the hooks 30 with upper ends 12 of the hooks 30.

## **A01K 83/067**

### **Definition statement**

*This place covers:*

Fishing hooks with weed guarding means (1) constituted by an elastic, collapsible element extending from the shank of the hook to cover the hook point; (2) having a shiftable connection between the guard and the hook allowing them to slide relative to each other on a strike of a fish, or (3) having means whereby the pull on the line operates to shift the guard.

Illustrative example of subject matter classified in this group.

DATE: FEBRUARY 1, 2022

PROJECT RP0258

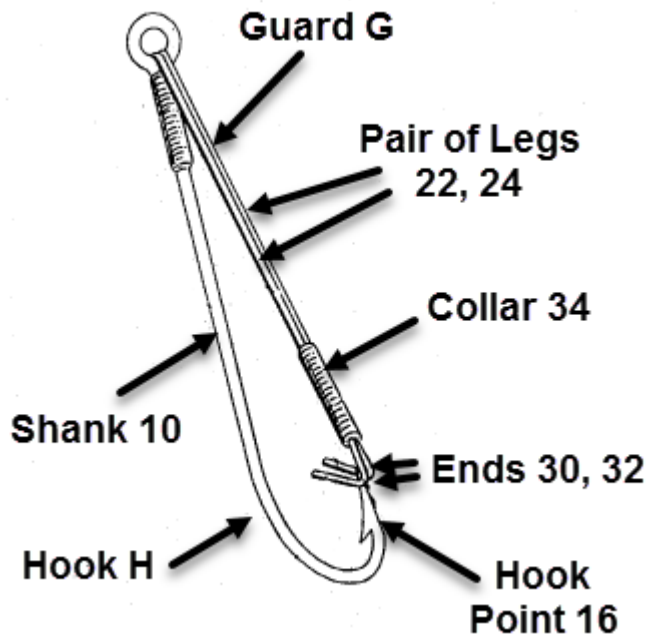

Fishing hook H has a shank 10 and a hook point 16 and a guard G has a pair of legs 22,24 with a collar 34 used to secure ends 30,32 of the legs 21,22 in close spaced relation for releasably engaging the hook point 16 so as to form a shiftable connection between the hook H and the guard G, wherein when an inwardly directed force is applied to the guard G toward the shank 10, such as by a striking fish, it results in the ends 30,32 of the legs 21,22 becoming disengaged from the hook point 16 to thus expose the hook point 16 for hooking the fish.

DATE: FEBRUARY 1, 2022

PROJECT RP0258

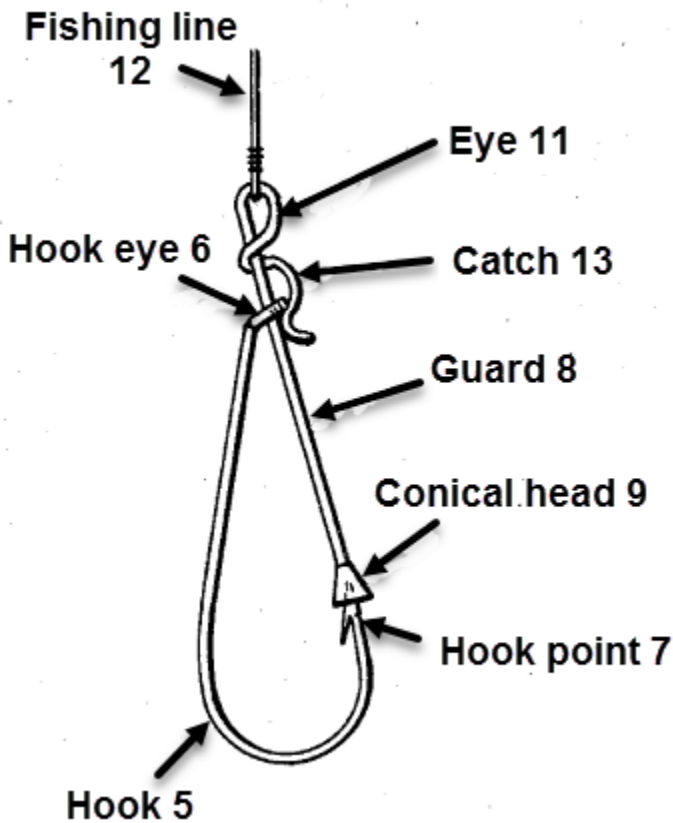

Fishing hook 5 has a hook eye 6 and a hook point 7 and a guard 8 has a conical head 9, a recess 10 for accommodating the hook point 7, an eye 11, and a catch 13, the conical head 9 covers the hook point 7 in a first position and exposes the hook point 7 in a second position for hooking a fish, the catch 13 maintains the conical head 9 in the first position by engaging the hook eye 6, and a fishing line 12 is connected to the eye 11 so that when tension is applied to the fishing line 12 it will result in disengaging the catch 13 from the hook 6 to allow the conical head 9 to move to the second position.

## A01K 83/069

### Definition statement

*This place covers:*

Fishing hooks which are guarded against the snagging of weeds, etc., by a single wire or similar element extending from adjacent the shank of the hook to substantially cover or close the point of the hook.

Illustrative example of subject matter classified in this group.



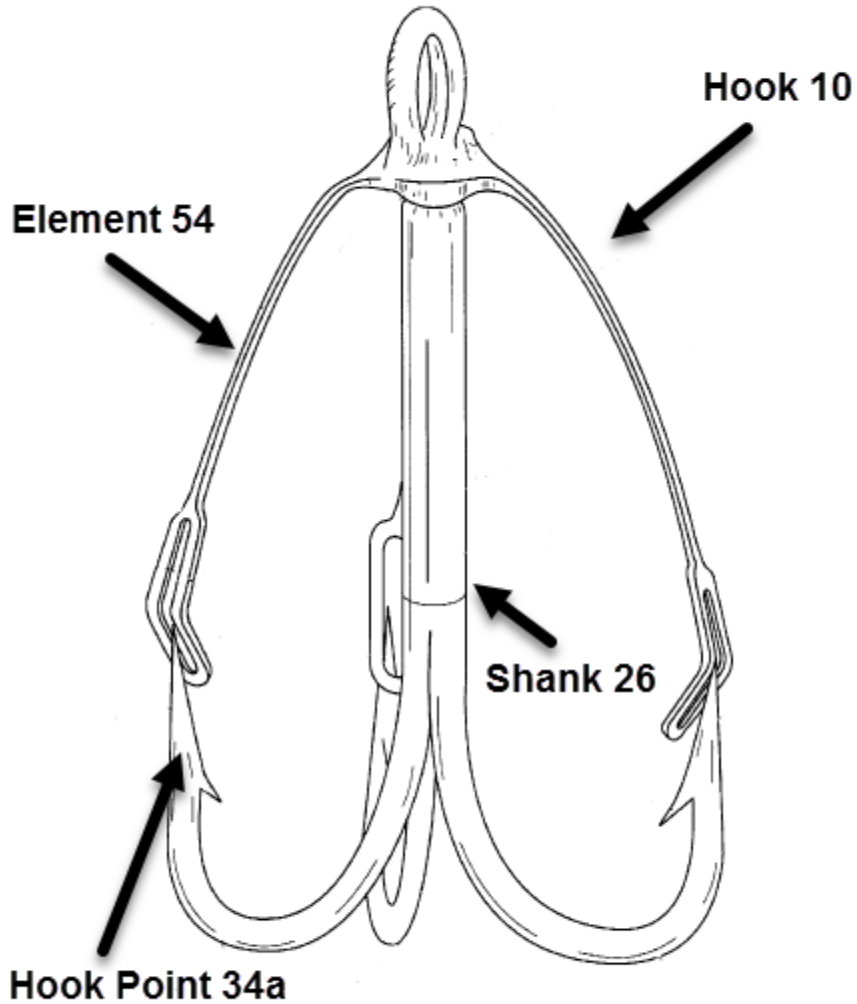

Fishing hook 10 has an element 54 extending from adjacent the shank 26 of the hook to substantially cover the point 34a of the hook.

## **A01K 85/011**

### **Definition statement**

*This place covers:*

DATE: FEBRUARY 1, 2022

PROJECT RP0258

Lures constructed with a special surface or established in various ways for the attraction of fish. Features other than or in addition to the basic subject matter of the group, which comprises a lure body, whether solid, hollow or of sheet material, hook and/or line connections, guards and weights, are included here; e.g., rigid projections such as eyes, feelers, ears, legs, etc., real or artificial skins covering bait bodies, and other surfaces simulating scales etc., reflectors, which are not merely polished lure members, but special materials as wire mesh or shells, and multiple layer effects. Coatings are included only if they cover a reflector or pattern or form a patterned effect.

Illustrative example of subject matter classified in this group.

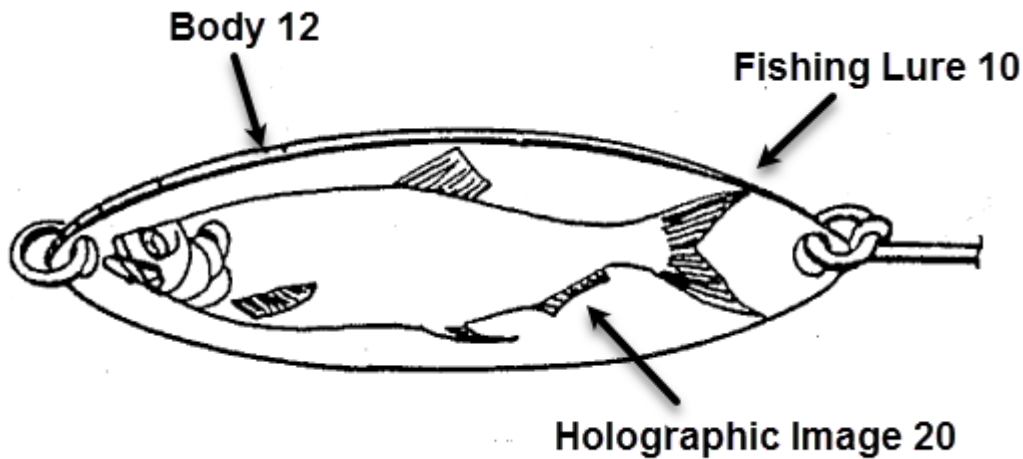

Fishing lure 10 has a body 12 with a holographic image 20 applied to the body.

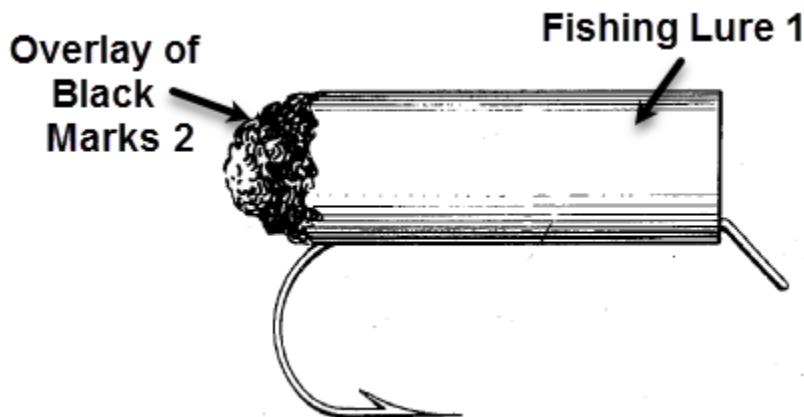

Fishing lure 1 simulating a cigarette butt is painted white from end to end with an overlay of black marks 2 simulating the ash end of the butt.

## A01K 85/012

### Definition statement

*This place covers:*

Lures with a special attracting body or body surface formed by either a transparent coating over an attracting surface or a body made of transparent or translucent material with a backing of reflecting material or patterned to give an attractive effect.

Illustrative example of subject matter classified in this group.

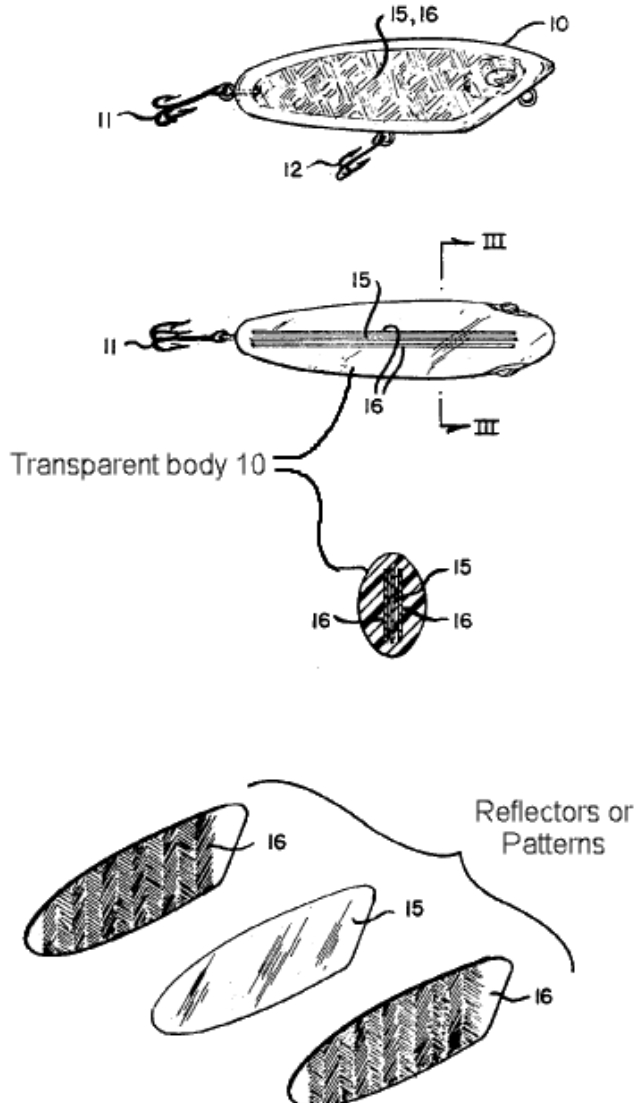

DATE: FEBRUARY 1, 2022

PROJECT RP0258

Fishing lure having body 10, (with hooks 11,12) of transparent plastic material with a backing of reflecting material comprising a central birefringent layer 15 comprising cellophane and two polarizing films 16 on each side of the central birefringent layer 15, the central birefringent layer 15 and two polarizing films 16 providing an iridescent flash to attract fish.

## A01K 85/013

### Definition statement

*This place covers:*

Lures having a body (1) formed with a pitted, roughened, ridged, etc., surface, for attracting fish, usually by imitating the skin of a fish or other live bait or by reflecting light, or (2) provided with indentations or projecting members which may be reflectors or simulations of eyes, feelers, or similar body parts.

Illustrative example of subject matter classified in this group.

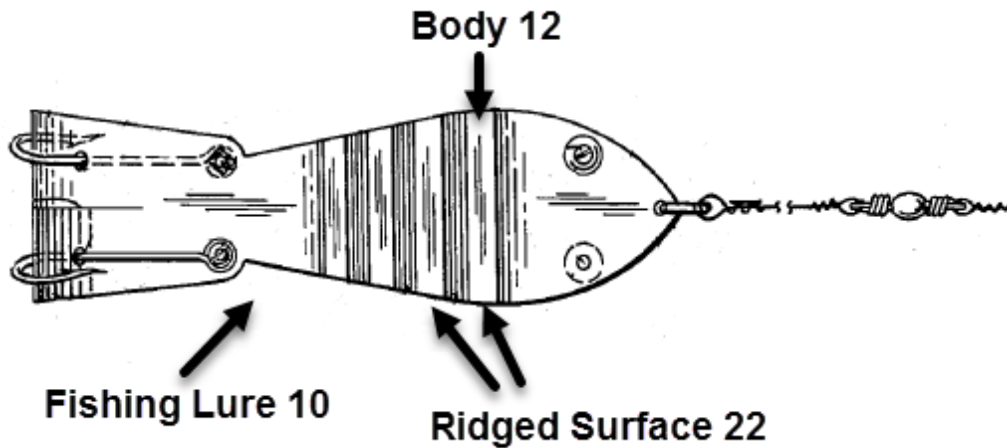

Fishing lure 10 has a body 12 with a ridged surface 22 defined by transverse corrugations for attracting fish by reflecting light.

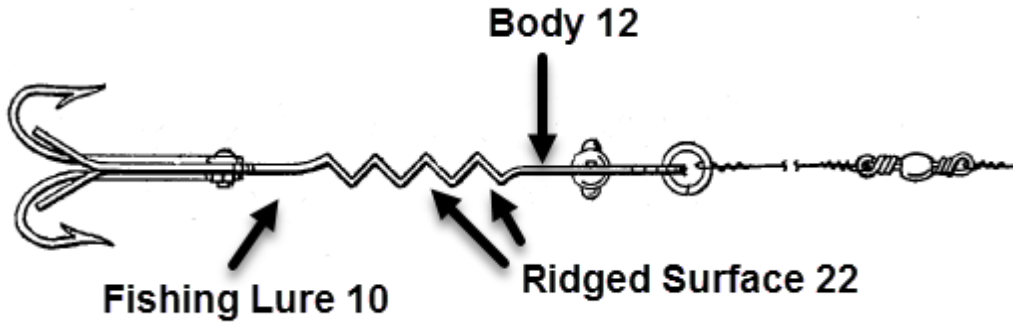

Fishing lure 10 has a body 12 with a ridged surface 22 defined by transverse corrugations for attracting fish by reflecting light.

## **A01K 85/015**

### **Definition statement**

*This place covers:*

Devices in the form of an artificial bait or lure wherein the light source is in or on the lure.

## **A01K 85/017**

### **Definition statement**

*This place covers:*

Lures having (1) means producing a noise during the passage of the bait through the water, or (2) material loosely confined on or in the body to shift during movement of the bait, usually to produce a sound effect.

## **A01K 85/018**

### **Definition statement**

*This place covers:*

Lures which give off, in their passage through the water, an attracting scent material originally contained within or on the body.

## A01K 85/019

### Definition statement

*This place covers:*

Lures having an inlet and outlet for the passage therethrough of water through which the lure is moving.

Illustrative example of subject matter classified in this group.

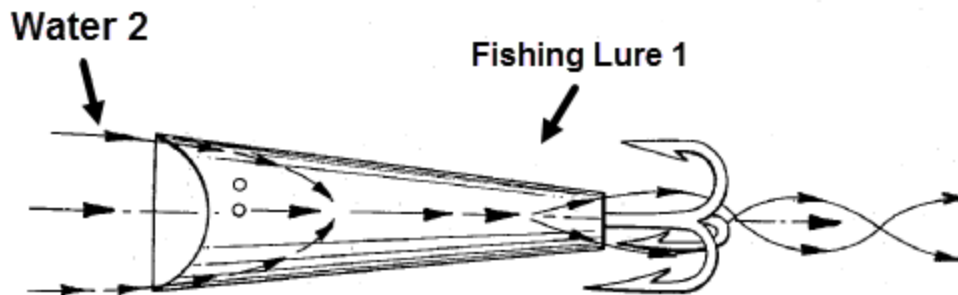

Fishing lure 1 is a hollow body which allows water 2 to flow there through.

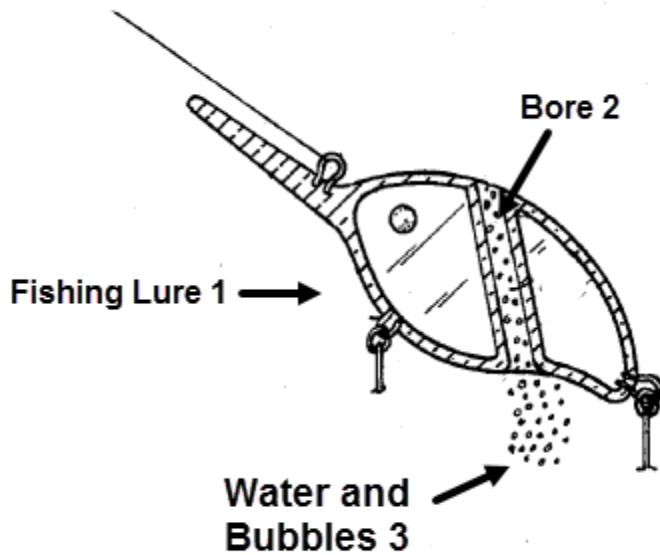

Fishing lure 1 has a bore 2 through which water and bubbles 3 will pass as the fishing lure is moved forwardly through the water.

## **A01K 85/021**

### **Definition statement**

*This place covers:*

Lures which are made of a flexible material and which either house the hook or protect it by preceding and/or shielding the hook points or barbs. The bait is compressible or collapsible to allow fish to take the hook.

Illustrative example of subject matter classified in this group.

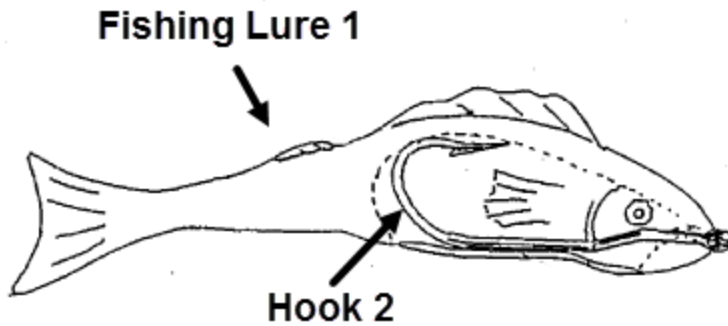

Fishing lure 1 is made from a flexible material and houses the hook 2.

## **A01K 85/022**

### **Definition statement**

*This place covers:*

Lures with means or arrangements for guarding the body or the hook or both, against the catching or snagging of weeds, marine plant growth, submerged logs, or for non-use, constituted either by multiple hooks arranged to guard each other or by the relation of the lure body to the hook or by wire or other projecting or opposed elements protecting the lure body, hook or hook points.

## **A01K 85/023**

### **Definition statement**

*This place covers:*

Ridge lures with a weed guard element for the attached hooks constructed so the hook or hook point is guarded by being housed within or located adjacent to a slot or depression in a lure body. The hooks are either loosely or flexibly attached so they can impale the fish upon its strike.

Illustrative example of subject matter classified in this group.



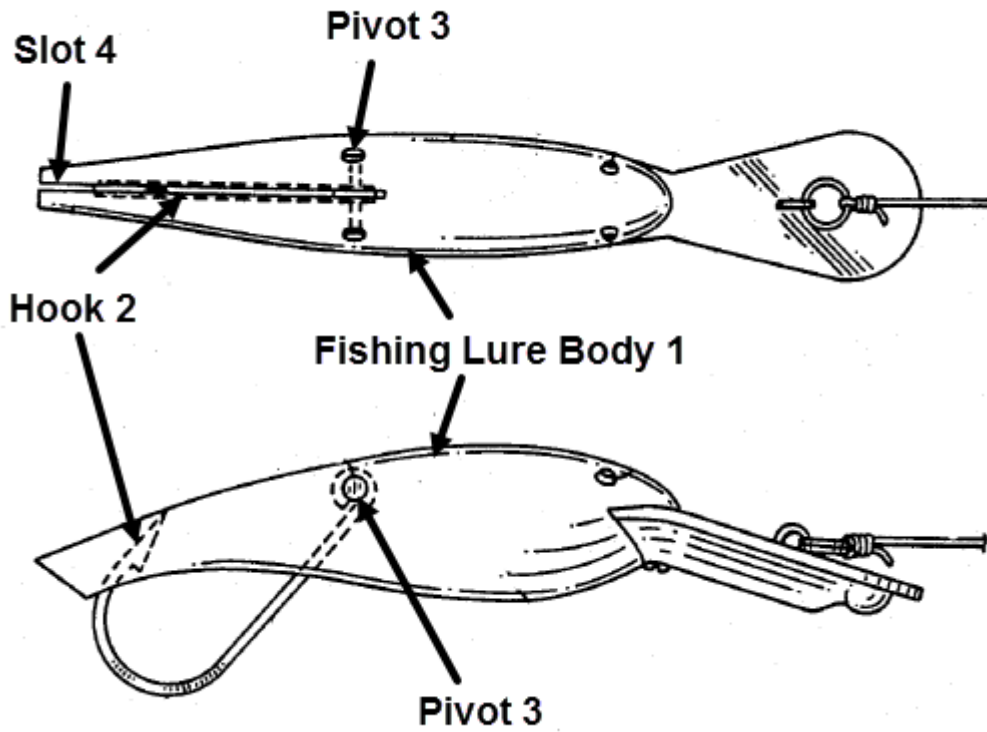

Fishing lure body 1 has a hook 2 which is loosely attached at pivot 3, wherein the hook 2 is guarded by being housed within a slot 4 in the fishing lure body 1.

## **A01K 85/024**

### **Definition statement**

*This place covers:*

Lures with weed guard elements projecting outwardly from the lure body to guard the hooks or body and hooks against vegetation or fend the lures from obstructions.

Illustrative example of subject matter classified in this group.

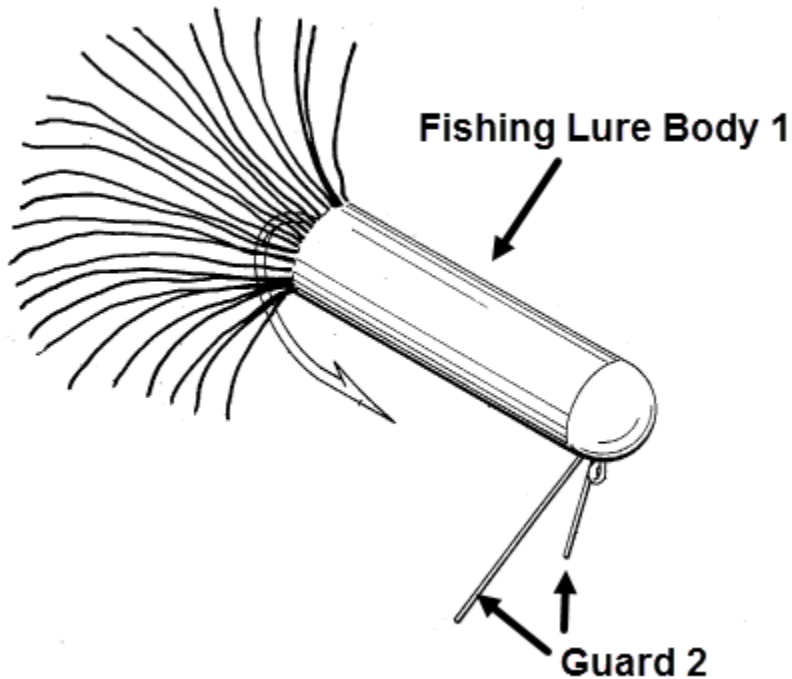

Fishing lure body 1 has a guard 2 projecting outwardly from the lure body 1.

## **A01K 85/025**

### **Definition statement**

*This place covers:*

Lures, with weed guards formed by elements projecting from a point forward of the hook point, and which substantially close or cover the point of the hook.

Illustrative example of subject matter classified in this group.

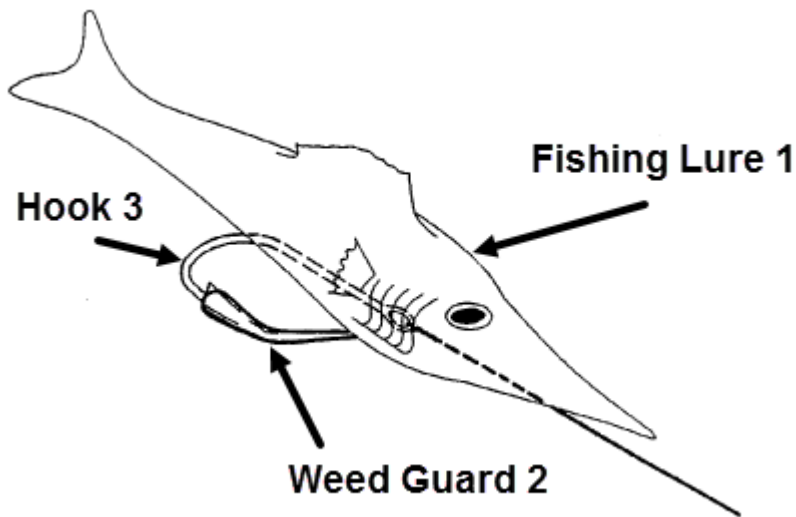

Fishing lure 1 has a weed guard 2 that projects from a point forward of the point of a hook 3 so as to substantially close or cover the point of the hook 3.

## **A01K 85/026**

### **Definition statement**

*This place covers:*

Lures having at least one hook or hook-like device mounted on a base or supporting part in a non-hooking or housed position for movement relative thereto to hooking position and including means for causing the relative motion. The motion causing means may comprise hooks biased to operative position and having catch or other releasable means holding the hook in inoperative position.

## **A01K 85/027**

### **Definition statement**

*This place covers:*

Lures having spring-actuated trap-hooks comprising two or more hooks normally held close together and tending to spread apart from each other to snag or catch a fish biting at the same.

Illustrative example of subject matter classified in this group.

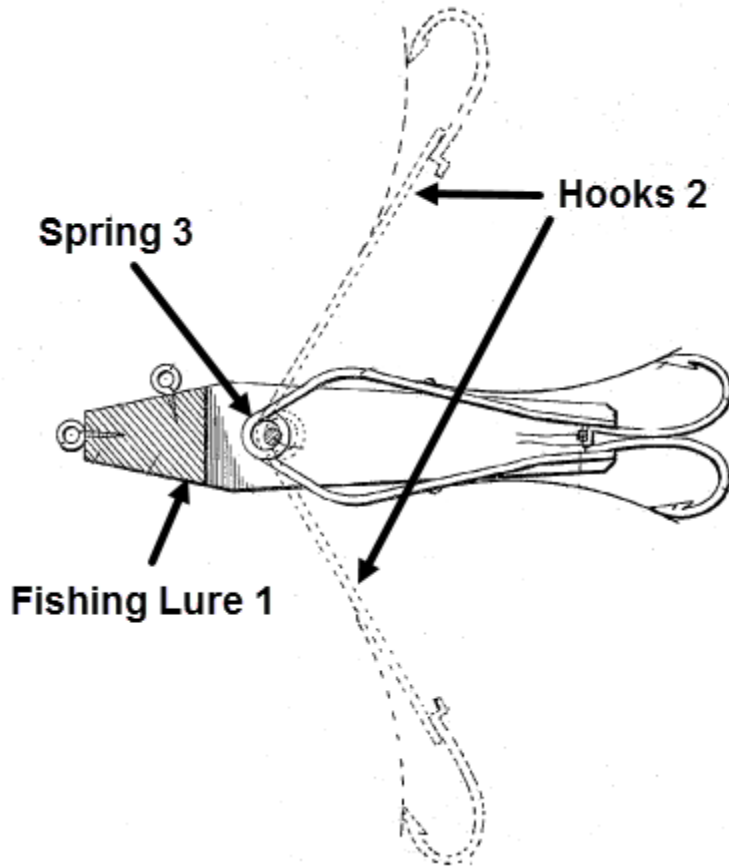

Fishing Lure 1 comprises two hooks 2 which are biased away from each other by a spring 3, wherein the hooks 2 are normally held close together as shown in the solid line position of the hooks 2 and which spread apart from each other to snag or catch a fish biting at the same time as shown in phantom line position of the hooks 2.

## **A01K 85/028**

### **Definition statement**

*This place covers:*

Fishing lures having trap-hooks actuated only by a pull, either from the fish or from the fisherman, or both, and not by a spring or weight.

Illustrative example of subject matter classified in this group.

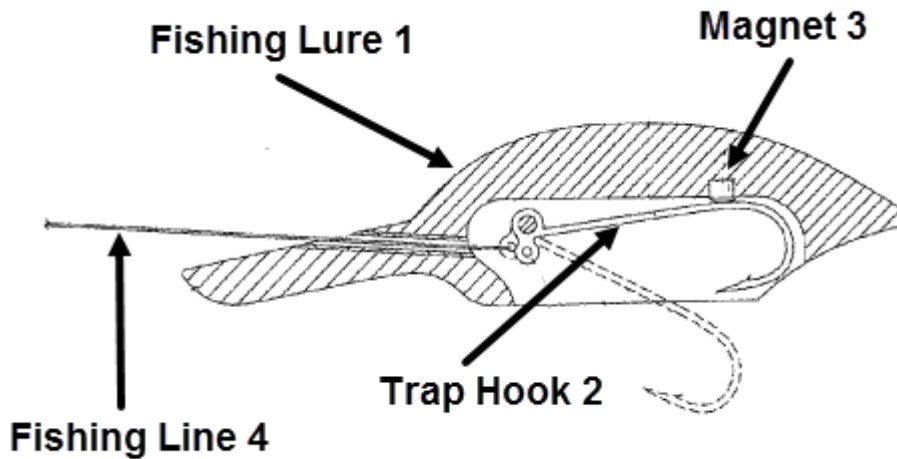

Fishing lure 1 has a trap hook 2 which is normally held inside the Fishing lure 1 by magnet 3, wherein the trap hook 2 is actuated by a pull on the fishing line 4 to cause the trap hook 2 to move externally of the fishing lure 1 to thereby hook a fish.

## **A01K 85/029**

### **Definition statement**

*This place covers:*

Lures which have interchangeable lure parts for the substitution of parts of different form, color, etc., or means permitting ready interchange of such parts. Disconnectable or shiftable body parts for the attachment of various attracting elements and bodies with multiple covers which are removable and expendable are included.

Illustrative example of subject matter classified in this group.

DATE: FEBRUARY 1, 2022

PROJECT RP0258

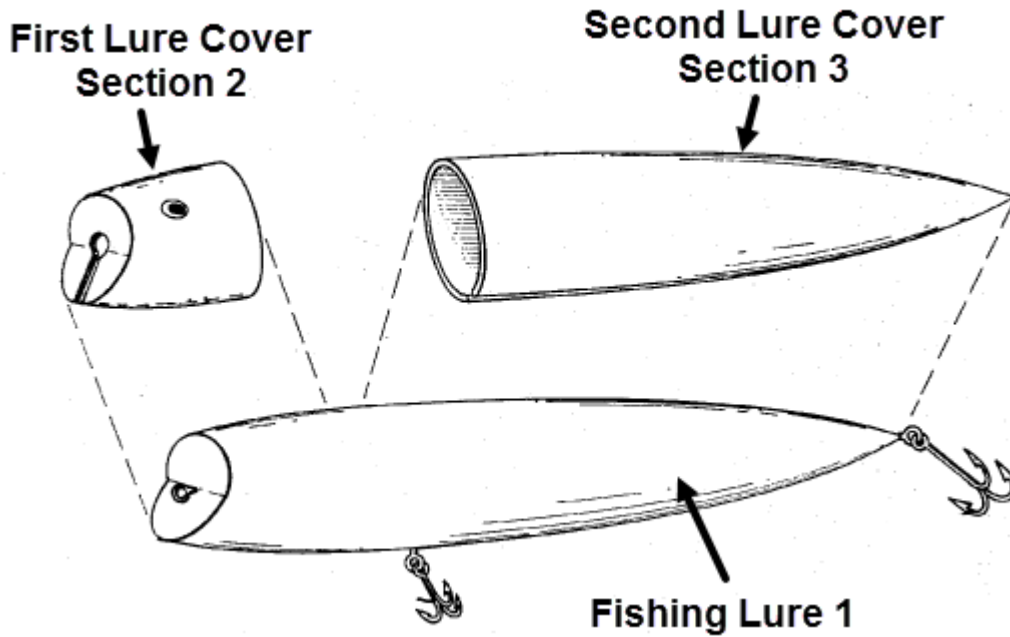

Fishing lure 1 has a first lure cover section 2 and a second lure cover section 3 which may be removably mounted on the fishing lure 1 in order to change the exterior appearance of the fishing lure 1 by exchanging various cover sections having different colors or appearances.

DATE: FEBRUARY 1, 2022

PROJECT RP0258

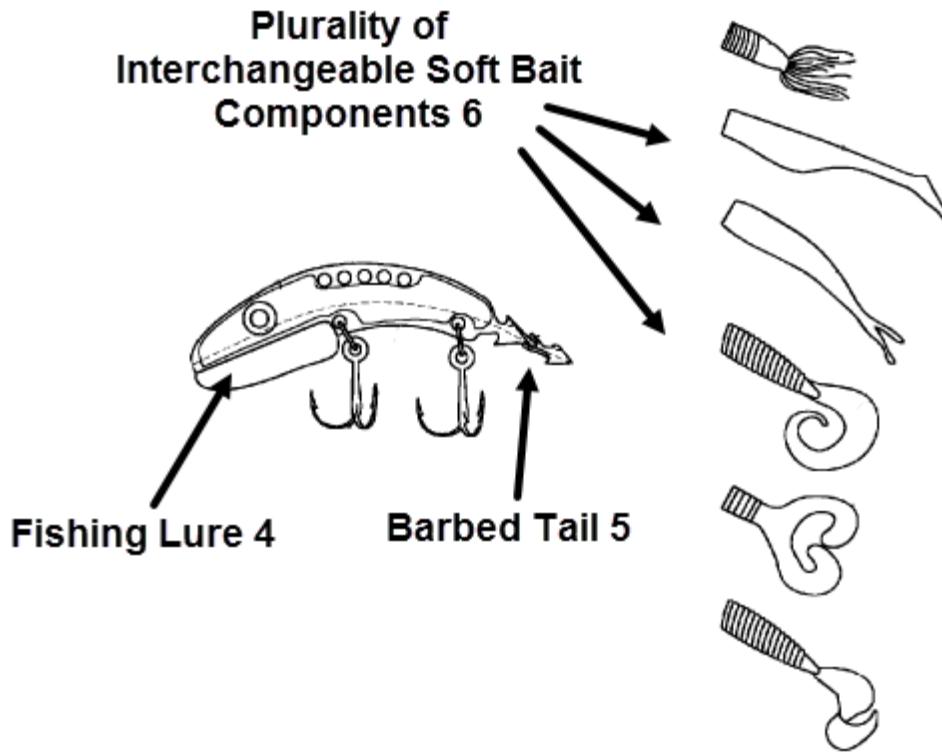

Fishing lure 4 has a barbed tail 5 to which any one of a plurality of interchangeable soft bait components 6 may be attached to in order to change the appearance of the fishing lure 4.

## A01K 85/122

### Definition statement

*This place covers:*

Lures having rotating bodies of vane type whose cross-section forms an area rather than a line when viewed perpendicularly to the axis of rotation.

Illustrative example of subject matter classified in this group.

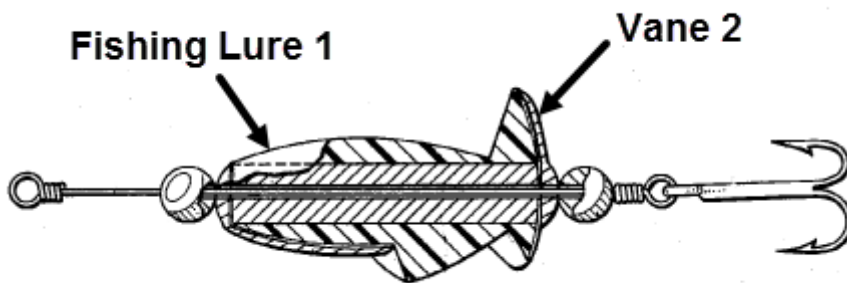

Fishing lure 1 comprises a rotating body 2 of vane type having a cross-section which forms an area rather than a line when viewed perpendicularly to the axis of rotation.

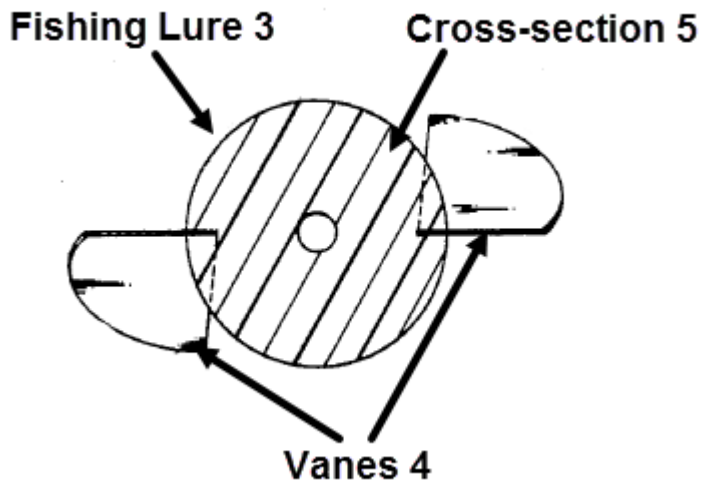

Fishing lure 3 comprises a rotating body with vanes 4 and which has a cross-section which forms an area rather than a line when viewed perpendicularly to the axis of rotation.



## A01K 85/125

### Definition statement

*This place covers:*

Lures having rotating bodies of vane type whose cross-section forms a line rather than an area when viewed perpendicularly to the axis of rotation.

Illustrative example of subject matter classified in this group.

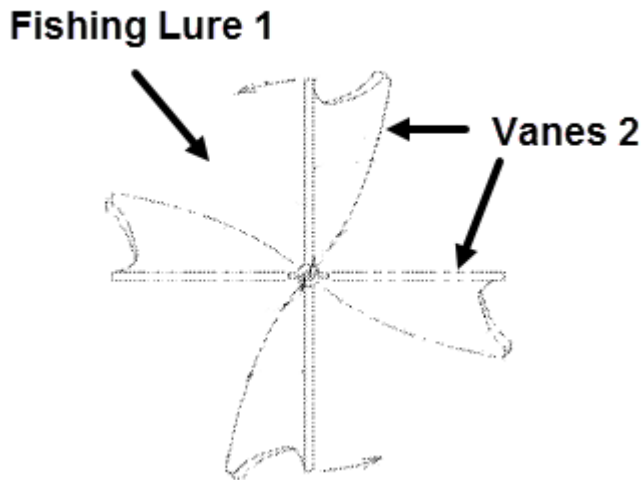

Fishing lure 1 comprises a rotating body with vanes 2, wherein the fishing lure 1 has a cross-section which forms a line rather than an area when viewed perpendicularly to the axis of rotation.

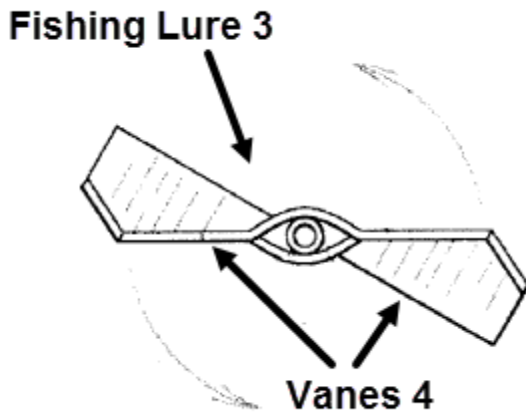

Fishing lure 3 comprises a rotating body with vanes 4, wherein the fishing lure 3 has a cross-section which forms a line rather than an area when viewed perpendicularly to the axis of rotation.

## **A01K 85/128**

### **Definition statement**

*This place covers:*

Lures in which the body is caused to rotate either by vanes or blades turned oppositely thereon or by reason of the spiral shape of the body.

Illustrative example of subject matter classified in this group.

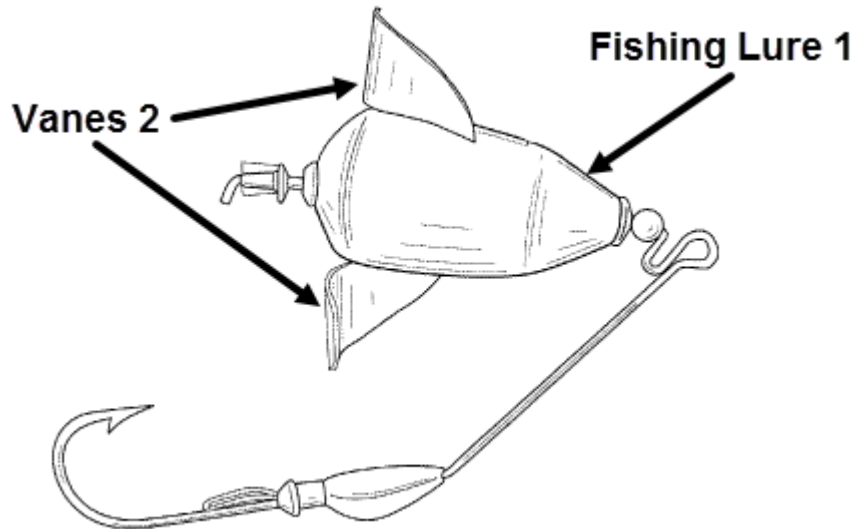

Fishing lure 1 comprises a rotating body with vanes 2 that are turned oppositely thereon.

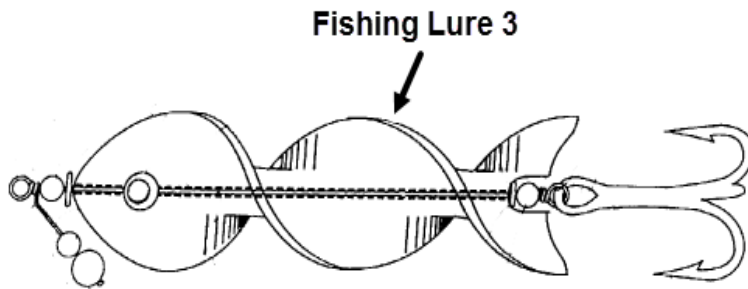

Fishing lure 3 comprises a rotating body with a spiral shape.

## **A01K 85/143**

### **Definition statement**

*This place covers:*

Lures with flat, or substantially flat, undulating bodies with spiral or oppositely directed vanes that are non-rotatable with respect to the lure bodies.

Illustrative example of subject matter classified in this group.

DATE: FEBRUARY 1, 2022

PROJECT RP0258

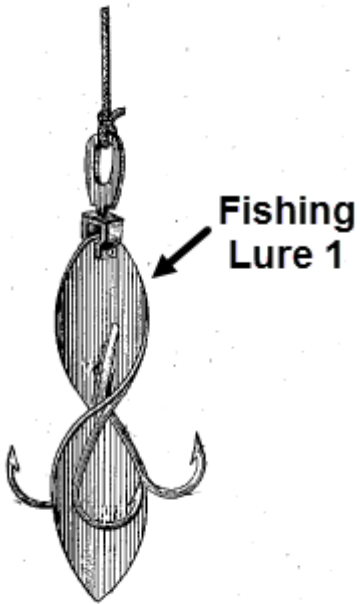

Fishing lure 1 has a spiral shape.

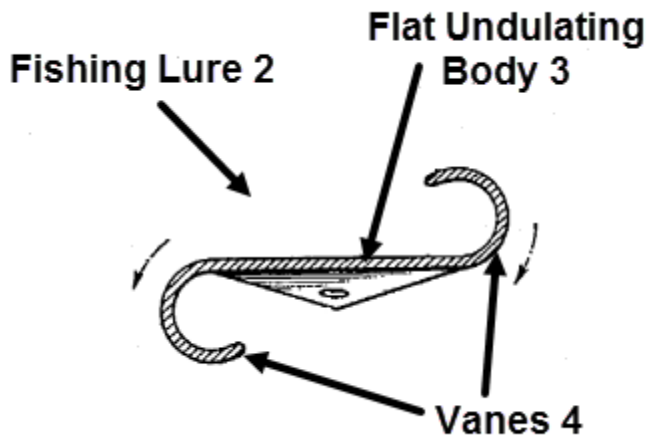

Fishing lure 2 comprises a flat undulating body 3 with oppositely directed vanes 4.

## A01K 85/147

### Definition statement

*This place covers:*

Lures in which the hook or hooks are attached rigidly or for non-pivoted movement, or in which the hook or hooks are attached at a point inward from the margin of the spoon.

Illustrative example of subject matter classified in this group.

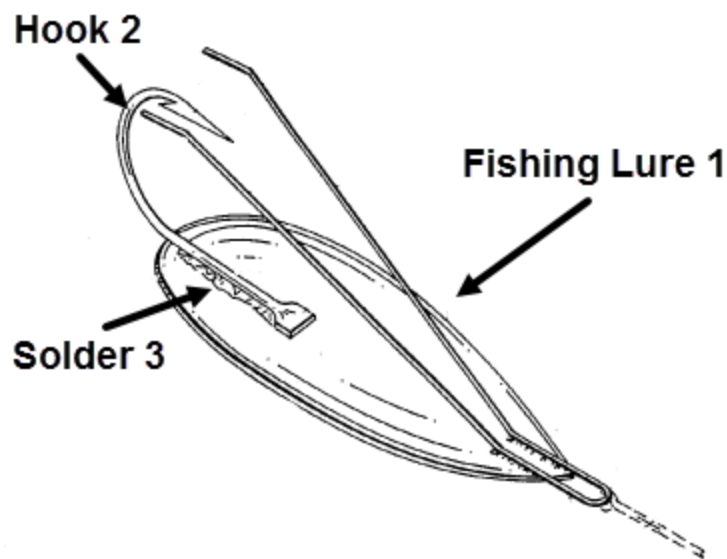

Fishing lure 1 has a hook 2 which is rigidly attached by solder 3.

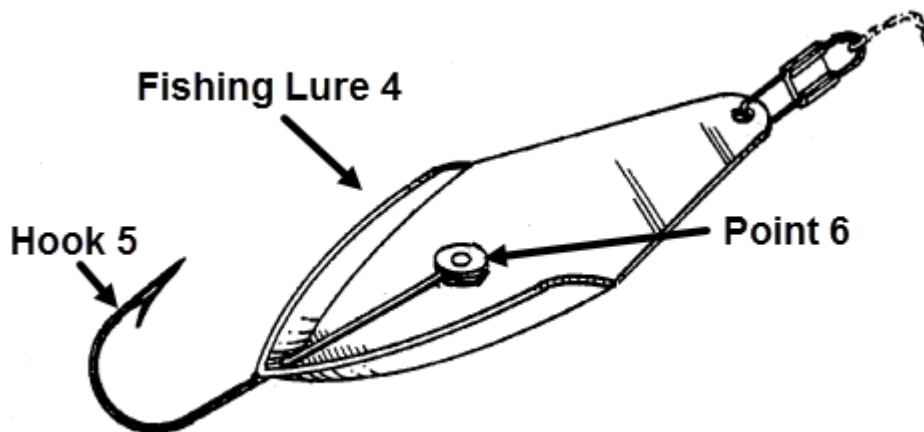

Fishing lure 4 is a spoon which has a hook 5 which is rigidly attached at a point 6 inward from the margin of the spoon.

## A01K 85/1803

### Definition statement

*This place covers:*

Lures in which the body has rigidly attached sheet material plates or diving vanes or lips for diving, guiding, etc.

Illustrative example of subject matter classified in this group.

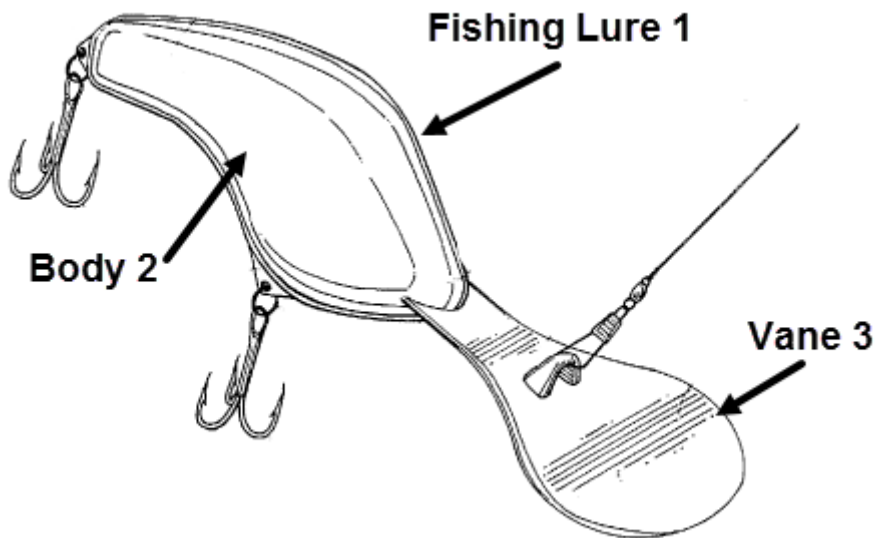

Fishing lure 1 comprises a body 2 having a rigidly attached vane 3 for causing the fishing lure 1 to dive when retrieved.

## A01K 85/1807

### Definition statement

*This place covers:*

Lures having vanes, bodies or body parts operated by continuous movement through the water to swing or flex from side to side by the pressure of the water on them each time the lure changes its direction, causing the lure to turn immediately in the opposite direction, the lure being thereby given a wobbling motion. The directing member may

DATE: FEBRUARY 1, 2022

PROJECT RP0258

be either a pivotally connected vane or a flat member pivotally mounted at or near its ends so that the center part is flexed back and forth.

Illustrative example of subject matter classified in this group.

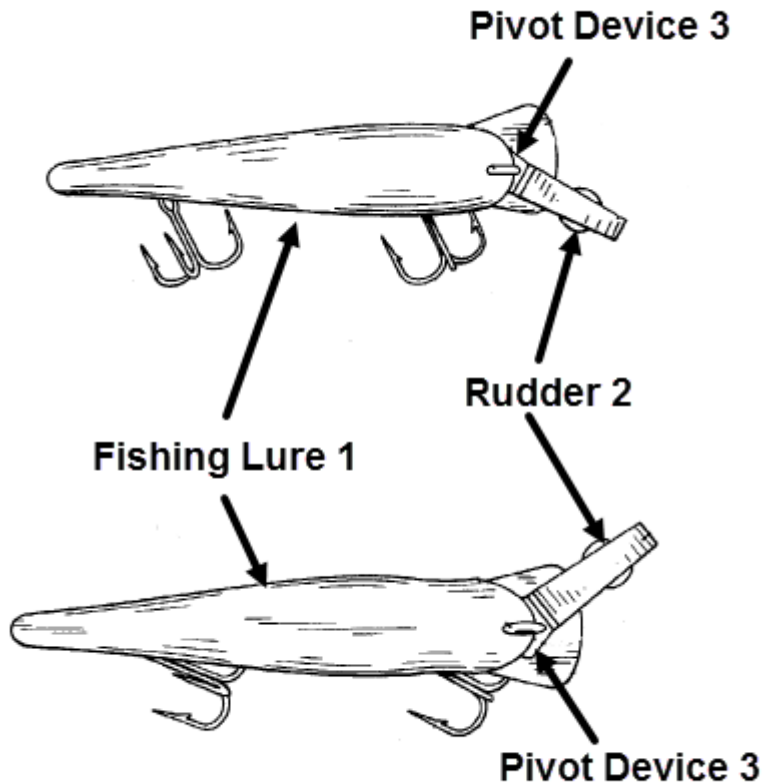

Fishing lure 1 has a rudder 2 which is connected to the body of the fishing lure 1 by a pivot device 3, wherein the rudder 2 is operated by continuous movement through the water to swing from side to side by the pressure of the water on the rudder 2 which causes the fishing lure 1 to turn in opposing directions.

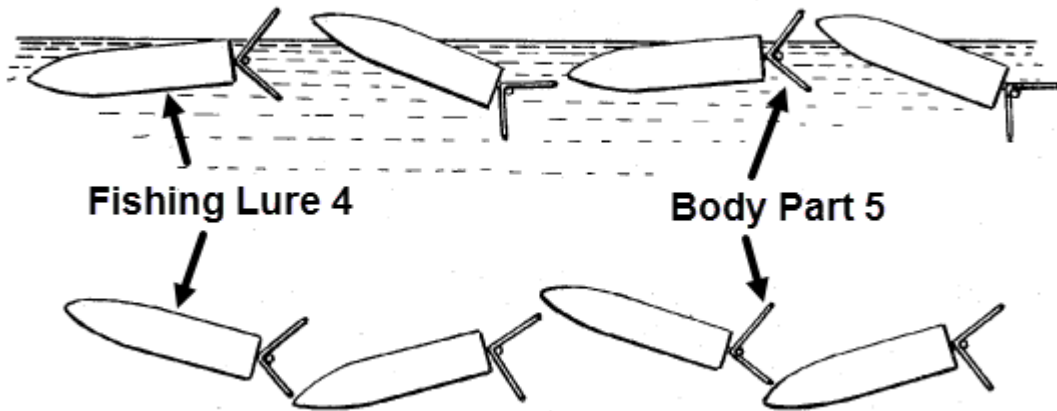

Fishing lure 4 has a body part 5 that is pivotally connected to the body of the fishing lure 4, wherein the body part 5 is operated by continuous movement through the water to swing or flex from side to side by the pressure of the water on the body part 5 each time the fishing lure 4 changes its direction, causing the fishing lure 4 to turn immediately in the opposite direction to thereby give a wobbling motion.

## **A01K 85/1811**

### **Definition statement**

*This place covers:*

Lures in which either the entire body or a body appendage is made of a flexible material.

## **A01K 85/1813**

### **Definition statement**

*This place covers:*

Lures comprising a body with plural flexible elements or appendages attached intermediate its ends.

Illustrative example of subject matter classified in this group.



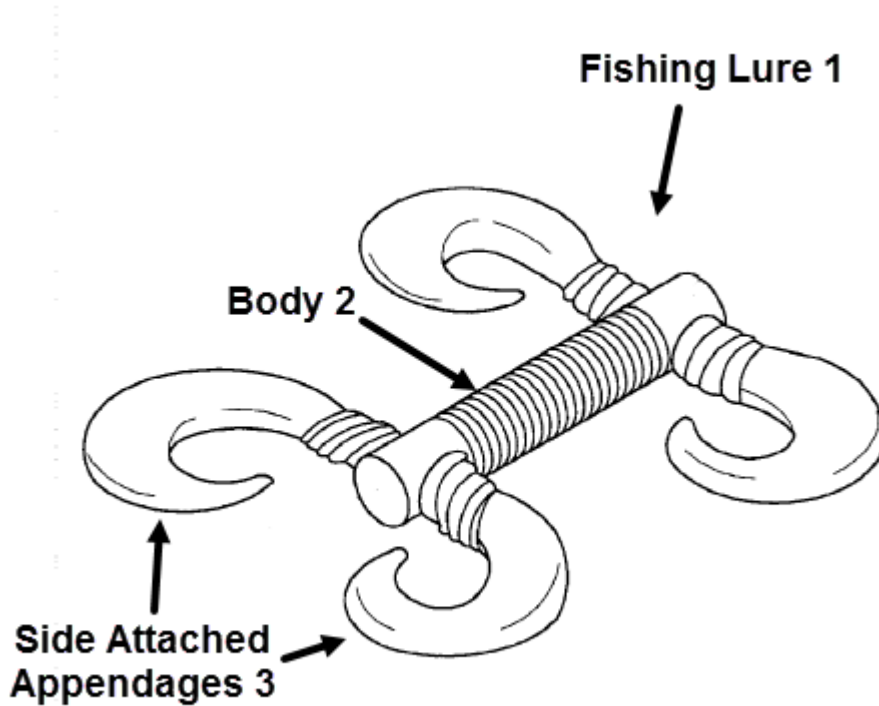

Fishing lure 1 comprises a body 2 with plural flexible side attached appendages 3 attached intermediate the ends of the fishing lure 1.

## **A01K 85/1817**

### **Definition statement**

*This place covers:*

Lures comprising a body with plural flexible elements or appendages attached intermediate its ends which are for simulating wings.

Illustrative example of subject matter classified in this group.

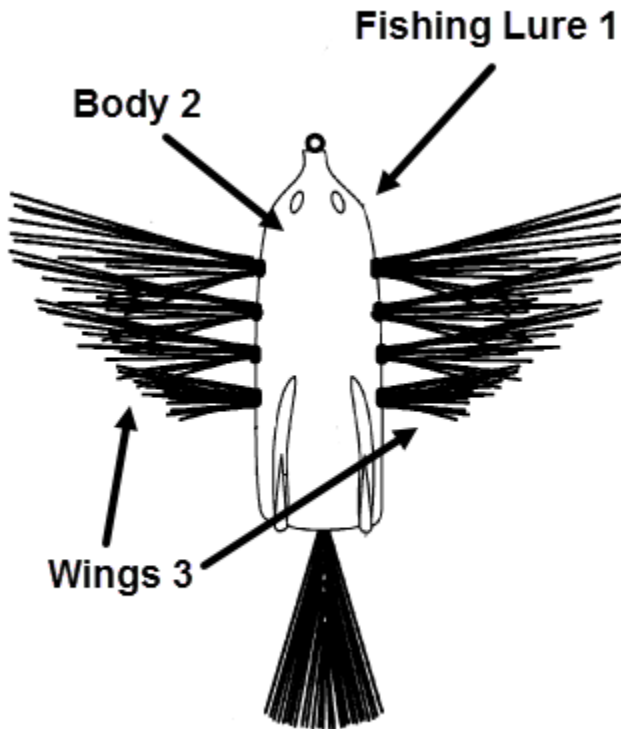

Fishing lure 1 comprises a body 2 with plural side attached appendages which simulate wings 3.

## **A01K 85/1821**

### **Definition statement**

*This place covers:*

Lures comprising a body having one or more elongated members of flexible material at or near its rear end to be trailed rearwardly in its passage through the water.

Illustrative example of subject matter classified in this group.

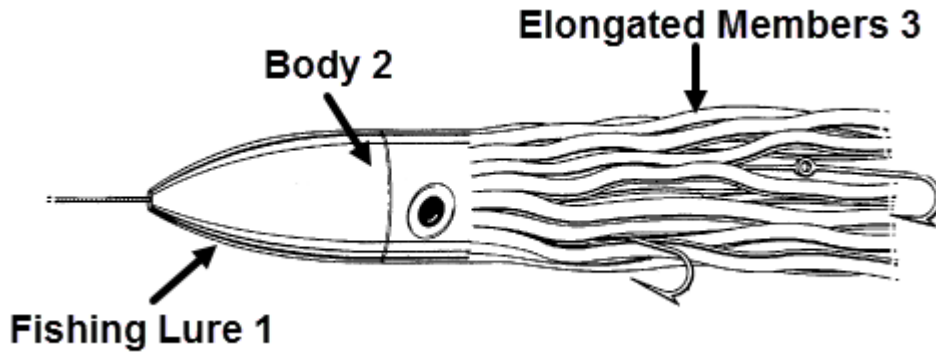

Fishing lure 1 comprises a body 2 with elongated members 3 of flexible material at its rear end to be trailed rearwardly in its passage through the water.

## A01K 85/1823

### Definition statement

*This place covers:*

Lures, having trailing appendages in the form of detachable, flexible strips of material, such as a pork rind.

Illustrative example of subject matter classified in this group.

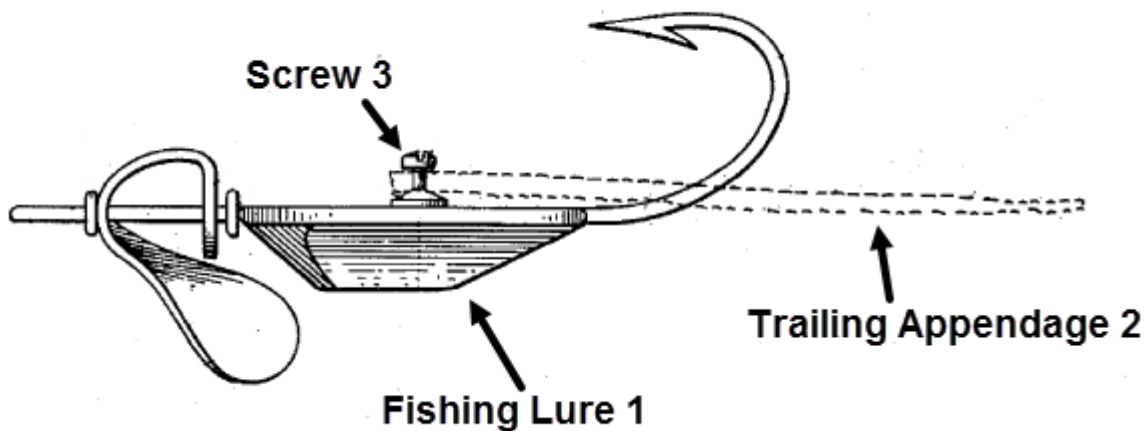

Fishing lure 1 comprises a trailing appendage 2 which is detachable from the fishing lure 1 via a screw 3.

## A01K 85/1827

### Definition statement

*This place covers:*

Lures comprising a body with two flexible, trailing appendages, usually simulating a frog.

Illustrative example of subject matter classified in this group.

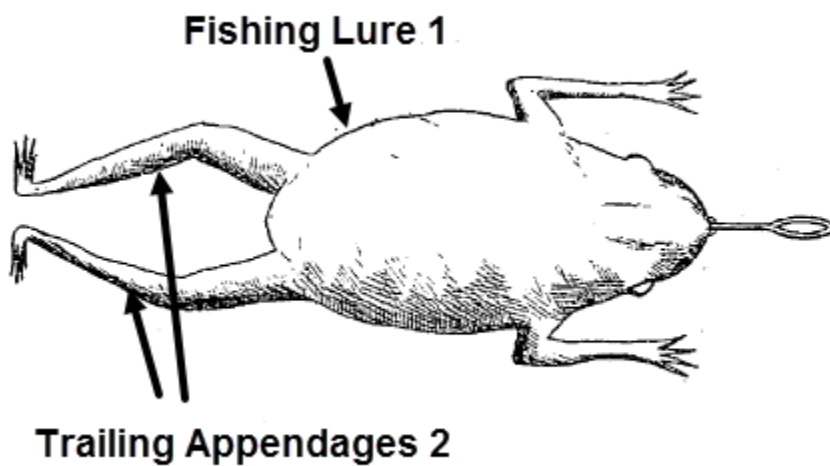

Fishing lure 1 comprises two trailing appendages 2 so as to simulate a frog.

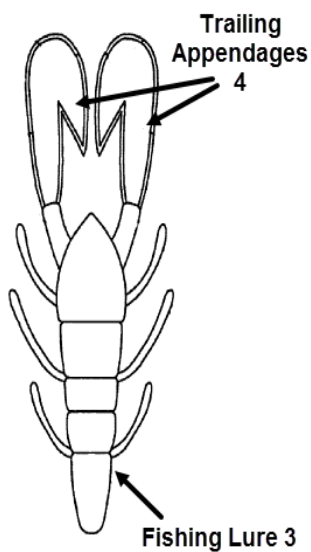

Fishing lure 3 comprises two trailing appendages 4 which simulate a crayfish.

## A01K 85/1831

### Definition statement

*This place covers:*

Lures formed by a body mounted solely on a hook, the hook being directly connected to the line or to a leader connected to the line.

Illustrative example of subject matter classified in this group.

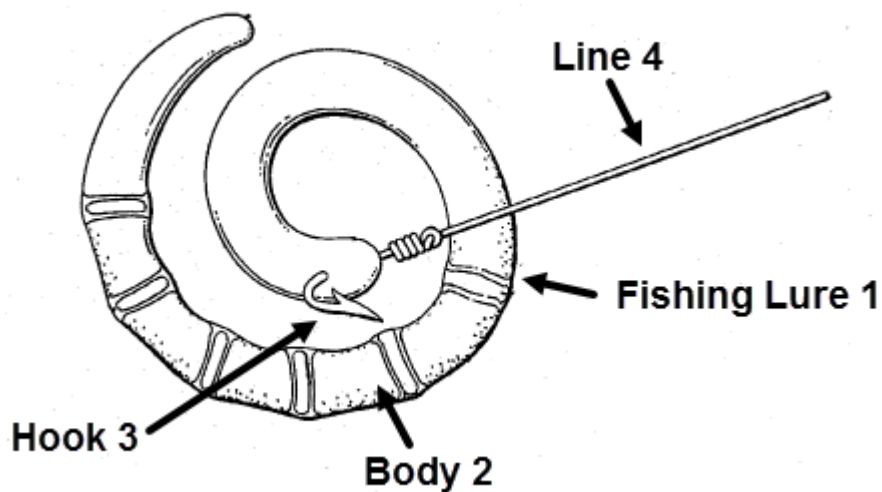

Fishing lure 1 comprises a body 2 mounted solely on a hook 3 which is directly connectable to the line 4.

## A01K 85/1833

### Definition statement

*This place covers:*

Lures comprising a fish hook with a weighting mass molded or formed about a portion of the hook, usually at the forward end of the fish hook.

Illustrative example of subject matter classified in this group.

DATE: FEBRUARY 1, 2022

PROJECT RP0258

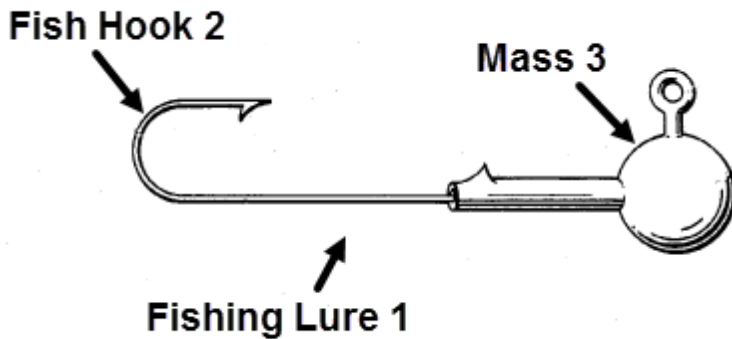

Fishing lure 1 comprises a fish hook 2 with a mass 3 molded or formed about a forward portion of the fish hook 2.

## A01K 85/1837

### Definition statement

*This place covers:*

Lures which have weights as components of or additions to the body of the lure, for reasons such as balance, diving, etc.

Illustrative example of subject matter classified in this group.

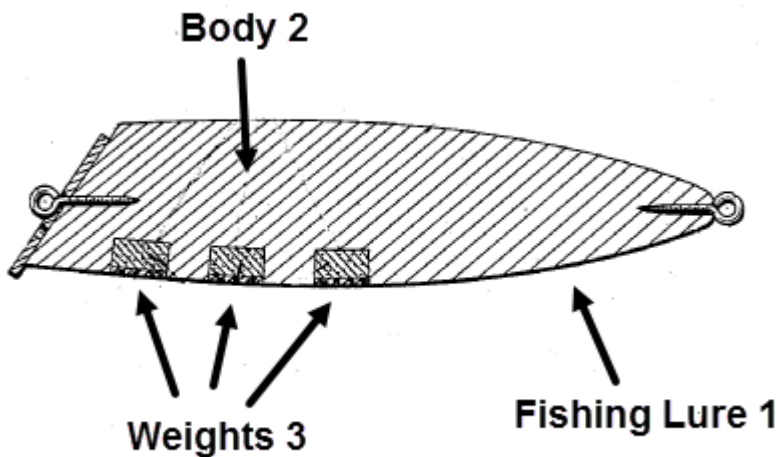

DATE: FEBRUARY 1, 2022

PROJECT RP0258

Fishing lure 1 comprises a body 2 having weights 3 placed along an underside of the body 2 so as to balance the fishing lure 1 in an upright orientation during use and to increase the overall weight of the fishing lure 1 so as to cause the fishing lure 1 to dive to deeper depths.

## A01K 85/1841

### Definition statement

*This place covers:*

Lures with directing parts, buoyancy devices or line connections adjustable to vary the path of the bait through the water. Diving, guiding, depth below the surface, etc., may be affected. The adjustments are made manually when the lure is not in the water. Hollow bodies containing variable weights, valved hollow bodies into which air or water may be introduced, and adjustable vanes or other directing means are included.

Illustrative example of subject matter classified in this group.

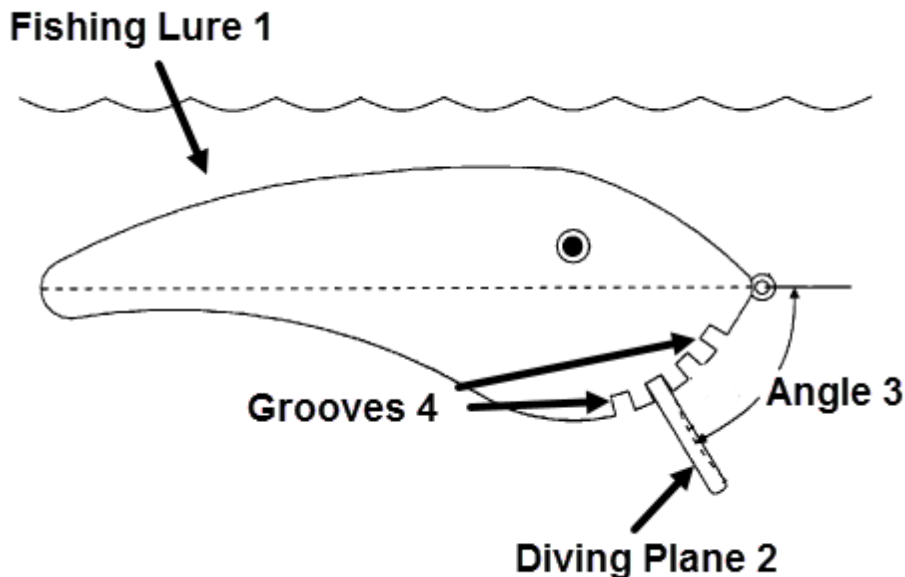

Fishing Lure 1 comprises a diving plane 2 mounted at the forward end of the fishing lure 1, wherein the angle 3 of the diving plane 2 may be adjusted by positioning the diving plane 2 within a selected one of grooves 4, resulting in the control of the depth and angle at which the fishing lure 1 will dive as it is retrieved in the water.

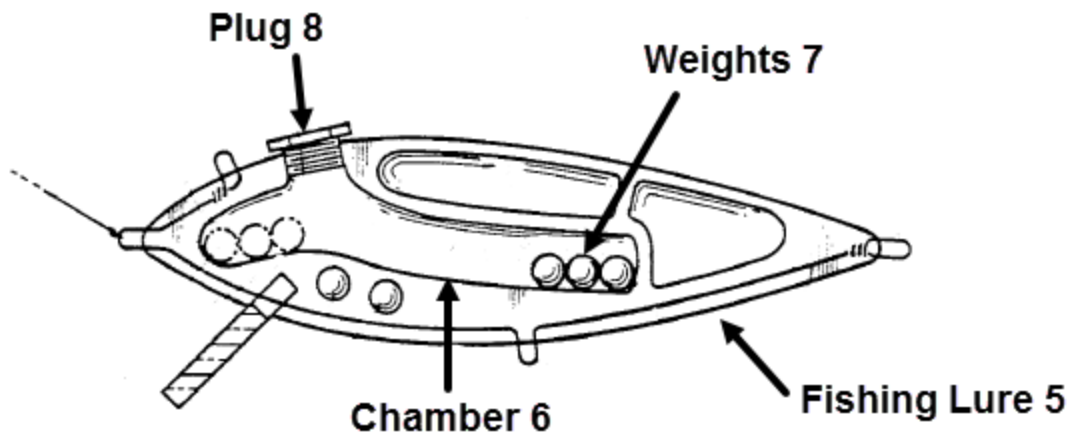

Fishing lure 5 comprises a buoyancy affecting chamber 6 which receives weights 7 for providing ballast to the fishing lure 5, wherein the chamber can be accessed by a plug 8 to allow the user to either add or remove the weights 7 from the chambers 6 to thereby adjust the overall buoyancy of the fishing lure 5.

## **A01K 85/1843**

### **Definition statement**

*This place covers:*

Lures having an adjustable connection for the line.

Illustrative example of subject matter classified in this group.



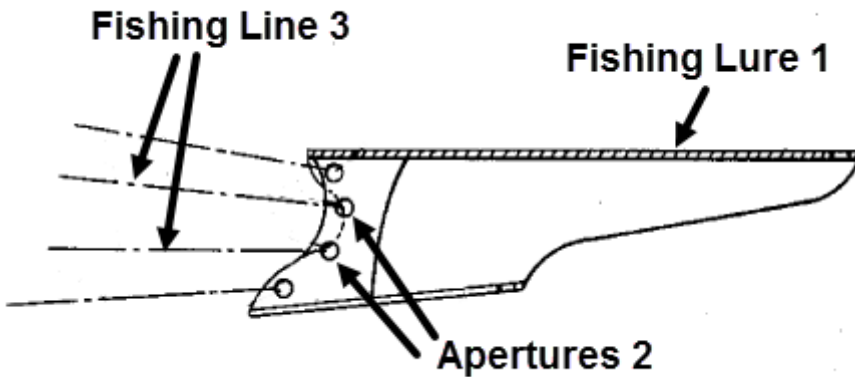

Fishing lure 1 has a plurality of apertures 2 at a forward end thereof, wherein the fishing line 3 may be selectively connected to any one of the apertures 2 so as to control the angle and depth at which the fishing lure 1 will travel as it is retrieved.

## **A01K 85/1847**

### **Definition statement**

*This place covers:*

Lures constructed with a hollow interior for various reasons, such as buoyancy, materials and methods of construction, etc.

Illustrative example of subject matter classified in this group.

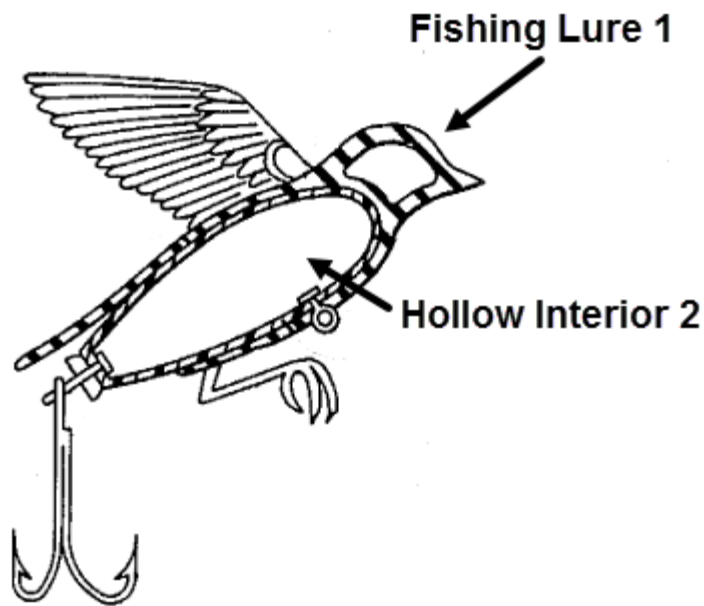

Fishing lure 1 has a hollow interior 2 for providing buoyancy to the fishing lure 1 so that it floats in water.

## **A01K 85/1851**

### **Definition statement**

*This place covers:*

Lures having a direct hook to line connection which either passes through the body of the lure or is fixedly attached along the length of the body.

Illustrative example of subject matter classified in this group.

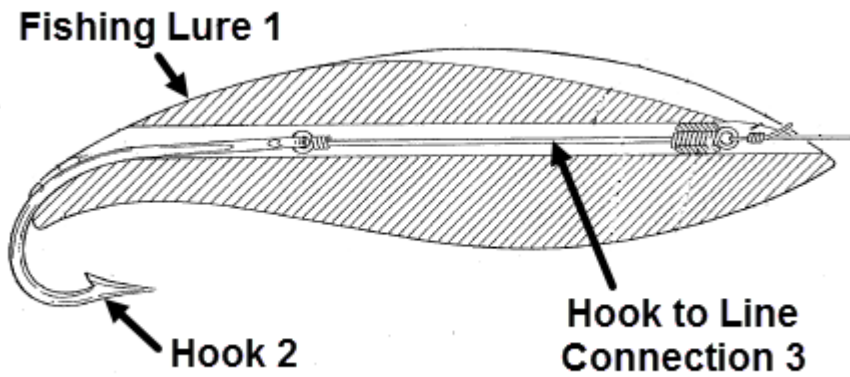

Fishing lure 1 comprises a body, a hook 2 and a direct hook to line connection 3 that passes through the body of the fishing lure 1.

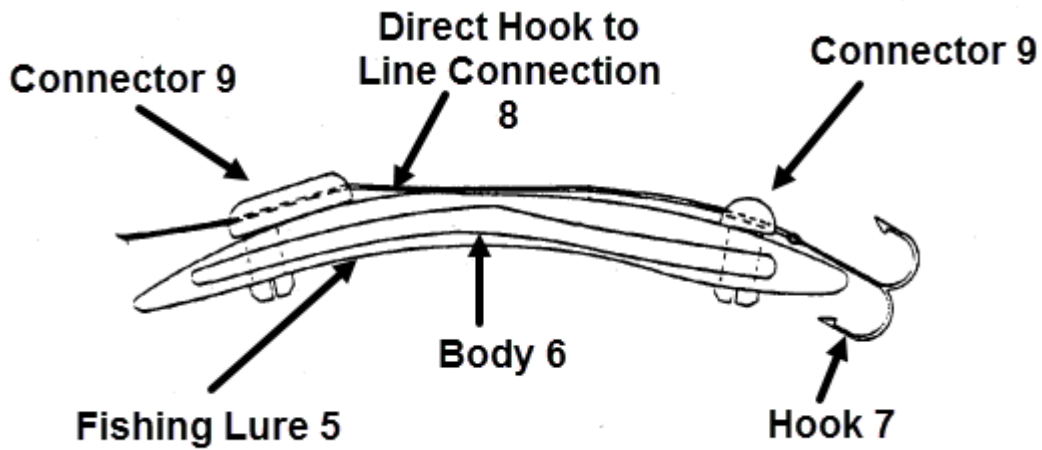

Fishing lure 5 comprises a body 6, a hook 7 and a direct hook to line connection 8 that is fixedly attached along the length of the body by connectors 9.

## A01K 85/1853

### Definition statement

*This place covers:*

Lures loosely and slidably mounted on the line or hook and line connector to allow the lure body to move away from the hook or hooks.

Illustrative example of subject matter classified in this group.

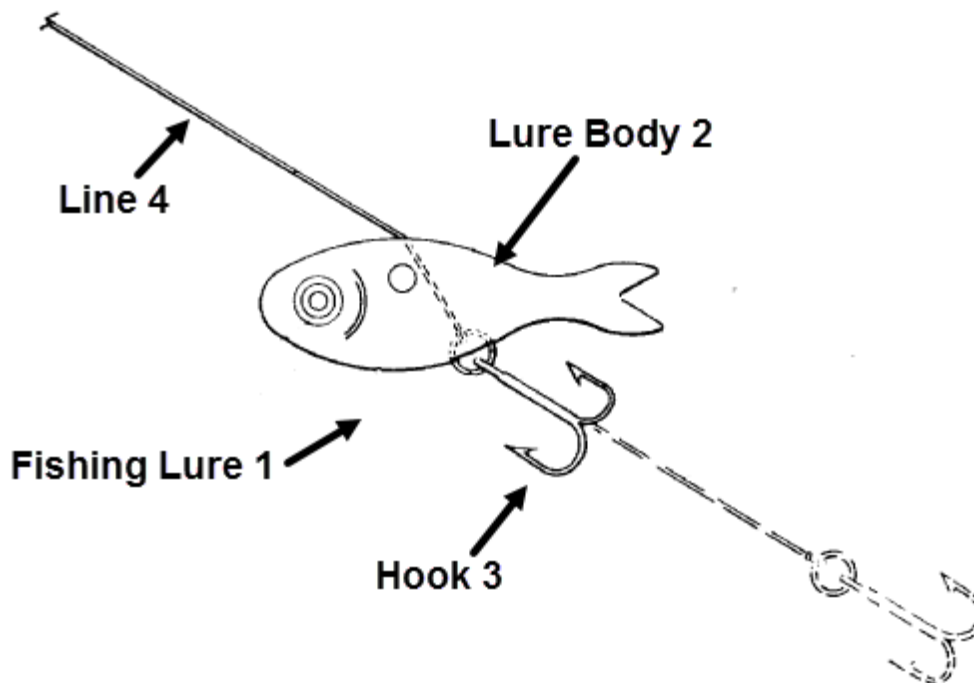

Fishing Lure 1 comprises a body 2 and a hook 3, wherein the fishing lure 1 is slidably mounted on line 4 to allow the lure body 2 to move away from the hook 3.

## A01K 85/1857

### Definition statement

*This place covers:*

Lures in which (1) the lure must be shifted relative to the hook connection to give access to the hook holding means before the hook can be disconnected, or (2) the means for holding the line on the lure and the means for holding the hook on the lure are so interrelated that one must be moved from operative position before the other can be removed or disengaged from the lure or operated to release the hook or line held by it.

Illustrative example of subject matter classified in this group.

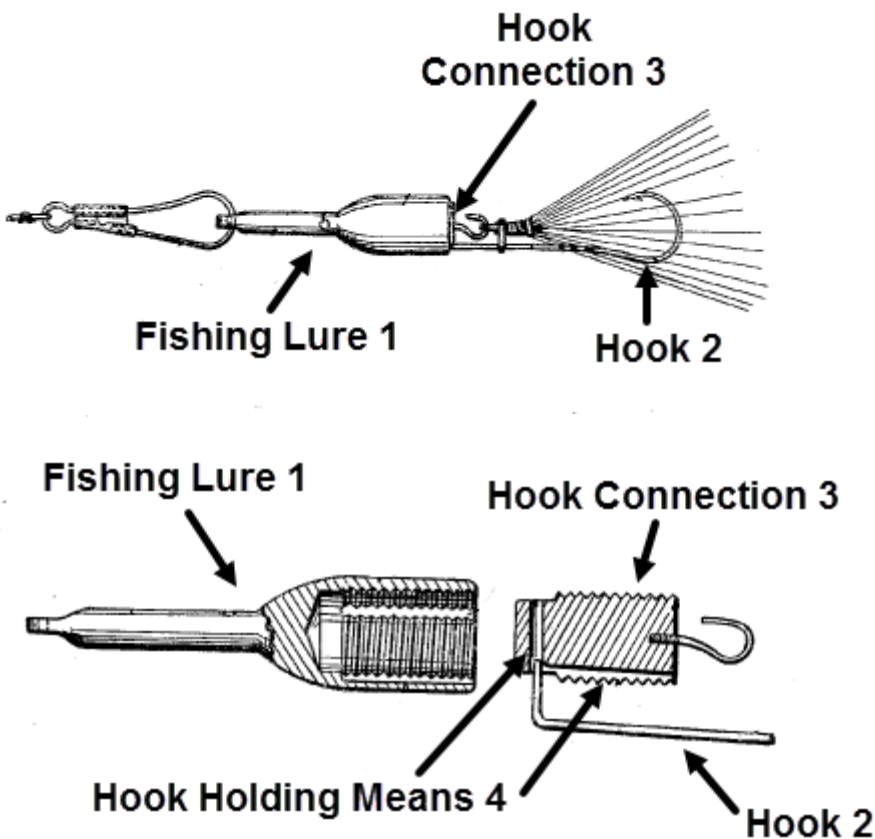

Fishing Lure 1 comprises a hook 2, a hook connection 3, and hook holding means 4, wherein the fishing lure 1 must be shifted relative to the hook connection 3 to give access to the hook holding means 4 before the hook 2 can be disconnected.

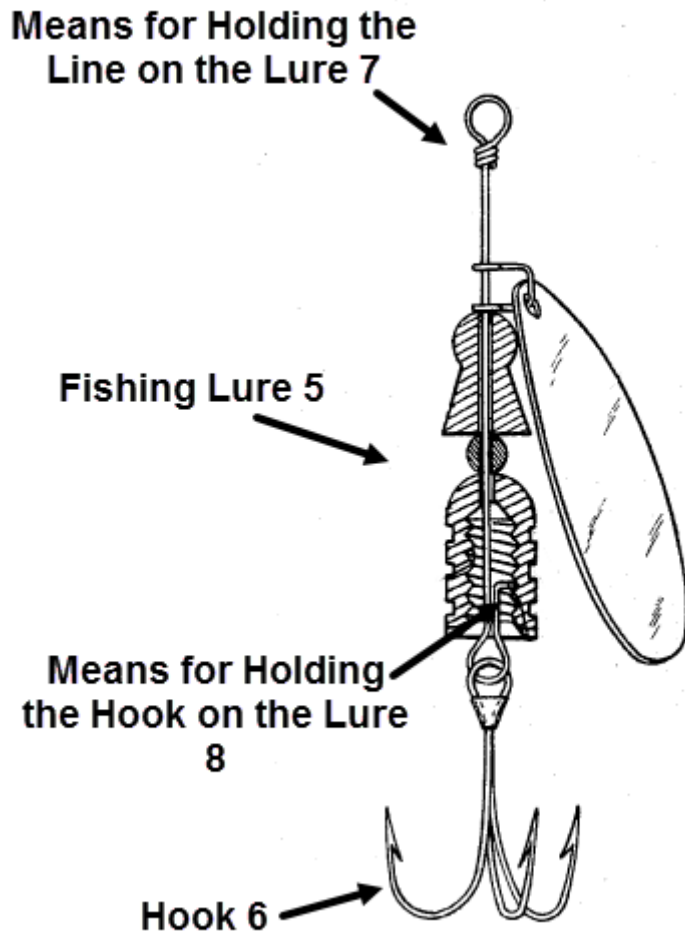

DATE: FEBRUARY 1, 2022

PROJECT RP0258

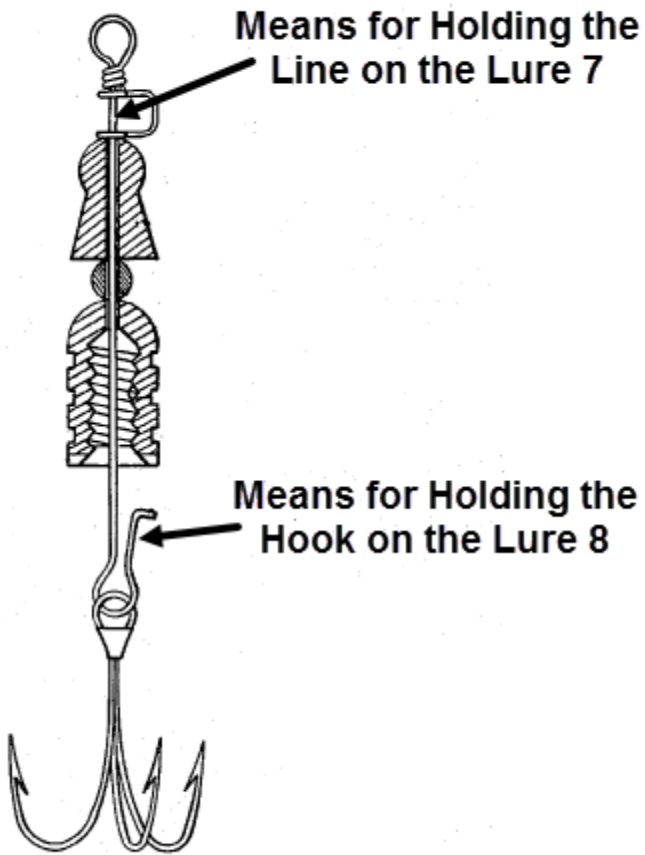

Fishing lure 5 comprises a hook 6, means for holding the line on the lure 7, and means for holding the hook on the lure 8, wherein the means for holding the line on the lure 7 must be moved downwardly from operative position before the hook 6 can be disengaged from the fishing lure 5.

## A01K 85/1861

### Definition statement

*This place covers:*

Lures with a shiftable body, body part, or hooks which are normally held in one position either by releasable detents, friction, or the pull of the line, but which are actuated and moved relative to one another upon the strike of a fish, either to free the hook from the lure or separate it enough so that the fish can be held securely. Hooks releasably held adjacent to the lure body to be shifted by the strike of a fish are included.

Illustrative example of subject matter classified in this group.

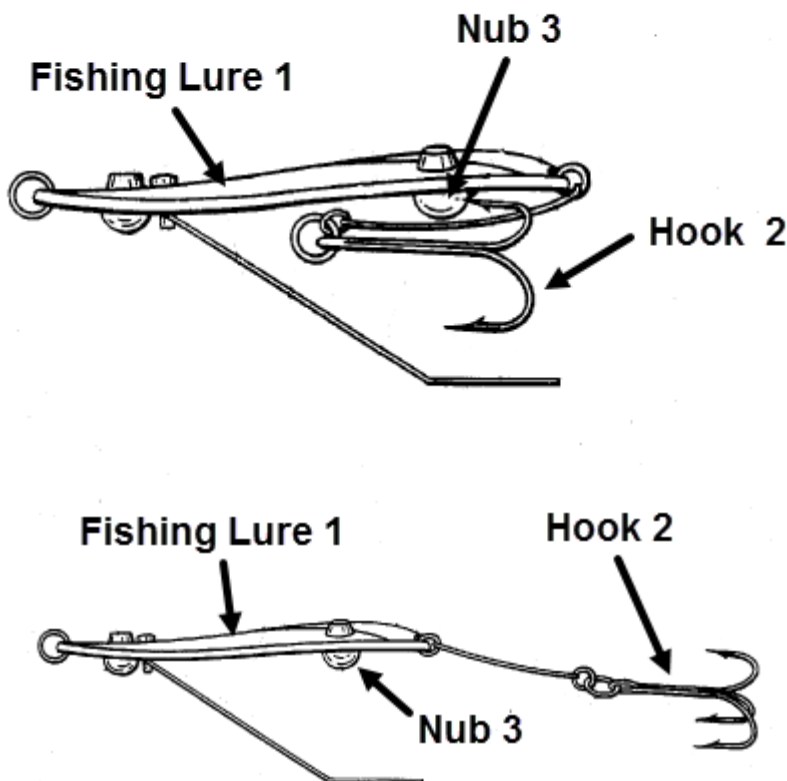

Fishing Lure 1 comprises a hook 2 which is normally held in position against the fishing lure 1 by a nub 3, but upon the strike of a fish the hook 2 is moved relative to the fishing lure 1 and freed from the nub 3 so that the fish can be held securely.



## A01K 85/1863

### Definition statement

*This place covers:*

Lures with movable body parts or attracting means which are actuated by a surge of the fishing line and which are biased to return to their original position when the line is given slack.

Illustrative example of subject matter classified in this group.

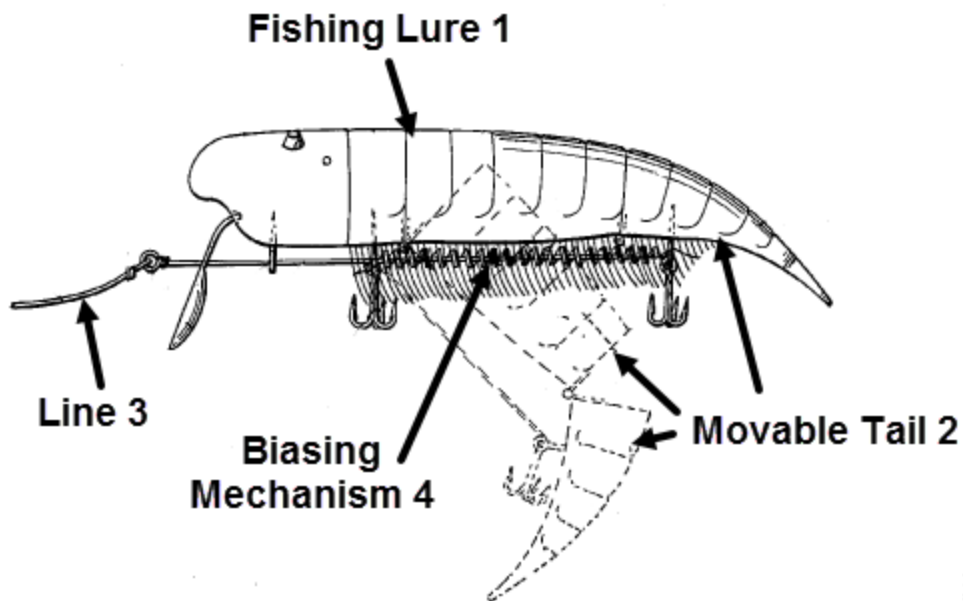

Fishing Lure 1 comprises a movable tail 2 which is actuated by a surge of the fishing line 3, wherein the movable tail 2 is biased to return to its original position by a biasing mechanism 4 when the line 3 is given slack.

## A01K 85/1867

### Definition statement

*This place covers:*

Lures adapted (1) for attaching the lure to the line by means other than a mere eye or loop on the line or line connector, or a mere eye or hole on or in the lure body, or (2) for attaching the lure to the line at points other than the margin or extremity of the lure body.

Illustrative example of subject matter classified in this group.

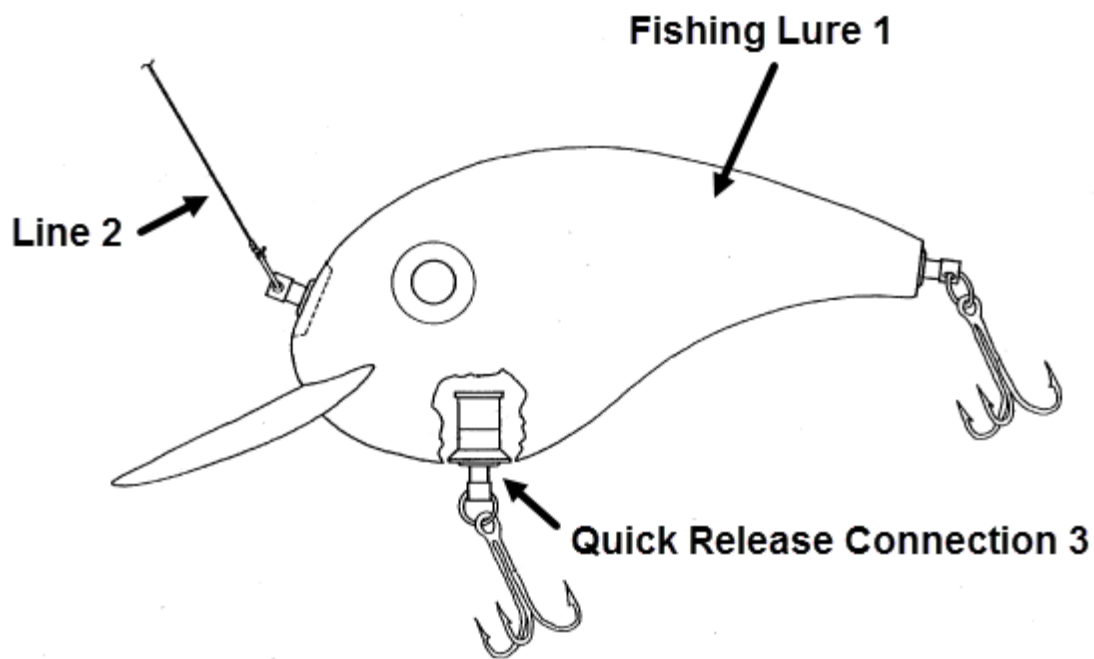

DATE: FEBRUARY 1, 2022

PROJECT RP0258

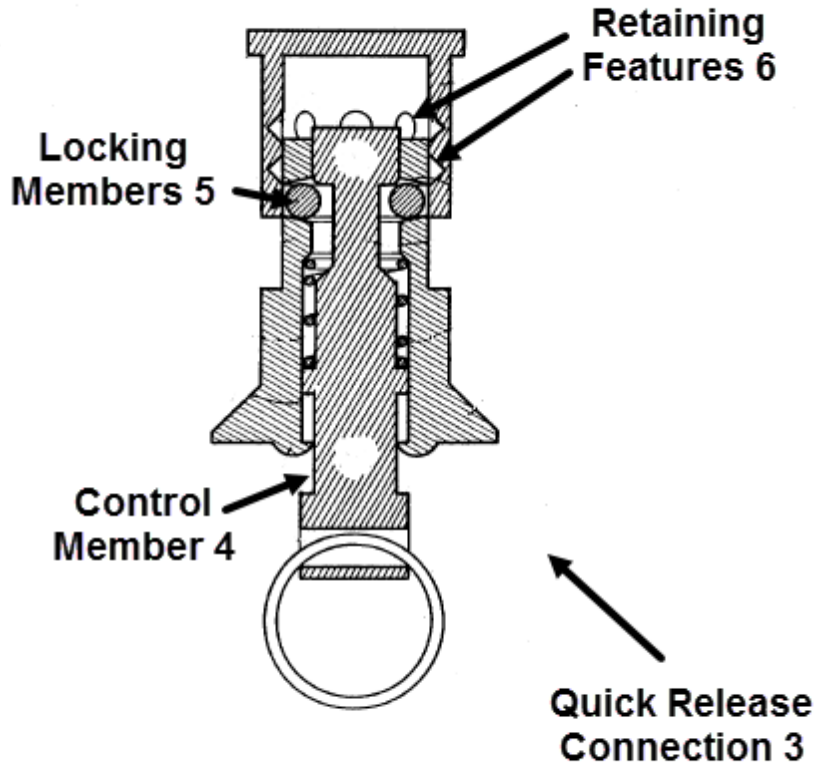

Fishing lure 1 is adapted for being attached to the line 2 by a quick release connection 3, wherein the quick release connection 3 can be disconnected by pulling on a control member 4 to cause locking members 5 to withdraw from retaining features 6.

DATE: FEBRUARY 1, 2022

PROJECT RP0258

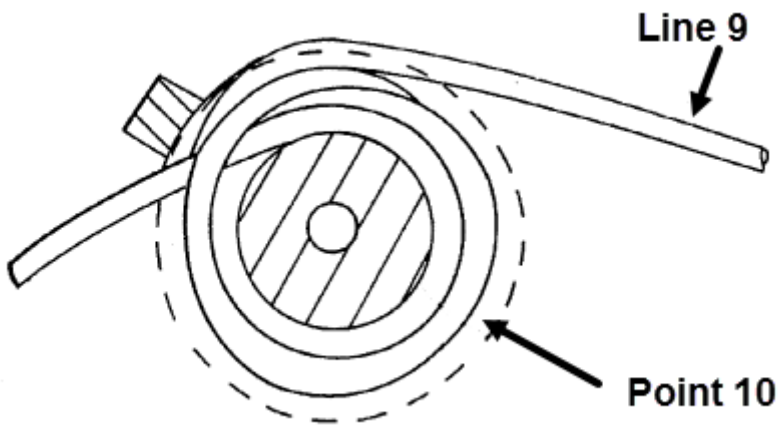
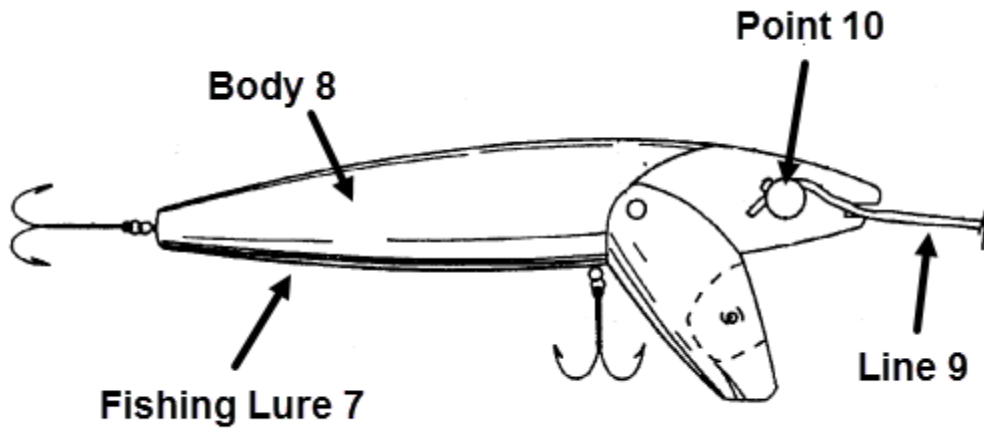

Fishing lure 7 comprises a body 8, wherein the fishing lure 7 is adapted to be attached to the line 9 at a point 10 other than the margin or extremity of the lure body 8 by wrapping the line 9 around the point 10 located within the body 8.

## A01K 85/1871

### Definition statement

*This place covers:*

Lures comprising a plurality of lures all connected to a single line or to each other, or a plurality of rigid lure members movably connected to one another. Plural lures comprise only (1) plural duplicate complete lures, or (2) plural lures, two or more of which have at least one lure member of rigid material. The rigid members may or may not be body simulating parts, and may be of solid form, spoon-like, in shape of an impeller with oppositely directed blades; e.g., spinners, etc.

Illustrative example of subject matter classified in this group.

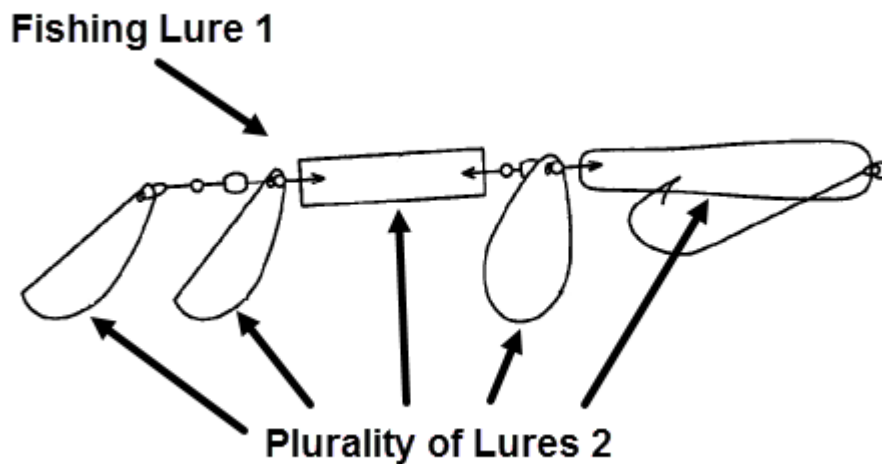

Fishing lure 1 comprises a plurality of lures 2 which are movably connected to each other.

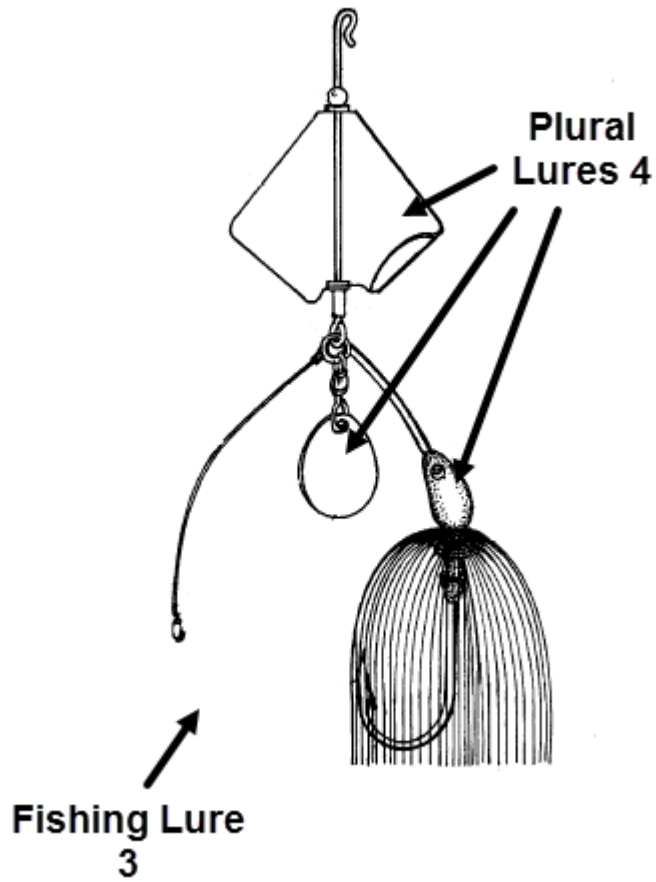

Fishing lure 3 comprises plural lures 4 which are of rigid material.

## A01K 85/1873

### Definition statement

*This place covers:*

Lures comprised of plural members, at least one lying within another, one or more of which members are designed to rotate as the bait is drawn through the water. If the inner member or members rotate, their bearings or shaft ends or points of attachment must be within the confines of the outer body. If more than one member rotates, their motion must be independent.

Illustrative example of subject matter classified in this group.

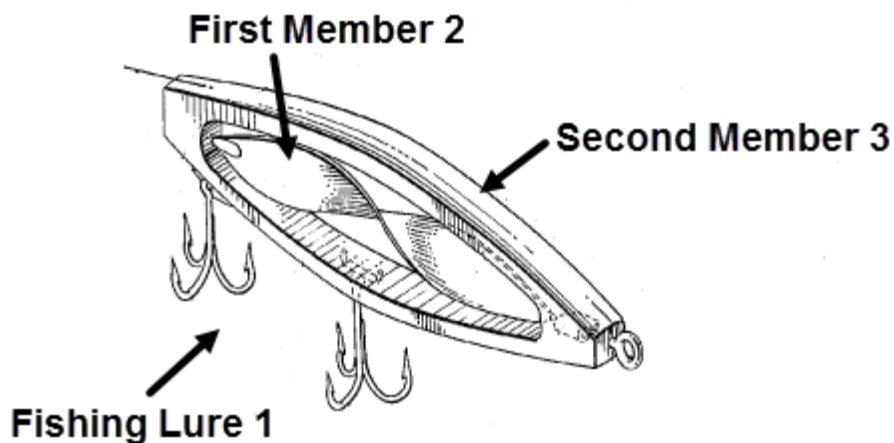

Fishing Lure 1 comprises a rotatable first member 2 both attached to and lying within a non-rotating second member 3, wherein the points of attachment of the first member 2 are within the confines of the second member 3.

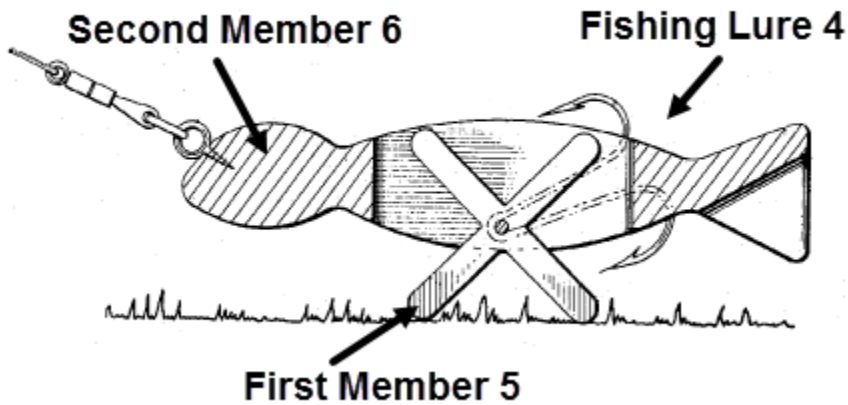

Fishing lure 4 comprises a rotatable first member 5 both attached to and lying within a non-rotating second member 6, wherein the points of attachment of the first member 5 are within the confines of the second member 6.

## **A01K 85/1877**

### **Definition statement**

*This place covers:*

Lures comprising a lure with two or more movably or pivotally connected rigid members either offset from the body or attached intermediate the ends of the body to rotate or swing about a pivotal connection. The members may be spoons, spinners, or mere vanes or appendages.

Illustrative example of subject matter classified in this group.



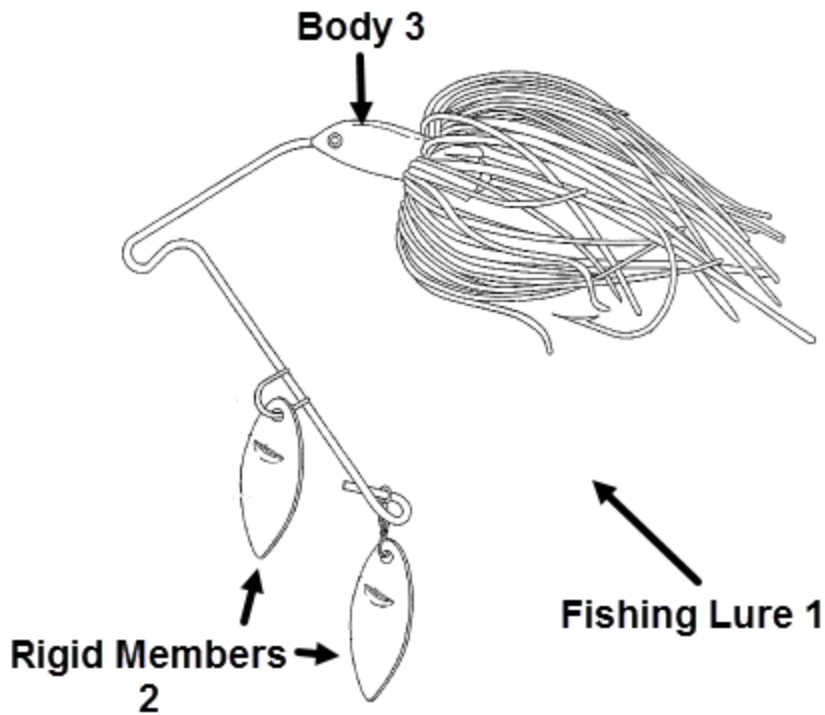

Fishing lure 1 comprises two movably connected rigid members 2 offset from the body 3, wherein the rigid members 2 are spinners.

## **A01K 85/1881**

### **Definition statement**

*This place covers:*

Lures comprising a lure with two or more movably or pivotally connected rigid members either offset from the body or attached intermediate the ends of the body to rotate or swing about a pivotal connection. The members may be spoons, spinners, or mere vanes or appendages.

Illustrative example of subject matter classified in this group.

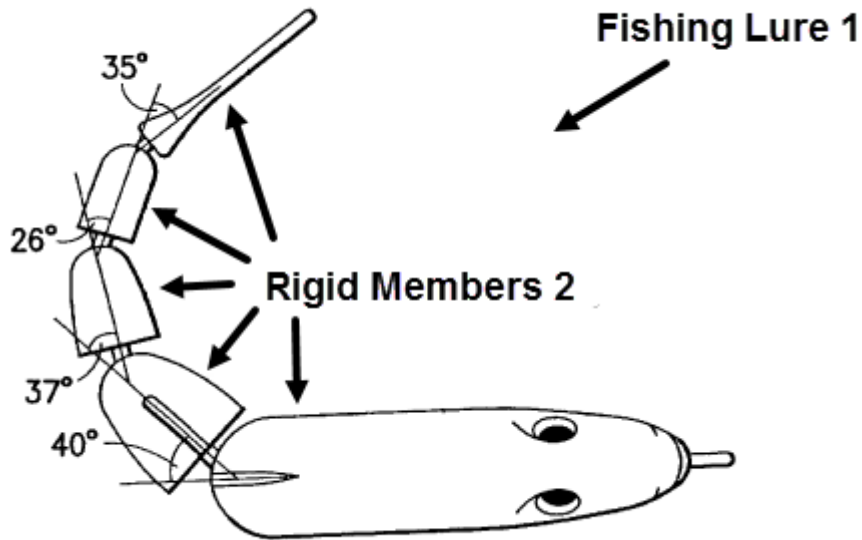

Fishing lure 1 comprises pivotally connected rigid members 2 attached intermediate the ends of the fishing lure 1.

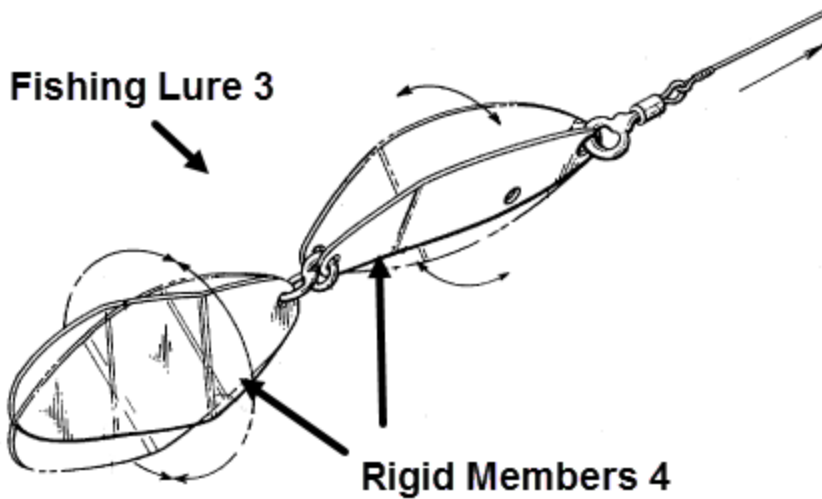

Fishing lure 3 comprises two pivotally connected rigid members 4 attached intermediate the ends of the fishing lure 3, wherein the rigid members 4 are spoons.

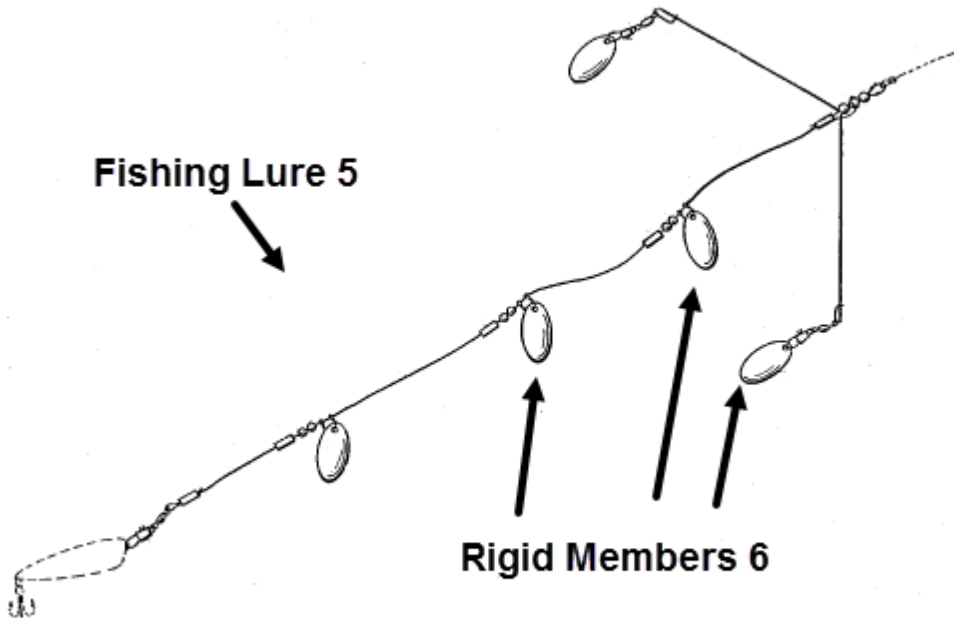

Fishing lure 5 comprises movably connected rigid members 6 attached intermediate the ends of the fishing lure 5, wherein the rigid members 6 are spinners.

## **A01K 85/1883**

### **Definition statement**

*This place covers:*

Lures, one of the bodies or body parts being freely rotatable or revolvable about longitudinal axis, either its own or that of the assembly.

Illustrative example of subject matter classified in this group.

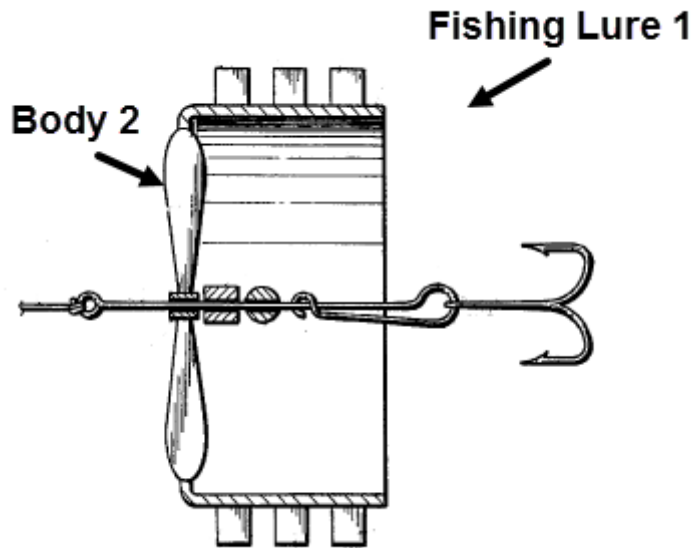

Fishing lure 1 comprises a body 2 which is freely rotatable about a longitudinal axis of the fishing lure 1.

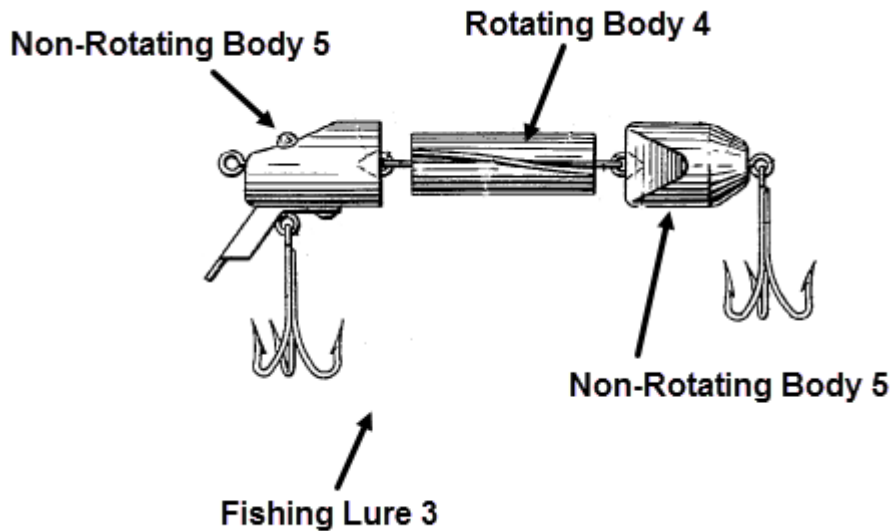

Fishing lure 3 comprises a rotating body 4 and non-rotating bodies 5 which are movably connected in series, wherein the rotating body 4 is freely rotatable about the longitudinal axis of the fishing lure 3.

## A01K 85/1887

### Definition statement

*This place covers:*

Lures in which the member which rotates (1) is of sheet material form, (2) is mounted on the hook or hook connector, and (3) precedes and rotates independently of the other lure members. The other lure member is usually the main attracting element of the lure, such as a plug or spoon or simulation of a live bait as a minnow, shellfish, etc.

Illustrative example of subject matter classified in this group.

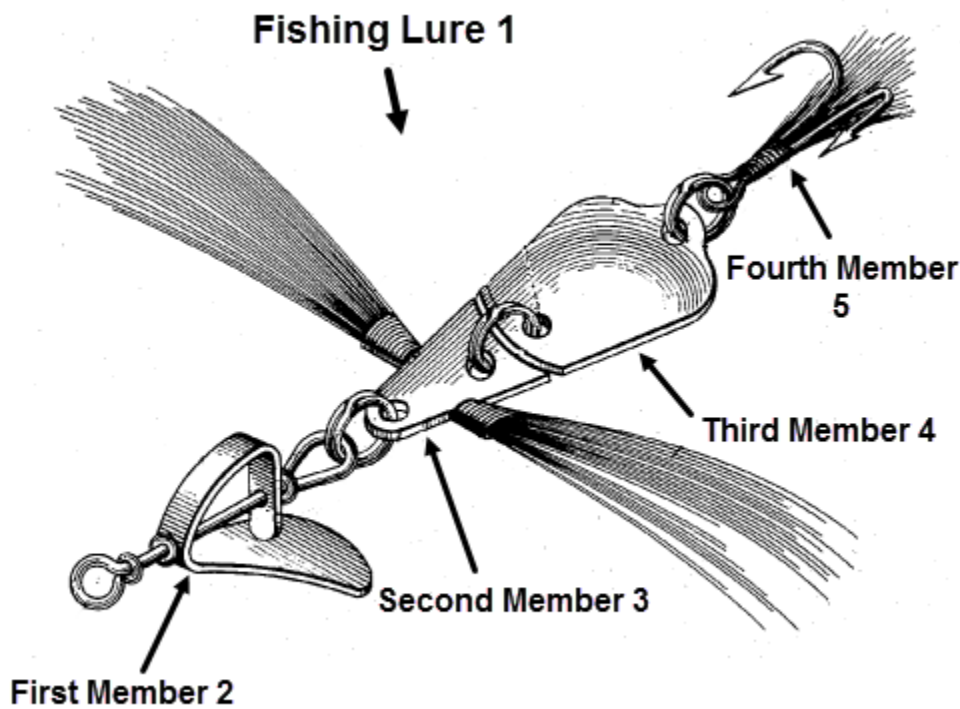

Fishing Lure 1 comprises a first member 2, a second member 3, a third member 4, and a fourth member 5 which are movably connected in series, wherein the first member 2 is made of sheet material, precedes the other members 3-5, and rotates about its longitudinal axis.

## A01K 85/1891

### Definition statement

*This place covers:*

Lures which are constructed of sheet material or material the cross-section of which forms a line rather than an area.

Illustrative example of subject matter classified in this group.

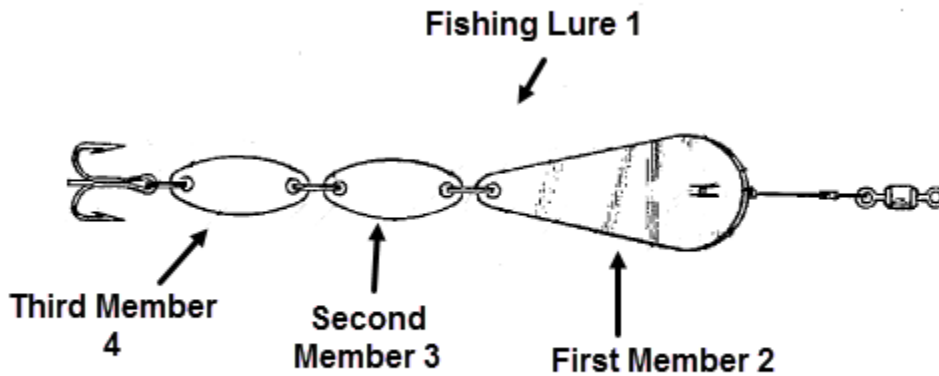

Fishing Lure 1 comprises a first member 2, a second member 3, and a third member 4 which are movably connected in series, wherein the members 2-4 are made of sheet material.

## A01K 85/1893

### Definition statement

*This place covers:*

Lures with relatively movable parts which are actuated by a motor. The term "motor", as used here, includes electric, spring, fluid, or other motors, and mechanisms for deriving energy from the relative motion of the surrounding media and transmitting it through shafts or relatively movable parts to move the apparatus or part of it.

Illustrative example of subject matter classified in this group.

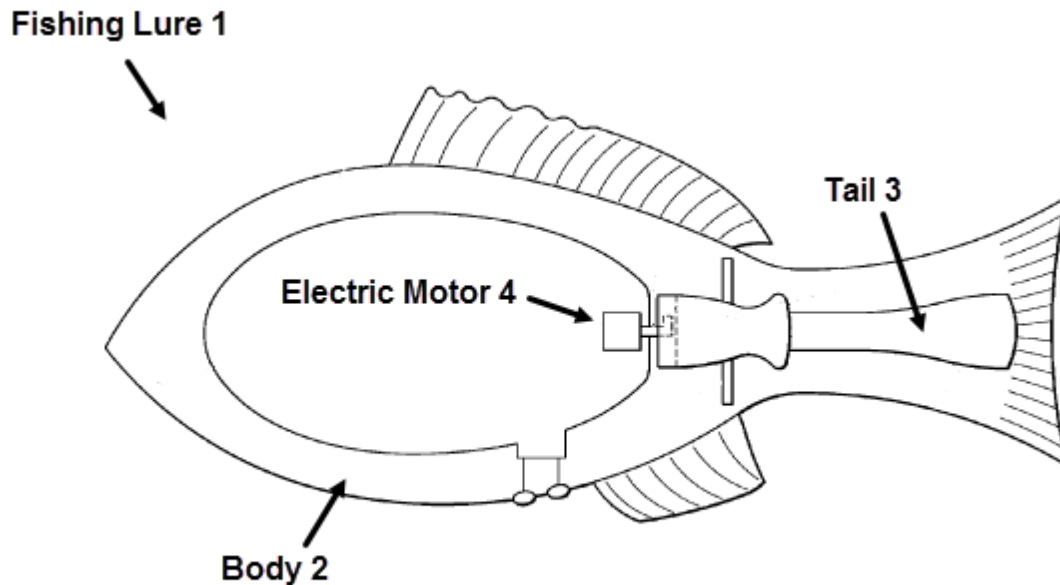

Fishing lure 1 comprising a body 2, a tail 3, and an electrical motor 4 which drives the tail 3 to cause the tail 3 to move relative to the body 2.

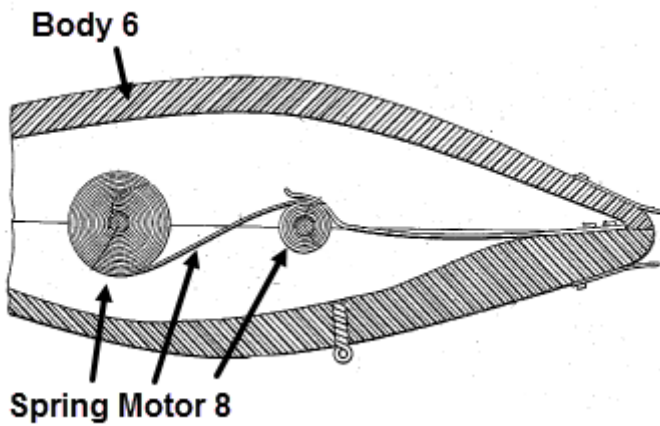
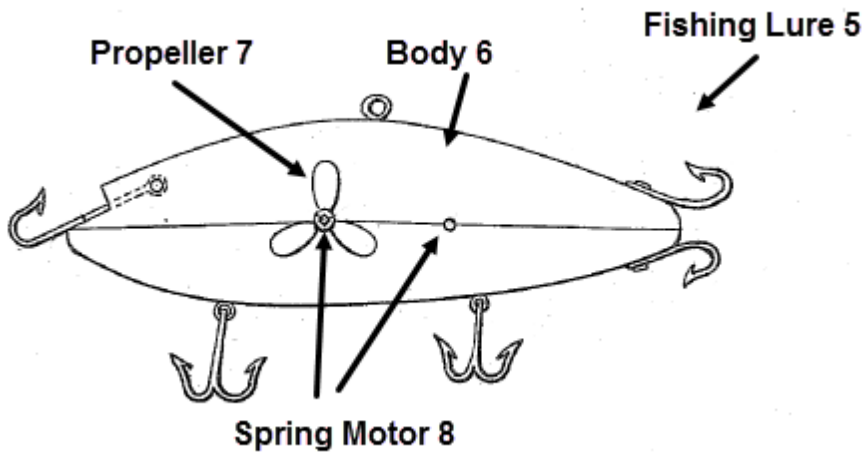

Fishing lure 5 comprising a body 6, a propeller 7, and a spring motor 8 which drives the propeller 7 to cause the propeller 7 to move relative to the body 6.



DATE: FEBRUARY 1, 2022

PROJECT RP0258

## **A01K 85/1897**

### **Definition statement**

*This place covers:*

Methods of making and constructing lures not otherwise classified.

## **A01K 87/009**

### **Definition statement**

*This place covers:*

Attachments for fishing rods, wherein the devices functioning to (1) support the line, hook, lure, and/or any line-attached body for purposes of facilitating transportation of the rod, or (2) to provide convenient stowage for hooks, lures, bait, and other articles used in or on fishing tackle.

Illustrative example of subject matter classified in this group.

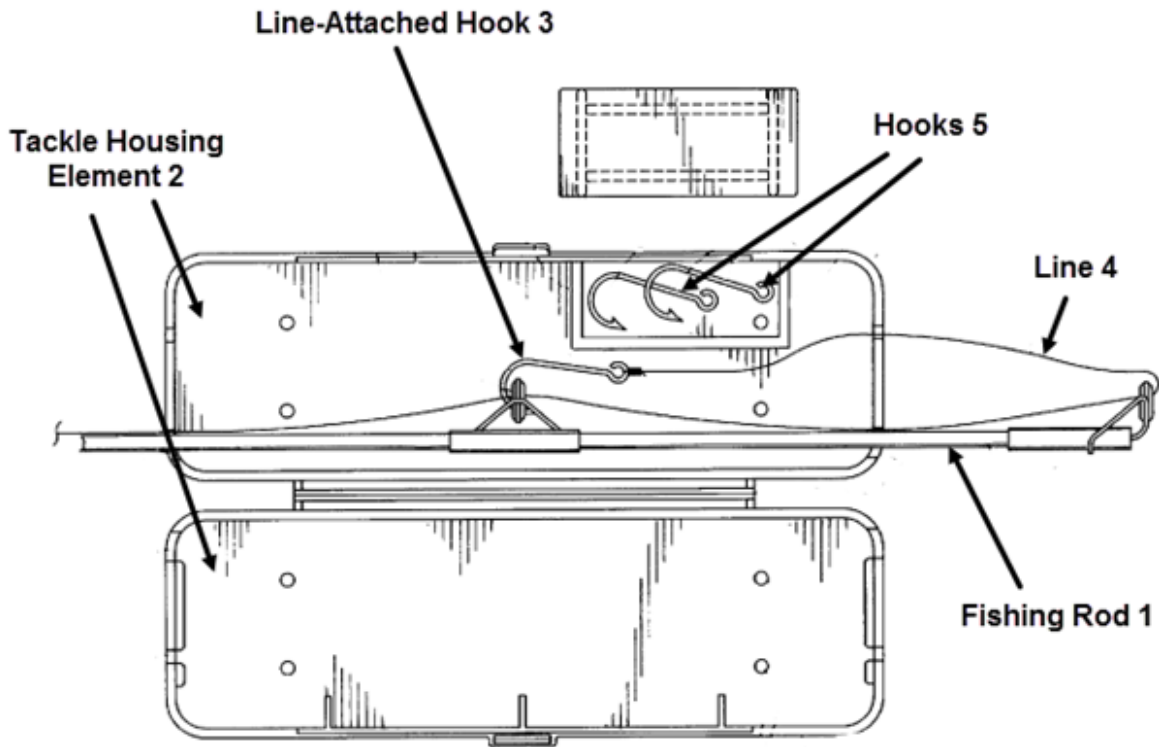

Fishing rod 1 has attached thereto a tackle housing element 2 for supporting and storing a line-attached hook 3 attached to line 4 and for stowage of hooks 5.

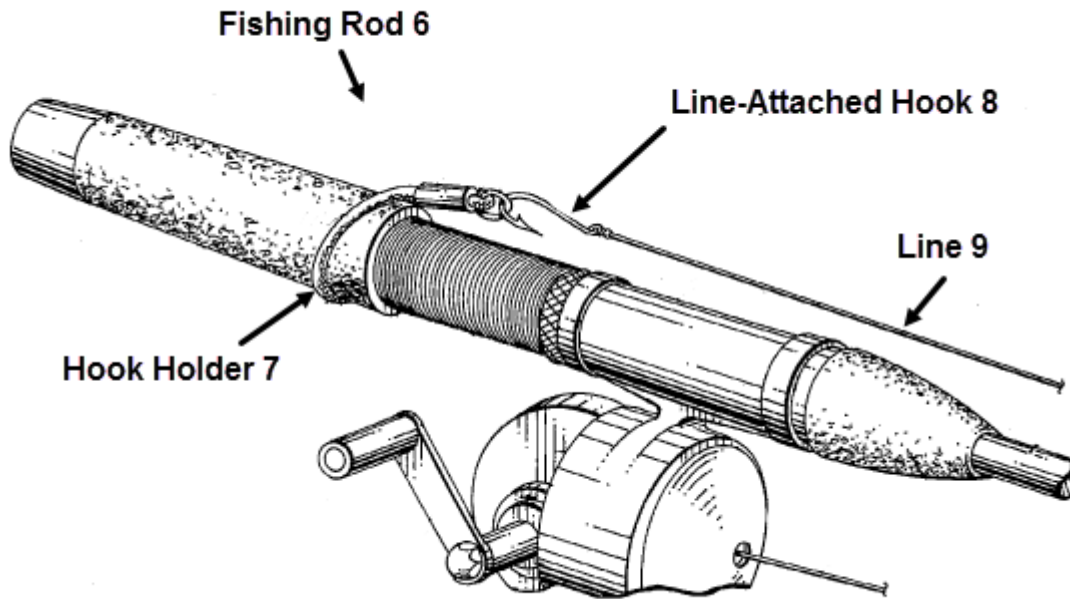

Fishing rod 6 has attached thereto a hook holder 7 for supporting and storing hook a line-attached hook 8 attached to line 9.

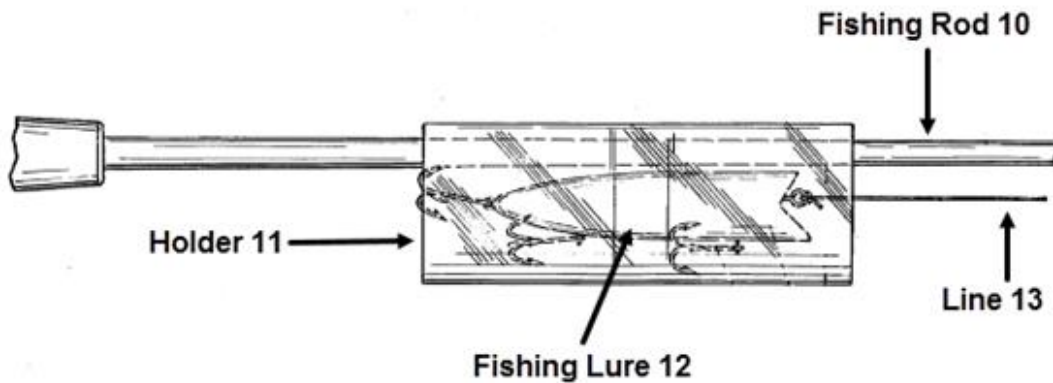

Fishing rod 10 has attached thereto a holder 11 for supporting and storing a fishing lure 12 attached to line 13.

## References

### Informative references

Attention is drawn to the following places, which may be of interest for search:

CPC NOTICE OF CHANGES 1252

DATE: FEBRUARY 1, 2022

PROJECT RP0258

Containers or holders for hooks, lines, sinkers, flies or the like	<a href="#">A01K 97/06</a>
Fishing rods	<a href="#">A01K 87/007</a>

## 2. A. DEFINITIONS (modified)

### A01K 73/02

#### Definition statement

Replace: The existing Definition statement and image(s) with the updated Definition statement and images below.

Subject matter wherein the nets for catching fish or other marine animals are shaped to form a large, flattened bag and are adapted to be towed behind a boat or a vessel at a desired depth in a body of water.

Illustrative example of subject matter classified in this group.

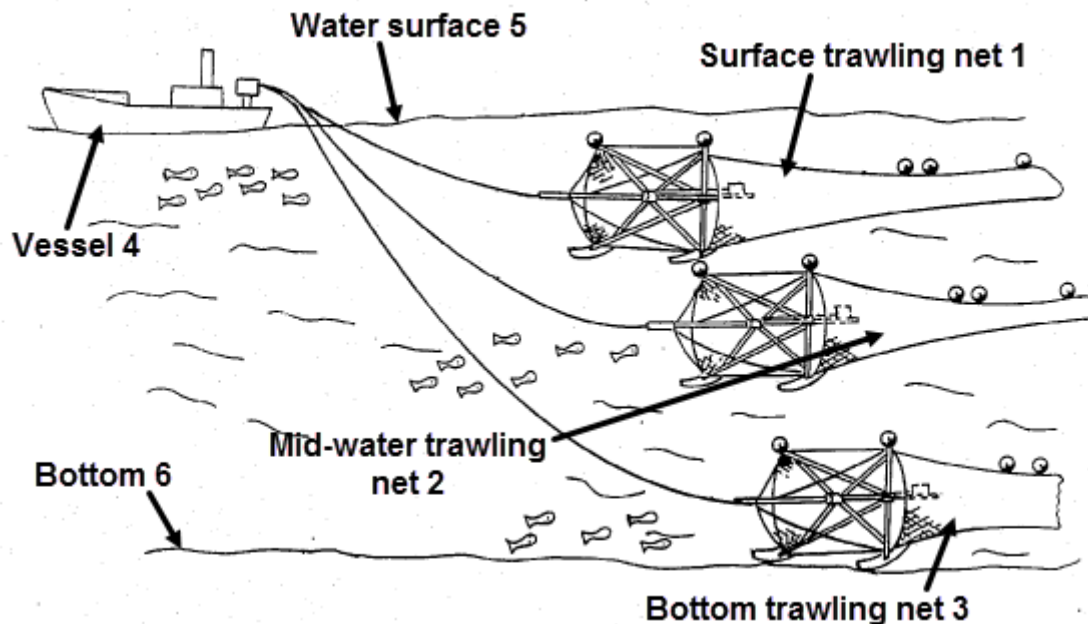

Trawling nets 1-3 include a surface trawling net 1 positioned adjacent the water surface 5, a mid-water trawling net 2 positioned midway between the water surface 5 and the bottom 6, and a bottom trawling net 3 positioned adjacent the bottom 6, wherein the trawling nets 1-3 are towed behind a vessel 4 for catching fish or other marine animals.

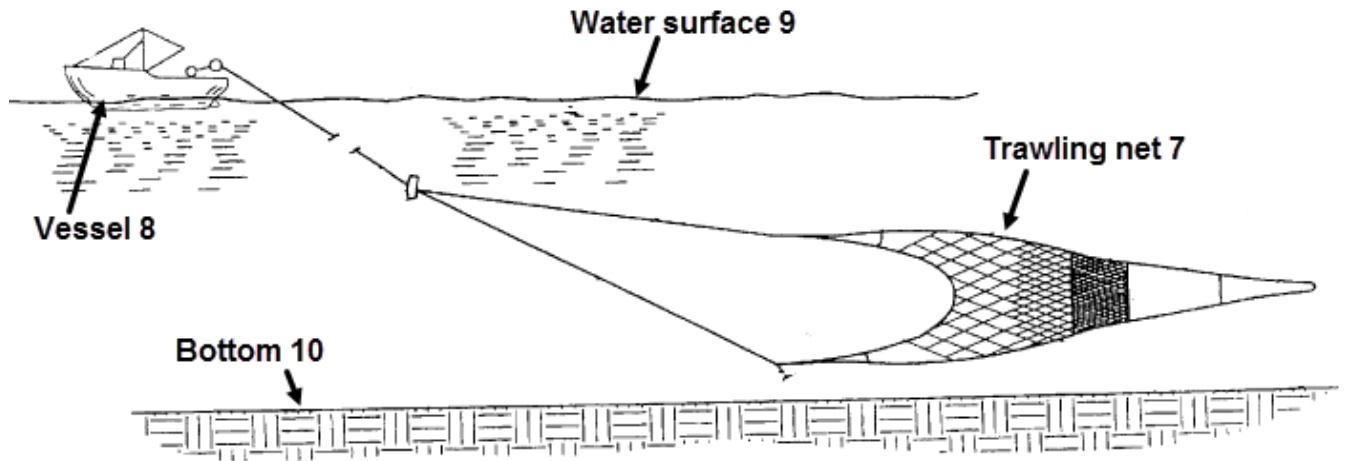

Trawling net 7 is towed behind vessel 8 at a selected depth between the water surface 9 and the bottom 10 in a body of water for catching fish or other marine animals.

## A01K 73/025

### Definition statement

Replace: The existing Definition statement with the updated one, including images, below.

Devices for regulating the depth of fishing nets, e.g. with adjustable angle of elevation.

Depth controlling devices.

Devices for keeping nets closer to the seabed, e.g. ground rope, etc.

Illustrative example of subject matter classified in this group.

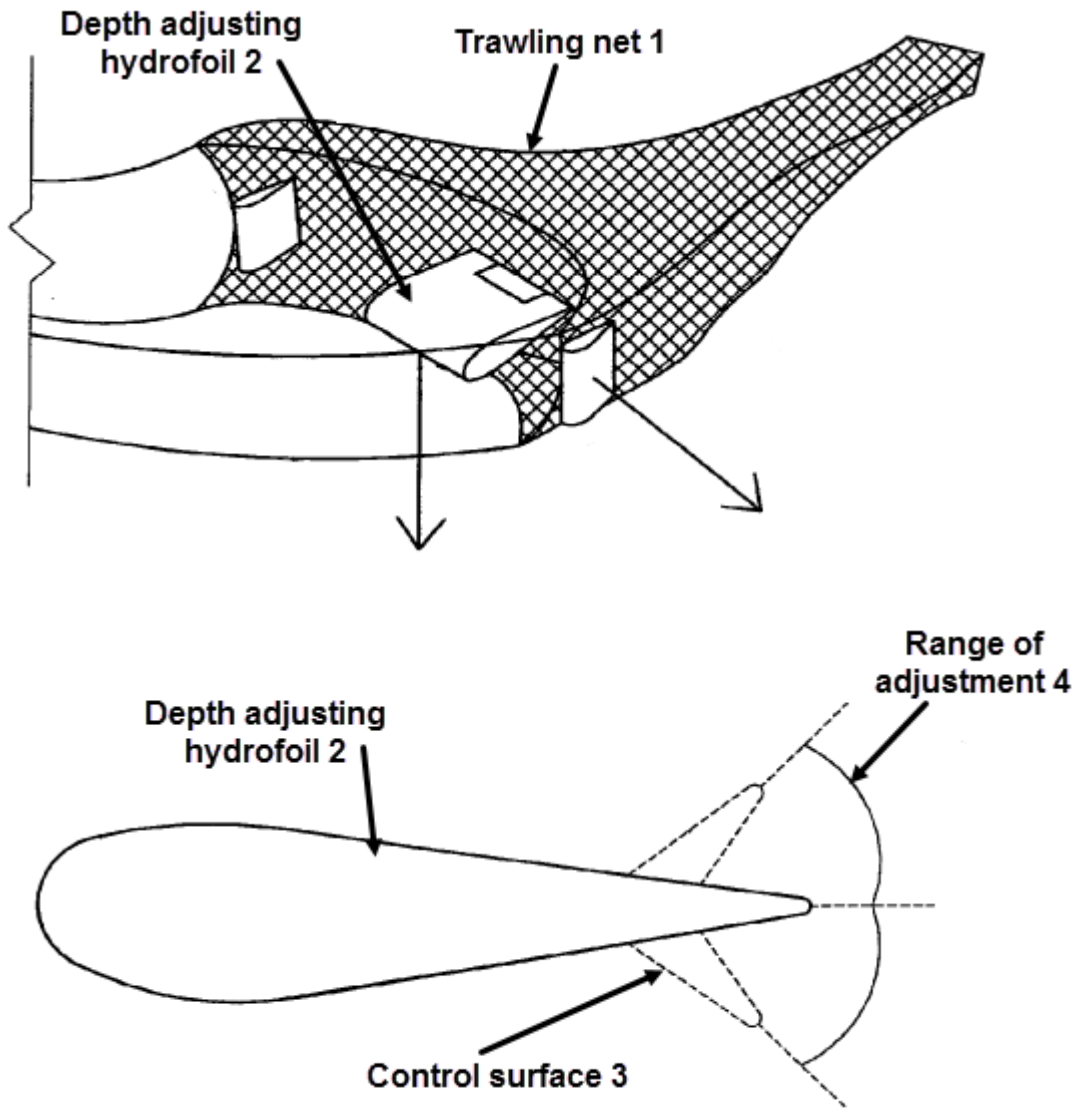

Trawling net 1 has a depth adjusting hydrofoil 2 with a control surface 3 that can be moved within a range of adjustment 4 to control the depth at which the trawling net 1 travels in a body of water.

## A01K 73/04

### Definition statement

Replace: The existing Definition statement with the updated one, including images, below.

Devices for spreading and/or positioning fishing nets, e.g. float boards, special net fabric, etc.

Opening devices for nets e.g. collapse-mechanism, etc.

Steering devices for nets.

Devices for monitoring the angle settings of wires.

Illustrative example of subject matter classified in this group.

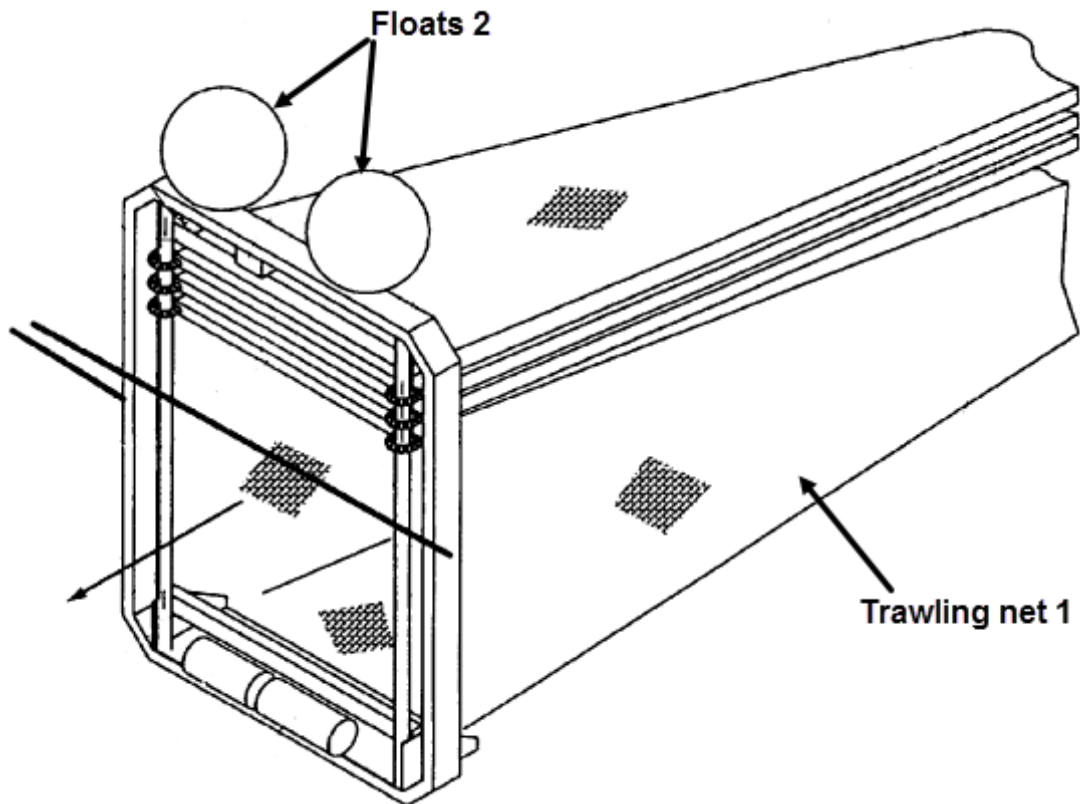

Trawling net 1 is positioned in an upright orientation by floats 2 mounted thereto.



DATE: FEBRUARY 1, 2022

PROJECT RP0258

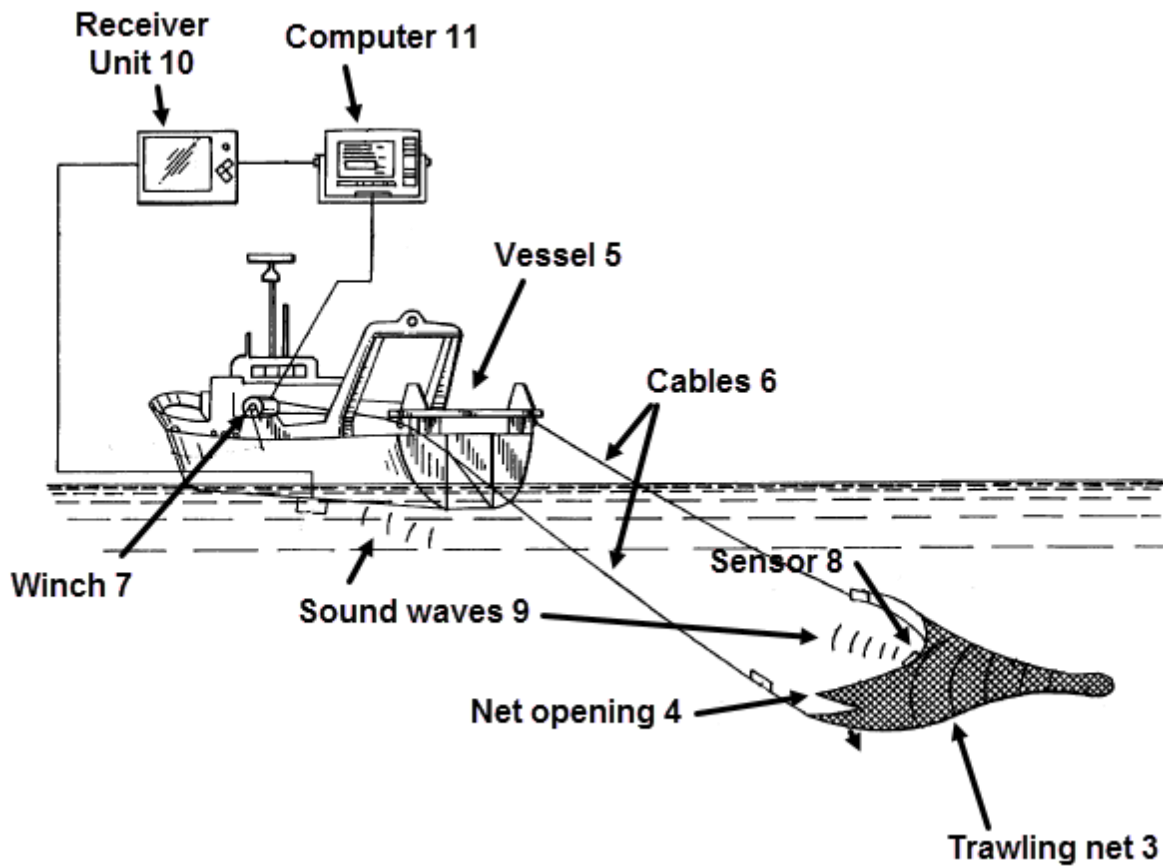

Trawling net 3 having a net opening 4 is towed by a vessel 5 via cables 6 which extend between the net opening 4 and winches 7 located on the vessel 5. A sensor 8 detects the speed and direction of the net and this information from the sensor 8 is transmitted to the vessel 5 via soundwaves 9 where it is received by a receiver unit 10 for transmission to a computer 11 which is in communication with the winches 7. The winches 7 are operated by the computer 11 to adjust the tension in the cables 6 so as to maintain the net opening 4 in the desired position as the trawling net 3 is being drawn in the body of water.

## A01K 73/045

### Definition statement

Replace: The existing Definition statement with the updated one, including images, below.

Subject matter wherein the large, flattened bag shaped net includes detailed panel structure, which, when engaged by a stream of water generated as the net is towed through the body of water, helps hold an entry area of the net agape for the fish or other aquatic animals to pass through. These devices are also referred to as otter boards and trawl doors.

Illustrative example of subject matter classified in this group.

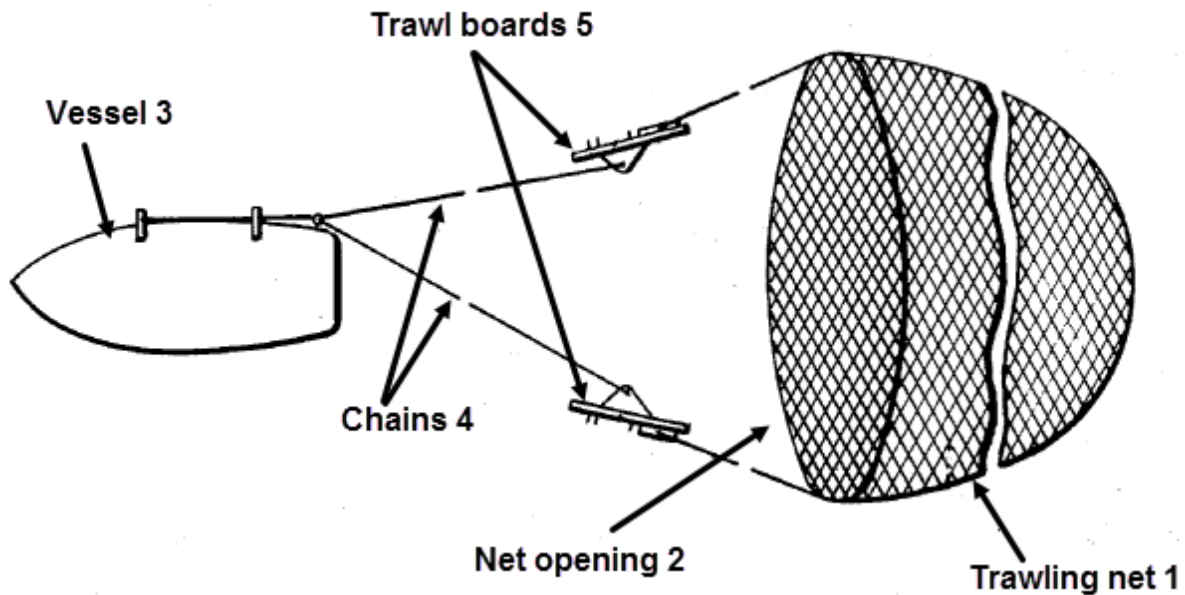

Trawling net 1 having a net opening 2 is towed behind a vessel 3 via chains 4, wherein trawl boards 5 assist in holding the net opening 2 agape for fish or other aquatic animals to pass therethrough as the flow of water generated by towing the trawling net 1 acts upon the trawl boards 5.

DATE: FEBRUARY 1, 2022

PROJECT RP0258

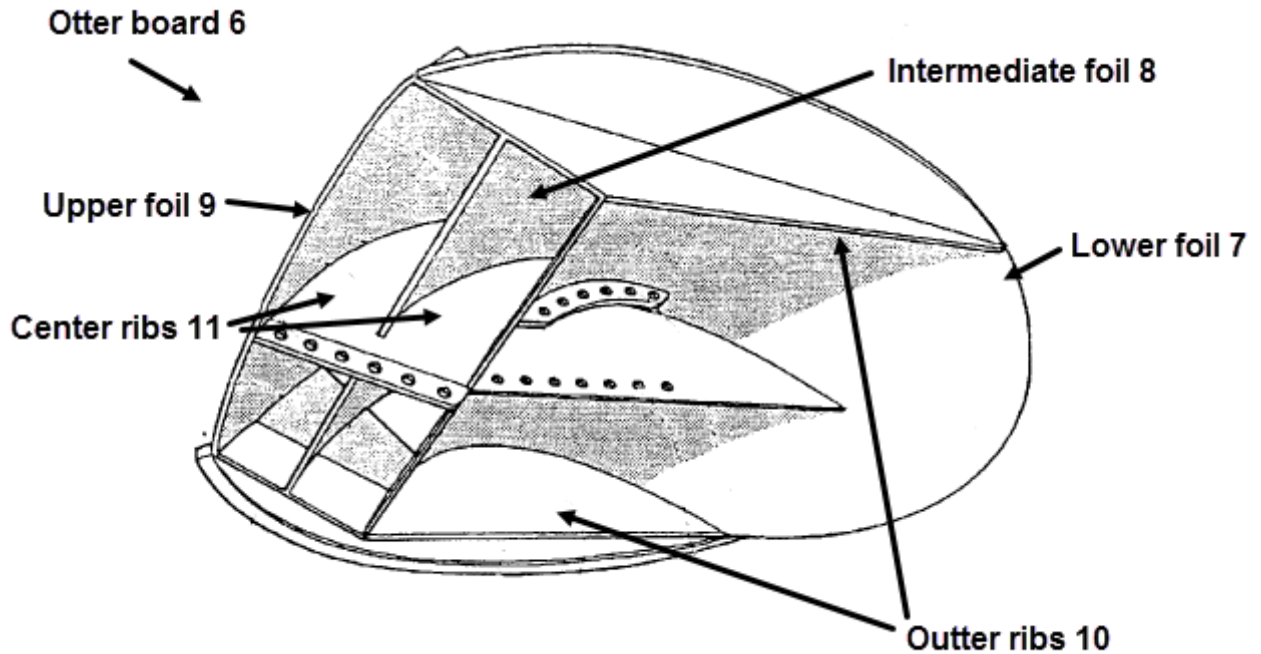

Otter Board 6 has a lower foil 7, an intermediate foil 8, and an upper foil 9 which are arranged with respect to each other by outer ribs 10 and center ribs 11, wherein the foils 7-9 and ribs 10-11 form channels that assist the otter board 6 in generating spreading forces as the otter board 6 travels in the water in connection with a trawling net so as to assist in holding a mouth of the trawling net open for fish or other aquatic animals to pass therethrough.

## A01K 73/05

### Definition statement

Replace: The existing Definition statement with the updated one, including images, below.

Devices for vertical sheering of fishing nets.

Details therefor, e.g. trawling gear, vertical suspensions, otter boards, etc.

Towing devices for nets.

Illustrative example of subject matter classified in this group.

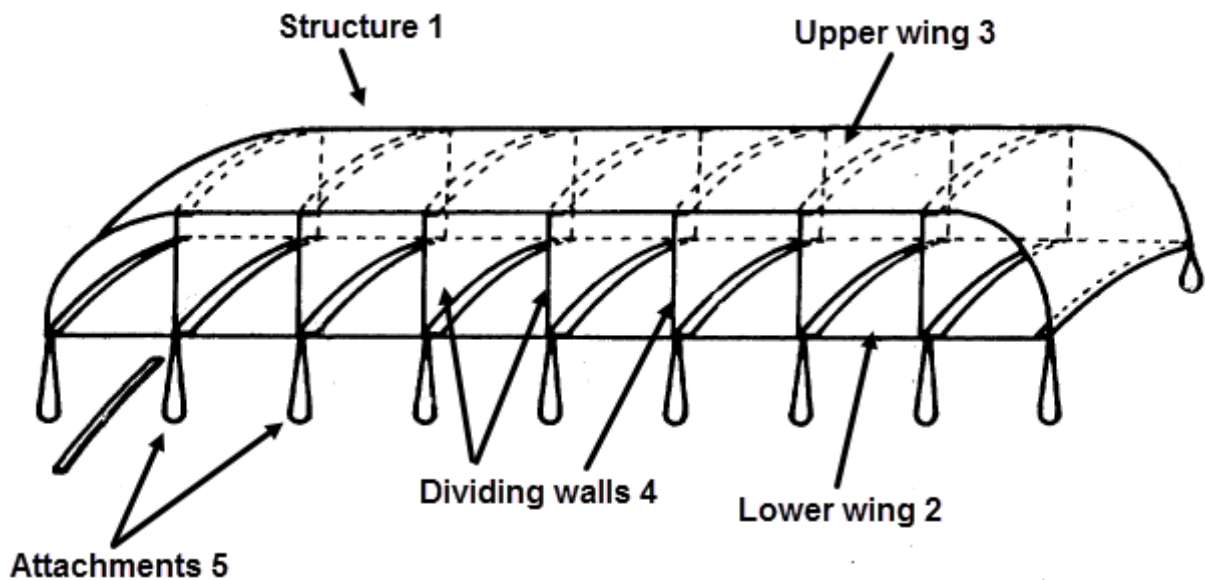

A structure 1 has a lower wing 2, an upper wing 3, dividing walls 4, and attachments 5 for attaching the structure 1 at an upper portion of a mouth of an existing trawling net, wherein the lower and upper wings 2-3 generate a lifting force to the trawling net to assist in the vertical opening of the mouth of the trawling net.

## A01K 73/053

### Definition statement

Replace: The existing Definition statement with the updated one, including images, below.

Rollers, wheels or balls intended to roll over the ground substantially in trawl direction.

Ground-line rollers for fishing nets, e.g. footrope construction, etc.

Trailing devices, lead lines for fish nets, guide wheels, ground rope, tail planes, etc.

They may be attached to other parts of nets or lines than ground lines.

Illustrative example of subject matter classified in this group.

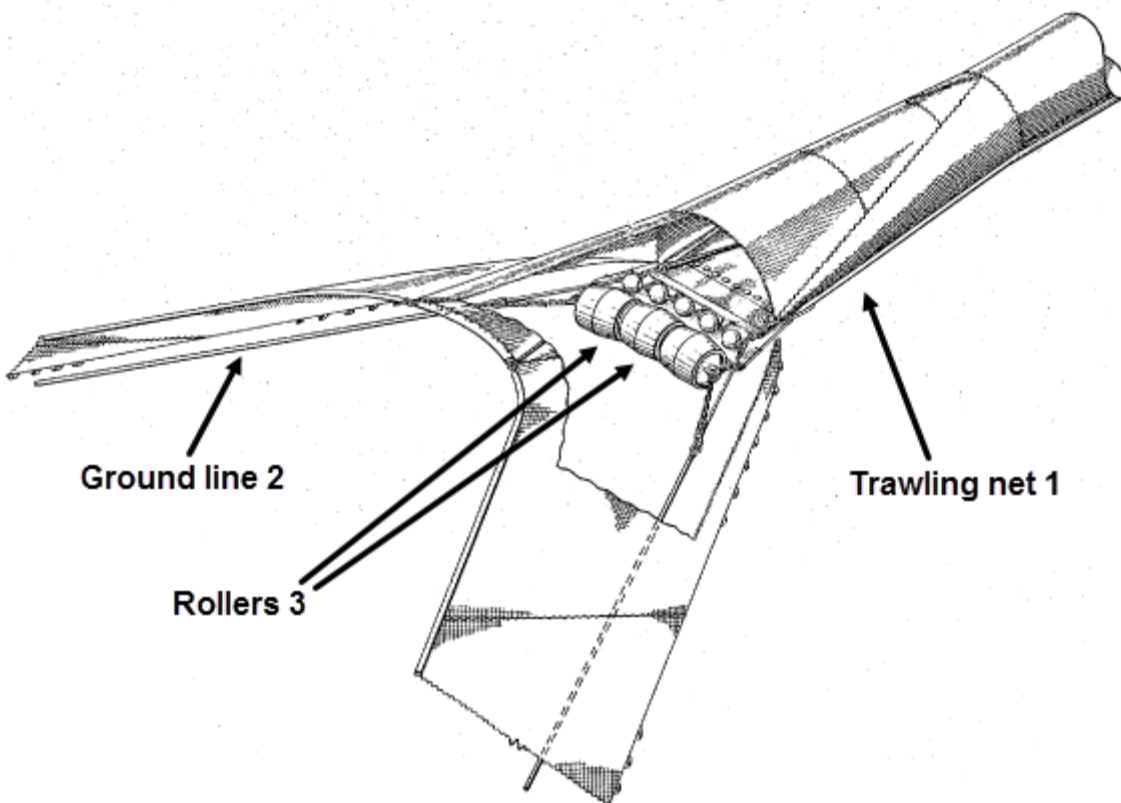

Trawling net 1 for fishing along a bottom of a body of water has a ground-line 2 with rollers 3 attached thereto for reducing friction between the trawling net 1 and the bottom of the body of water.

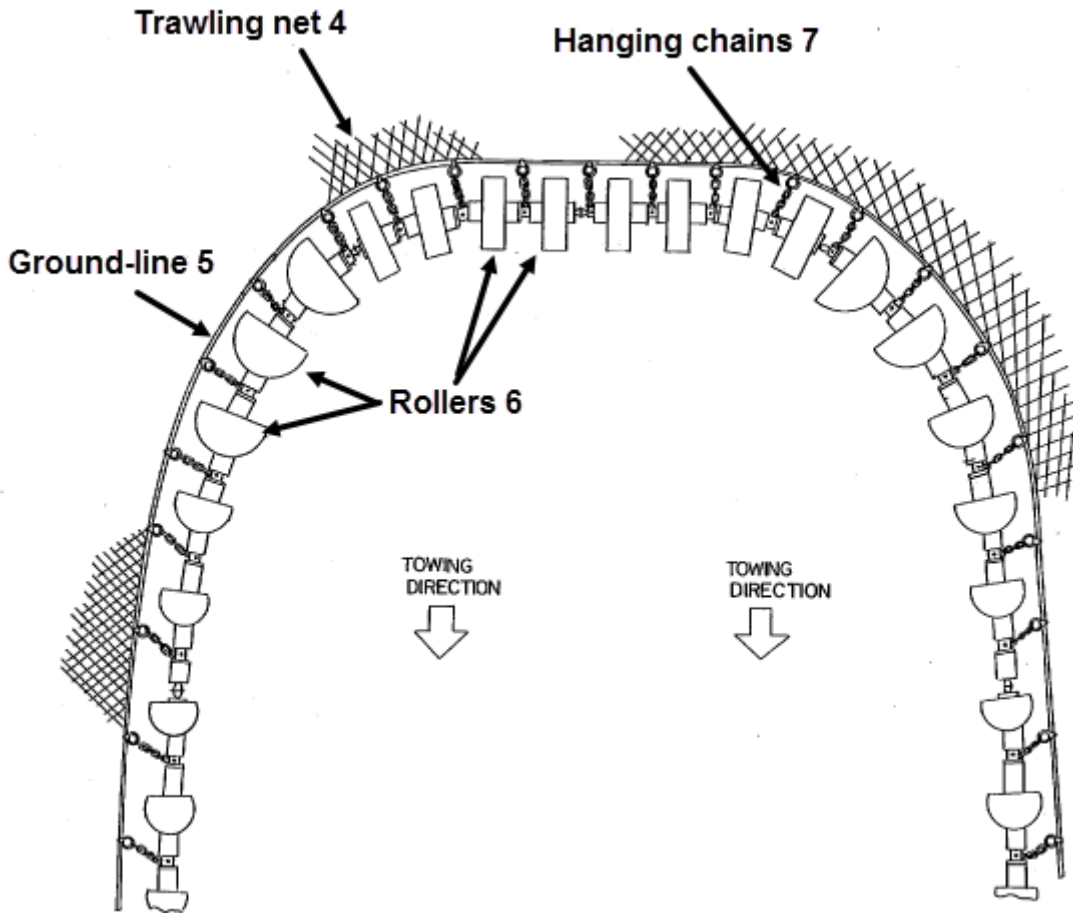

Trawling net 4 for fishing along a bottom of a body of water has a ground-line 5 with rollers 6 attached thereto by hanging chains 7, wherein the rollers assist the trawling net in moving smoothly along the bottom of the body of water.

## A01K 73/06

### Definition statement

Replace: The existing Definition statement with the updated one, including images, below.

Devices or details involved in towing or hauling trawler headlines.

Devices for handling the whole net, e.g. discharging its contents.

Devices for controlling line traction or length or speed.

Winches or their control may be included, also engine control.

Details or headlines, e.g. special links, or load gauges.

Position control of net may also be involved.

Lines to be hauled may serve for other objects, e.g. lobster pots.

Discharging fish from net into boat, e.g. seine-net.

Devices may include devices for oiling/lubrication of cables.

Illustrative example of subject matter classified in this group.

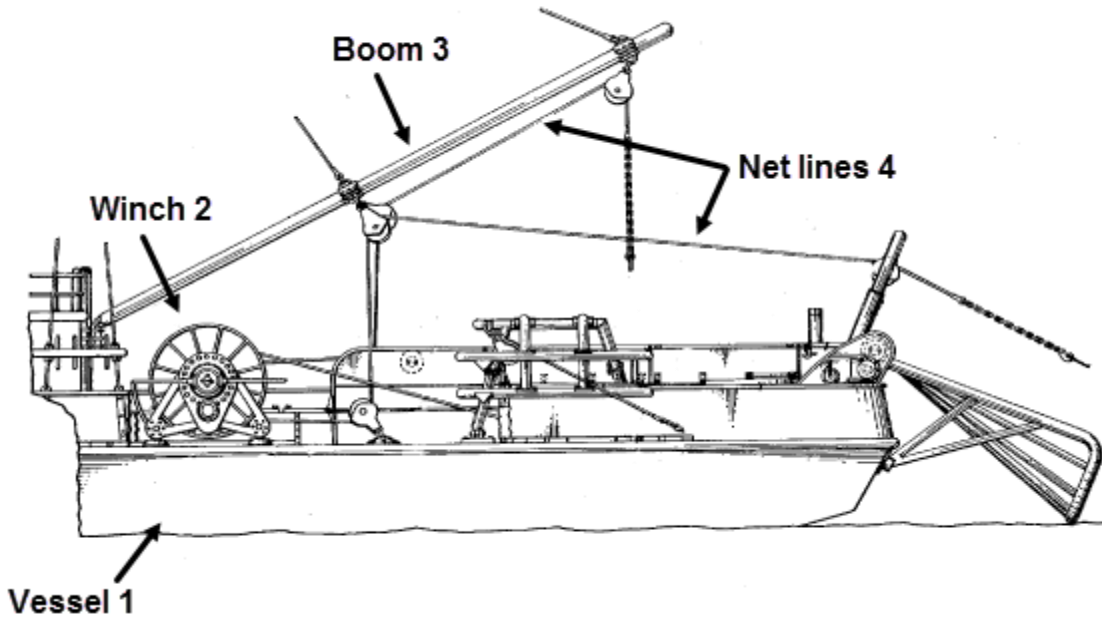

Vessel 1 has a winch 2 and a boom 3 with pulleys for hauling the headlines 4 of the trawling net, wherein the winch 2 has both a central body for reeling on the net body of the trawling net and laterally positioned drums for reeling on the headlines 4 of the trawling net.



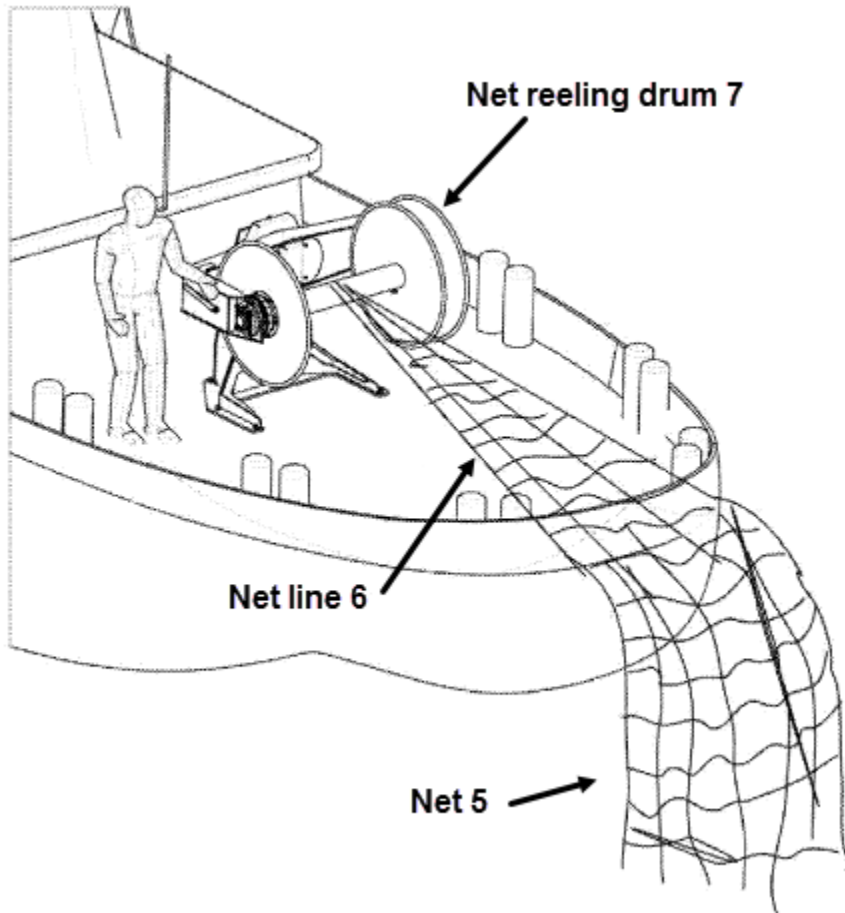

Net 5 having a net line 6 is hauled using a net reeling drum apparatus 7.

### References

Delete: Limiting references section and table.

### *Informative references:*

Insert: The following new row into the Informative references table.

Nets held vertically in the water	<a href="#">A01K73/12</a>
-----------------------------------	---------------------------

## A01K 73/10

### Definition statement

Replace: The existing Definition statement with the updated one, including images, below.

Trawling nets with a structure which (1) restricts the amount by which the net may constrict or expand due to the stress caused by filling the net, (2) restricts the quantity of fish or other aquatic animal permitted to fill the net or (3) signals the amount of fish or other aquatic animal caught upon reaching a particular quantity. Constriction or expansion of the net beyond a certain limit must usually be avoided to prevent damage to the net as the net is filled. A device commonly known as a spiller which releases any excess fish or aquatic animal upon the net reaching a predetermined limit is included here.

Illustrative example of subject matter classified in this group.

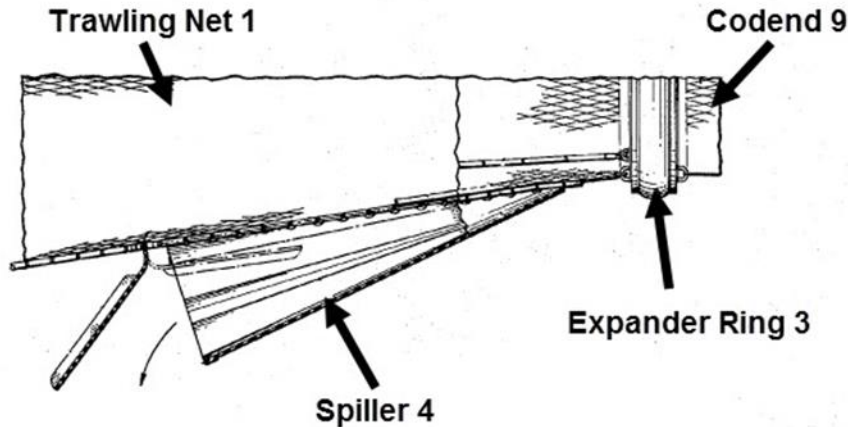

Trawling net 1 includes an expander ring 3 through which fish pass into the codend 9, but fish in excess of the capacity of the codend 9 will press downwardly upon a spiller 4 to cause the spiller 4 to yield downwardly and allow the excess fish to escape.

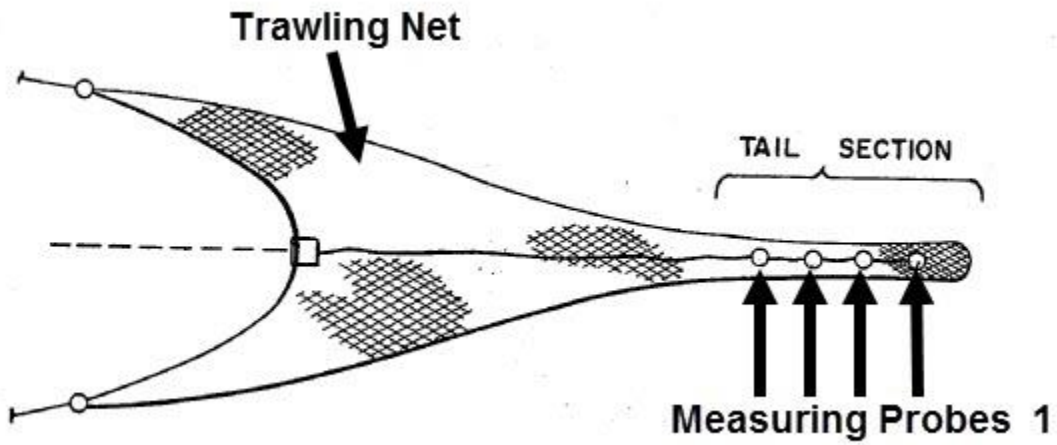

Trawling net includes measuring probes 1 for electronically ascertaining the degree to which the trawling net is filled.

## A01K 75/00

### Definition statement

Replace: The existing Definition statement with the updated one, including images, below.

Structure or manufacture of nets (even if limited to particular kinds of nets) or their cables or wires.

Details of nets, e.g. connectors.

Auxiliary features, e.g. electronic accessories, other than mere illumination.

Measuring devices for or on nets, e.g. for controlling their length.

Protective devices on nets, e.g. armour plates.

Devices embracing floats and/or sinkers, e.g., their embedding in a special cable.

Handling nets (mostly ashore or on board), e.g. holding, and shaking.

Devices for protecting animals, e.g. whale release device, etc.

Cleaning devices for e.g. nets.

Illustrative example of subject matter classified in this group.

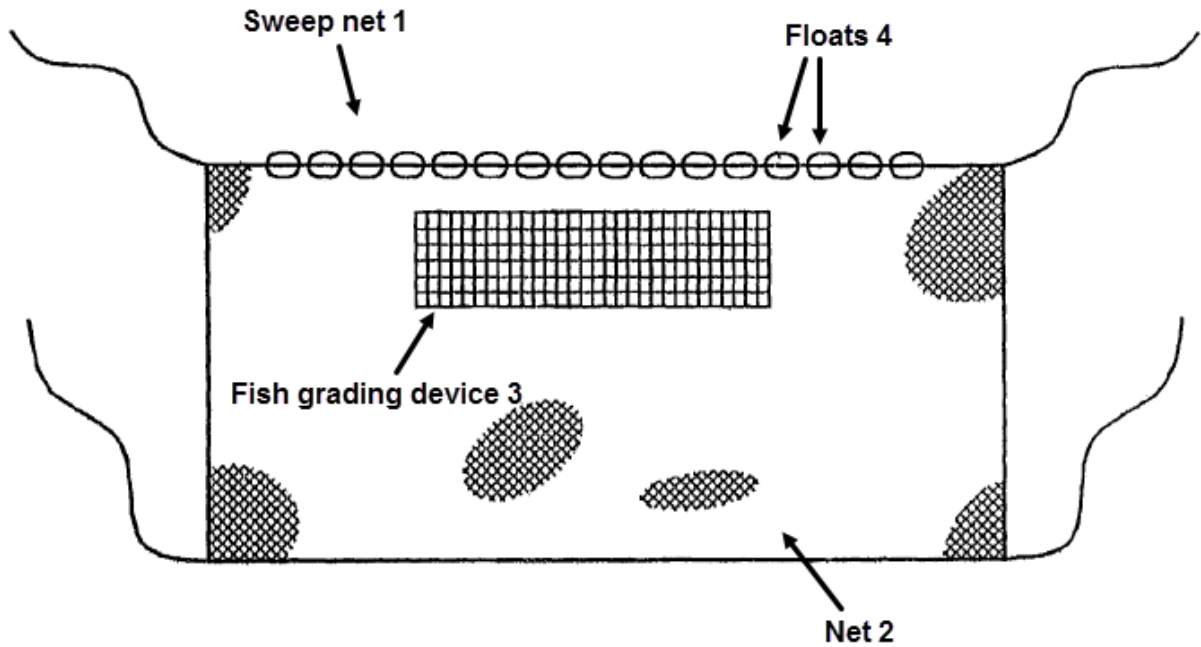

Sweep net 1 has a net 2 and a fish grading device 3, wherein the net 2 is suspended by floats 4 for maintaining the net in a vertical orientation in a body of water and the fish grading device 3 has a mesh size such that fish above a certain size cannot swim through the net and are therefore retained in the sweep net 1.

DATE: FEBRUARY 1, 2022

PROJECT RP0258

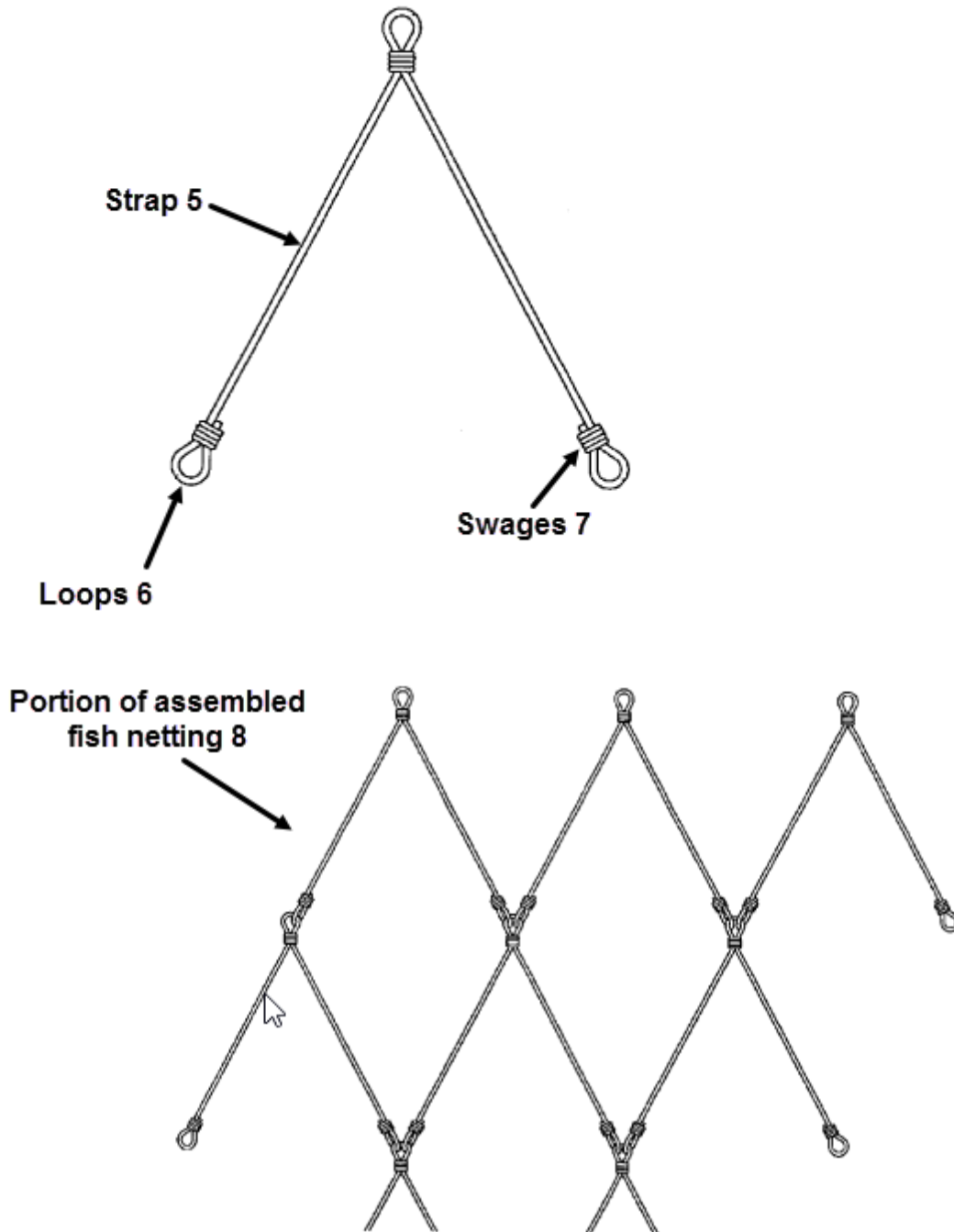

Strap 5 comprises a length of twine forming sides of a mesh and three loops 6 which are formed using swages 7 to secure the loops 6, wherein the straps 5 are joined to each other to form a portion of an assembled fish netting 8 which represents part of a net assembly.

## A01K75/06

### Definition statement

Replace: The existing Definition statement with the updated one below, including the image.

Delete: The words "A01K 0254.png"

Devices for ballasting nets or net-lines, if not intended to roll over the ground substantially in trawl direction.

Sinkers forming part of specific net structures are found in groups for those structures.

Groundrope bobbins, dan-lenno bobbins.

Weighted lines, sink lines, drag-devices.

Illustrative example of subject matter classified in this group.

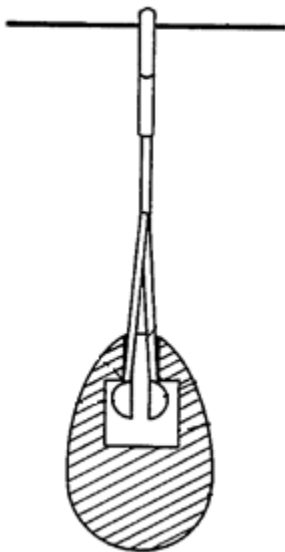

DATE: FEBRUARY 1, 2022

PROJECT RP0258

## References

### *Informative references*

Replace: The text associated with reference symbol A01K 95/00 with the updated text below.

Sinkers for angling	<a href="#">A01K95/00</a>
---------------------	---------------------------

## A01K 77/00

### Definition statement

Replace: The existing Definition statement with the updated one, including images, below.

Landing-nets, kesher, may be lightweight, collapsible, etc.

Handles for fishing-nets, may be extensible, collapsible, etc.

Devices may be useful for other purposes, e.g. egg retriever, swimming pool skinner, etc.

Details therefor, e.g. locking mechanisms, etc.

Illustrative example of subject matter classified in this group.



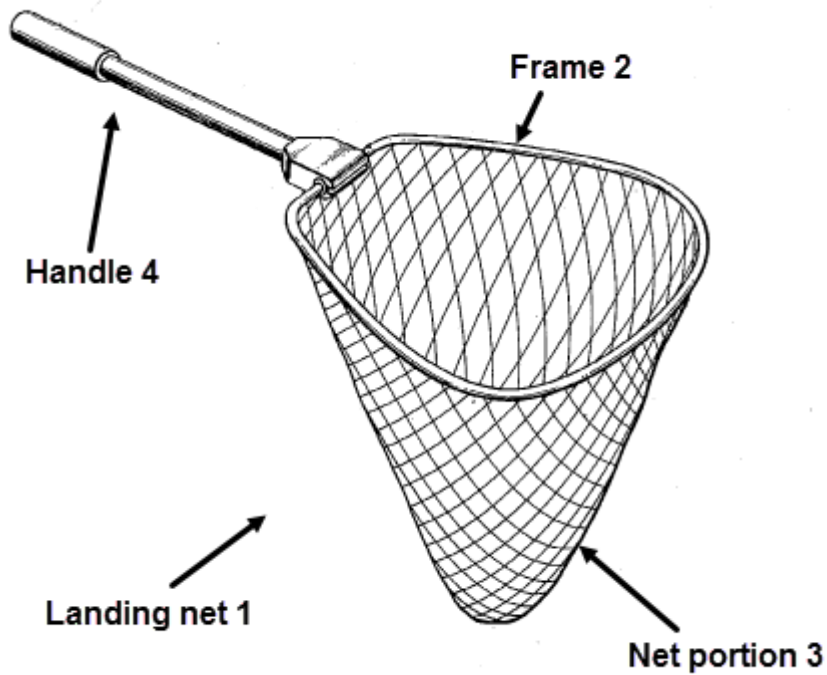

Landing net 1 has a frame 2, a net portion 3, and a handle 4.

## A01K 79/02

### Definition statement

Replace: The existing Definition statement with the updated one, including images, below.

Inducing movement into fish, shrimp, shellfish, etc., by electricity.

Inducing electrotaxy (directed swimming).

Stunning of fish and whales, by electricity.

Killing fish, before and after catching them, by means of electricity.

Special forms of appearance of electric current used, e.g. pulses.

Retrieving fish etc., by electrically induced movement.

DATE: FEBRUARY 1, 2022

PROJECT RP0258

Electric hooks for angling (stunning or killing biting fish).

Using water as conductor, for operating, e.g. echo-sounding.

A luring light may be involved or used alone in catching fish.

Attracting or scaring fish etc., by means other than electricity, e.g. by bait-spreading, air bubbles, shock waves, sound, etc.

Attracting or stunning fish.

Scaring sharks.

Illustrative example of subject matter classified in this group.

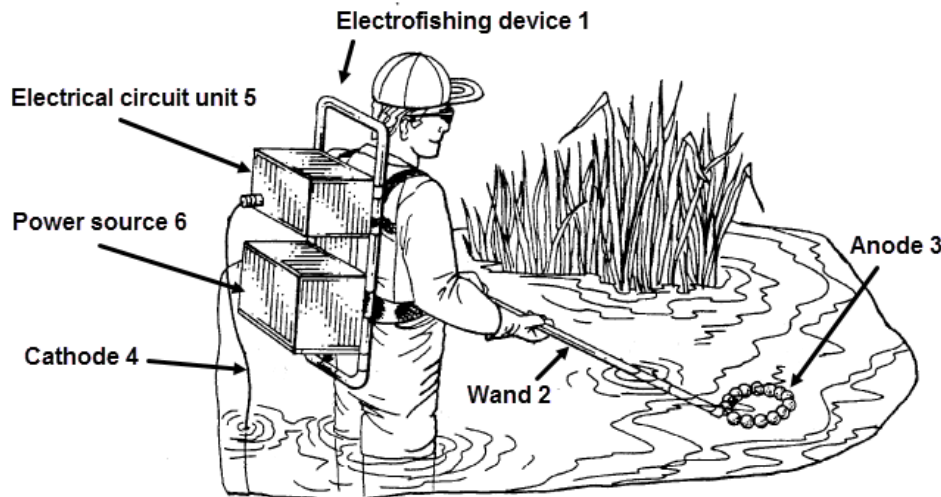

Electrofishing Device 1 has a wand 2, an anode 3, a cathode 4, an electrical circuit unit 5, and a power source 6, wherein the anode 3 and cathode 4 induce an electric field within a body of water and any fish within the electric field and which causes a state of petit mal in the fish where the fish lose consciousness and their muscles become flaccid so that the user may easily catch the fish for inspection, analysis, or other processing.

DATE: FEBRUARY 1, 2022

PROJECT RP0258

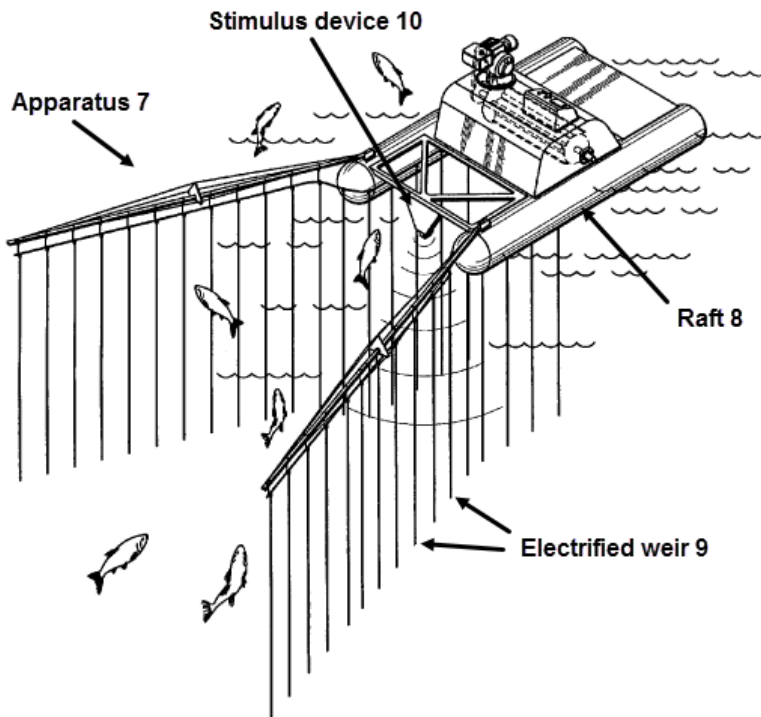

Apparatus 7 for nuisance carp control has a raft 8, an electrified weir 9, and a stimulus device 10, wherein the electrified weir 9 funnels the carp toward the raft 8 and the stimulus device 10 is an electrode that applies a stimulus to the water in the immediate vicinity thereof to cause carp to leap out of the water for collection on the raft 8.

## A01K 80/00

### Definition statement

Replace: The existing Definition statement with the updated one, including images, below.

Drags for catching organisms on or underground, other than normal dragnets having ground-chains or the like.

Devices for scraping mussels poles or oyster tiles etc., also for de-scaling.

Suction harvesting devices for ground-living organisms.

Plankton harvesters, also research purposes.

DATE: FEBRUARY 1, 2022

PROJECT RP0258

Marine specimen collectors or samplers.

Dredgers for clams, etc.

Crab catchers.

Clam diggers.

Sponge harvesting.

Oyster tongs.

Rakes, for treating oyster ground bottom surface.

Illustrative example of subject matter classified in this group.

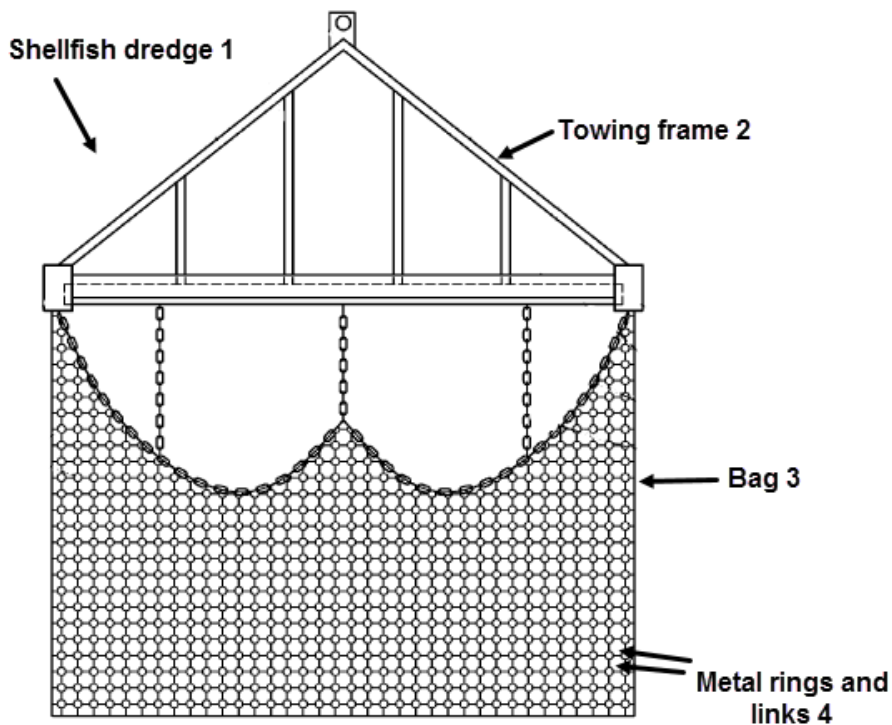

Shellfish dredge 1 has a towing frame 2 and a bag 3 comprising metal rings and links 4 which control the size of shellfish that the bag 3 is capable of holding, wherein the shellfish dredge 1 is towed along the ocean floor via the towing frame 2 which contacts the ocean floor to cause the shellfish to be collected in the bag 3.



Clam rake 5 is used to penetrate the sand in order to collect shellfish living in the sand.

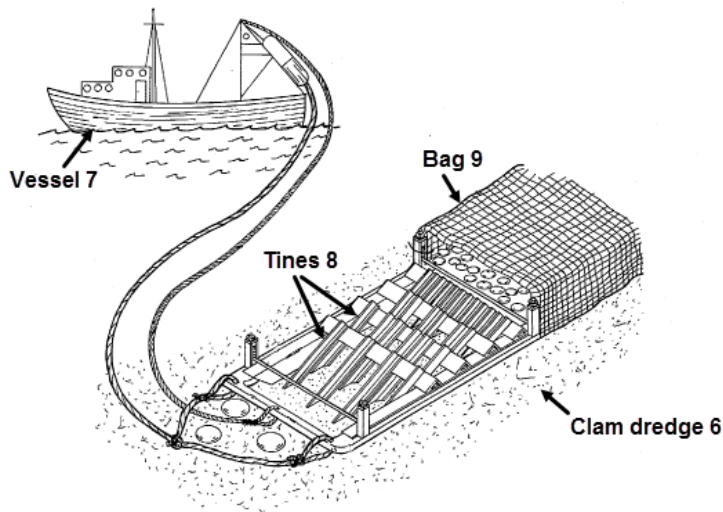

Clam dredge 6 is towed by vessel 7 along the ocean floor and has tines 8 and a bag 9, wherein the tines 8 cut into the ocean floor to dislodge the shellfish therefrom for collection in the bag 9.

DATE: FEBRUARY 1, 2022

PROJECT RP0258

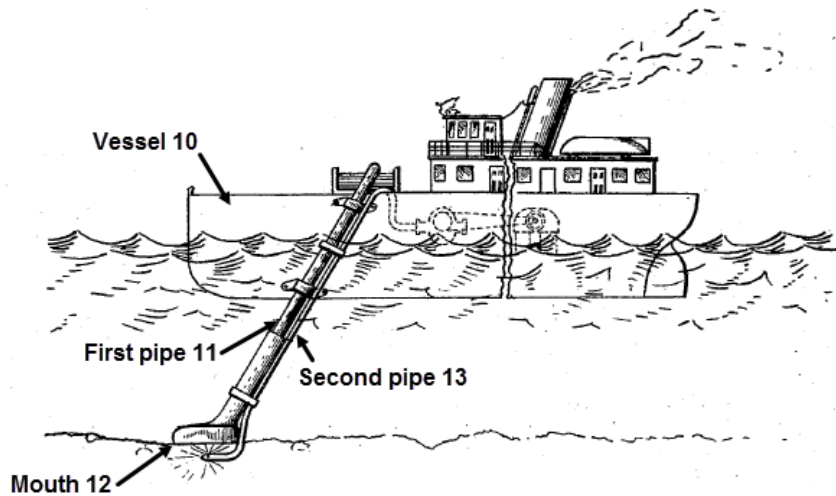

Vessel 10 has a first pipe 11 with a mouth 12 at a lower end thereof and a second pipe 13 which extends along the first pipe 11, wherein the second pipe 13 supplies compressed air to the first pipe 11 at the mouth 12 so as to both disrupt the bottom of the body of water adjacent the mouth 12 for dislodging the shellfish from the bottom of the body of water and cause a rising column of water to form within the first pipe 11 and mouth 12 which transports the shellfish to the vessel 10 via the first pipe 11.

## A01K 83/00

### Definition statement

Replace: The existing image with the updated image below.

Illustrative example of subject matter classified in this group.

DATE: FEBRUARY 1, 2022

PROJECT RP0258



## References

Delete: The Limiting references section and table.

Insert: The new Informative references section and table.

### Informative references

*Attention is drawn to the following places, which may be of interest for search:*

Making fish-hooks	<a href="#">B21F 45/12</a>
-------------------	----------------------------

## A01K 83/02

### Definition statement

Replace: The existing Definition statement with the updated one, including images, below.

Illustrative example of subject matter classified in this group.

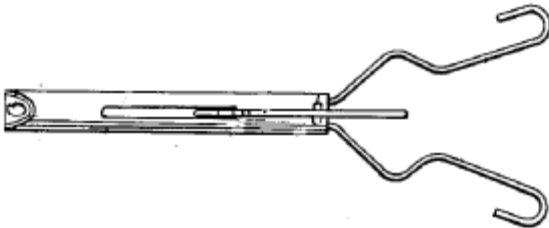



## A01K 83/04

### Definition statement

Replace: The existing Definition statement with the updated one, including images, below.

Illustrative example of subject matter classified in this group.

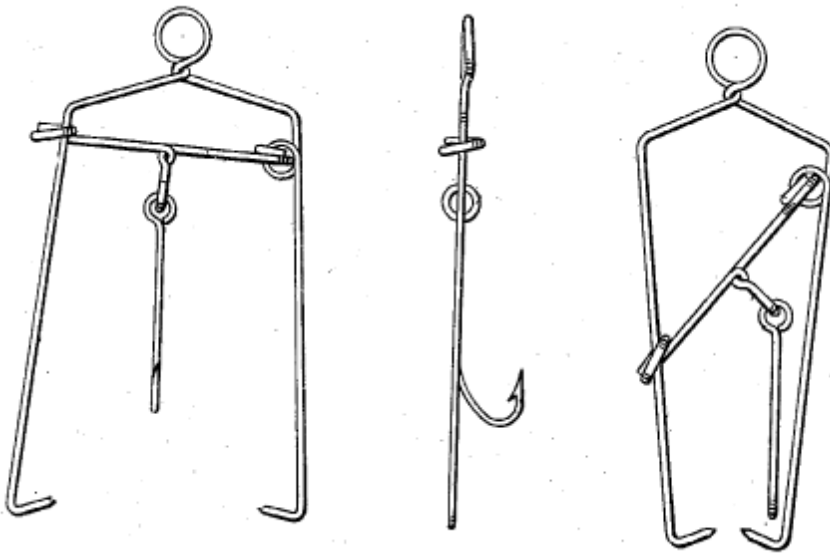

## A01K 83/06

### Definition statement

Replace: The existing Definition statement with the updated one, including images, below.

Illustrative example of subject matter classified in this group.

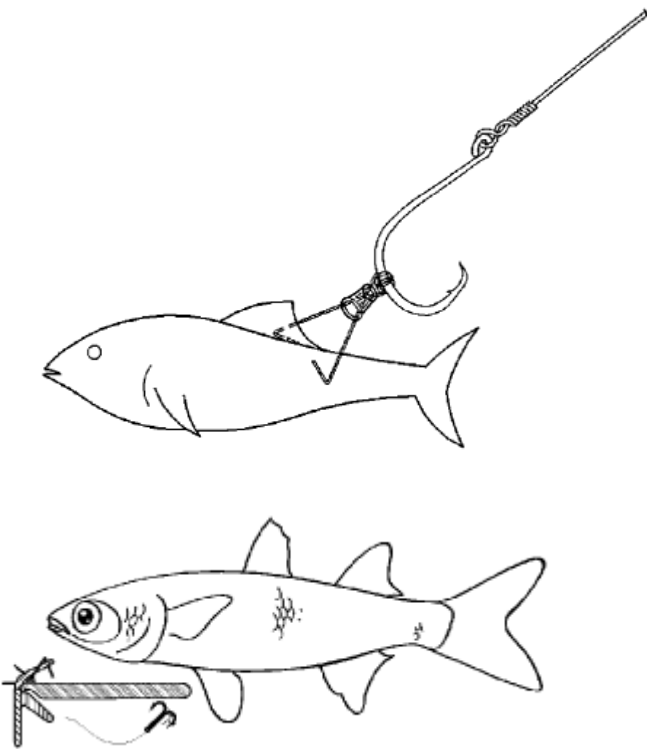

### References

Delete: The Limiting references section and table.

Insert: The new Informative references section and table below.

### Informative references

*Attention is drawn to the following places, which may be of interest for search:*

Baiting trotlines	A01K91/18
-------------------	-----------

Holding non-living edible bait on hooks
---

<a href="#">A01K97/045</a>
----------------------------

## A01K 85/00

### Definition statement

Replace: The existing Definition statement with the updated one, including images, below.

Artificial or imitation baits designed to attract fish and catch or aid in catching fish. Such lures frequently look like, or when moved through the water, take on the appearance of a live bait. Jigheads, soft lures, lures combining several features of subclasses.

Illustrative example of subject matter classified in this group.

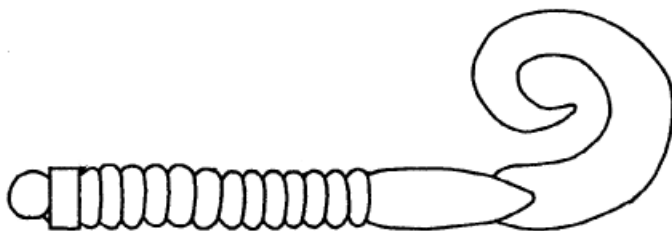
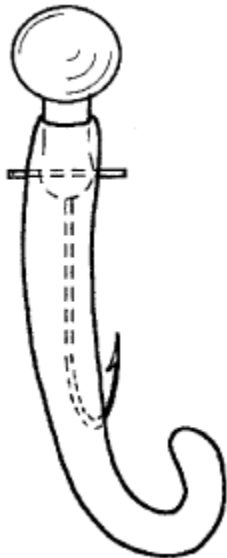

## References

Delete: The Limiting references section and table.

### Informative references:

Insert: The following NEW reference to the Informative references table.

Devices for laying ground-bait, e.g. chum dispensers	<a href="#">A01K97/02</a>
---	---------------------------

## A01K 85/005

### Definition statement

Replace: The existing Definition statement with the updated one, including images, below.

Illustrative example of subject matter classified in this group.

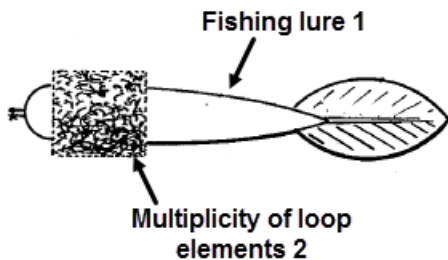

Fishing lure 1 has a multiplicity of loop elements 2, which are engageable with the teeth of a fish to thereby catch the fish.

DATE: FEBRUARY 1, 2022

PROJECT RP0258

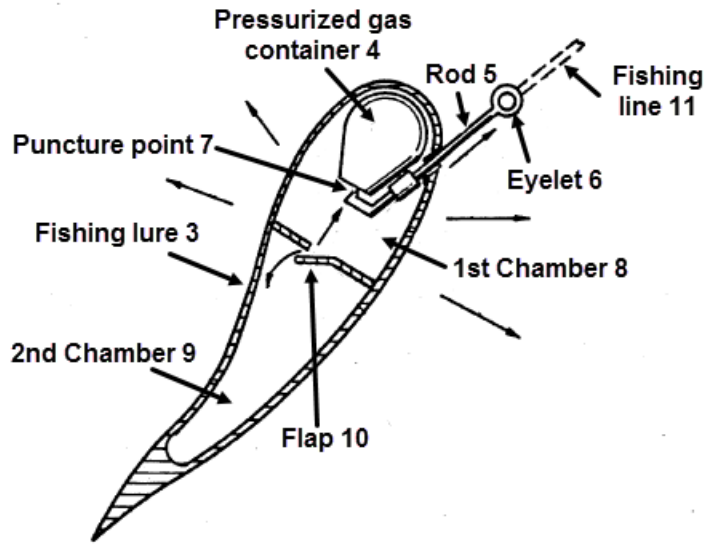

Fishing lure 3 has a pressurized gas container 4, a rod 5, an eyelet 6 at the upper end of the rod 5, a puncture point 7, a first chamber 8, a second chamber 9, a flap 10, and a fishing line 11 connected to the eyelet 6, wherein when a fish bites the fishing lure 3 and a pull is exerted on both the fishing lure 3 and the fishing line 11, puncture point 7 is driven into the pressurized gas container 4 to release gas into the first chamber 8 and the second chamber 9 to cause the fishing lure 3 to inflate and frictionally engage the inner walls of the fish to thereby catch the fish. In the event that pressurized gas leaks out of the first chamber 8, gas attempting to flow from the second chamber 9 to the first chamber 8 acts against flap 10 to seal the gas in the second chamber 9.

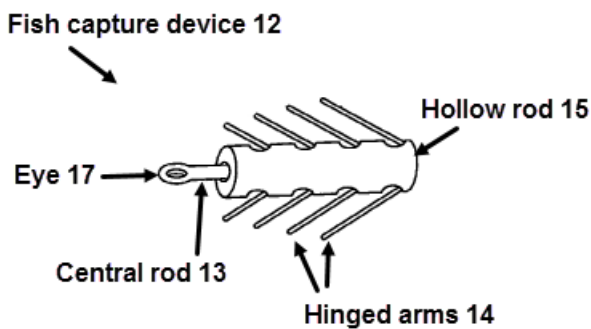

DATE: FEBRUARY 1, 2022

PROJECT RP0258

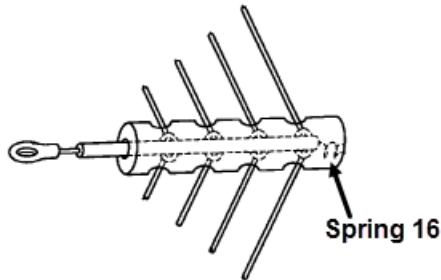

Fish capture device 12 has a central rod 13, hinged arms 14 attached to the central rod 13, a hollow rod 15, a spring 16 attached to one end of the central rod 13 for biasing the central rod 13 away from a closed end of the hollow rod 15 where the spring 16 is located, and an eye 17 attached to the other end of the central rod 13 for connection to a fishing line, wherein when a fish bites upon the fish capture device 12 and a pull is applied to the eye 17 by the fishing line, the central rod 13 and spring 16 cause the hinged arms 14 to move from a retracted position to an expanded position which results in the hinged arms 14 coming into contact with the interior of the mouth of the fish to thereby catch the fish.

## A01K 85/01

### Definition statement

Replace: The existing Definition statement with the updated one, including images, below.

Illustrative example of subject matter classified in this group.

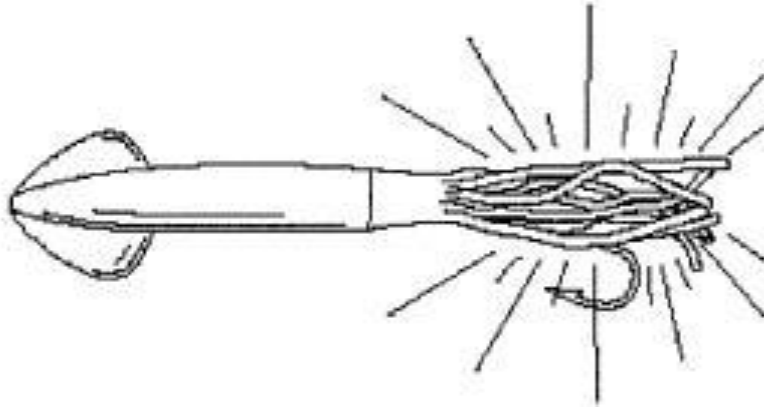

## References

Delete: The Limiting references section and table.

Insert: The new Informative references section and table.

### Informative references

*Attention is drawn to the following places, which may be of interest for search:*

Attracting fish with lighting or sound device not attached to fishing line
--

<a href="#">A01K97/02</a>
---------------------------

## A01K 85/02

### Definition statement

Replace: The existing Definition statement with the updated one, including images, below.

Illustrative example of subject matter classified in this group.

DATE: FEBRUARY 1, 2022

PROJECT RP0258

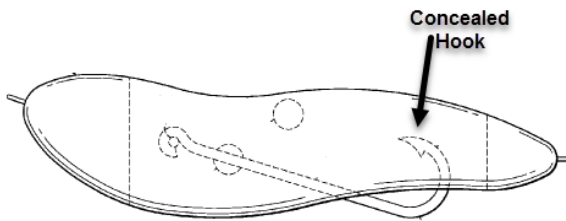

## A01K 85/08

### Definition statement

Replace: The existing Definition statement with the updated one, including images, below.

Illustrative example of subject matter classified in this group.

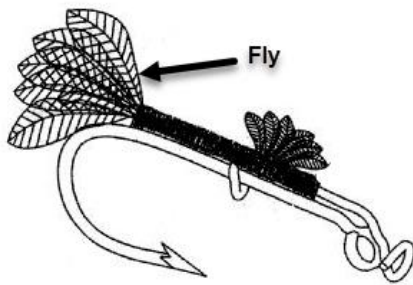



## A01K 85/10

### Definition statement

Replace: The existing Definition statement with the updated one, including images, below.

Illustrative example of subject matter classified in this group.

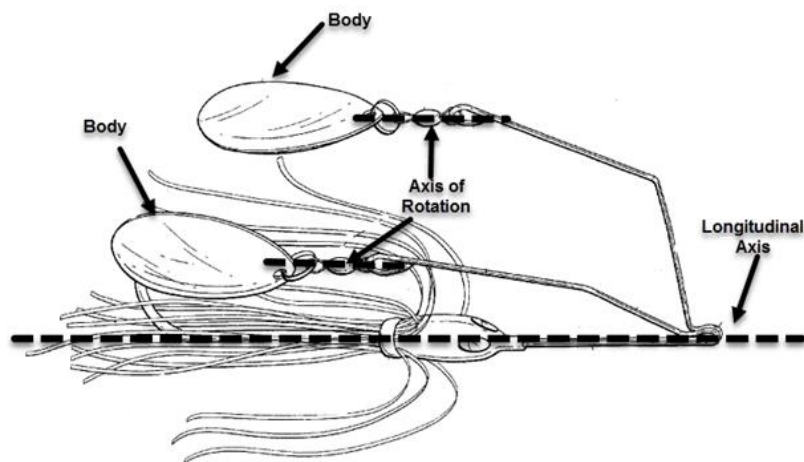

## A01K 85/12

### Definition statement

Replace: The existing Definition statement with the updated one, including images, below.

Illustrative example of subject matter classified in this group.

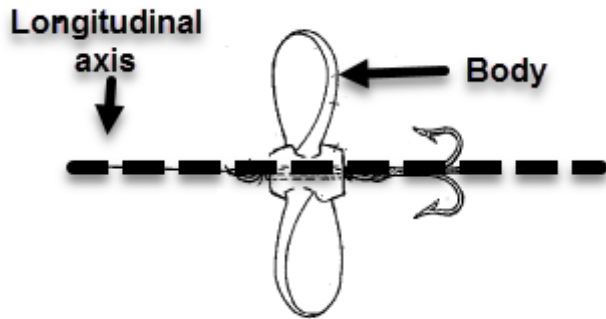
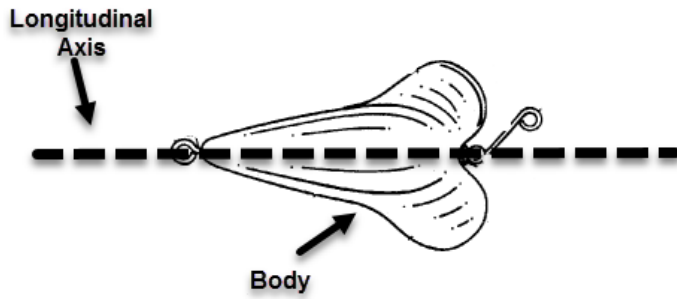

## A01K 85/14

### Definition statement

Replace: The existing Definition statement with the updated one, including images, below.

Illustrative example of subject matter classified in this group.

DATE: FEBRUARY 1, 2022

PROJECT RP0258

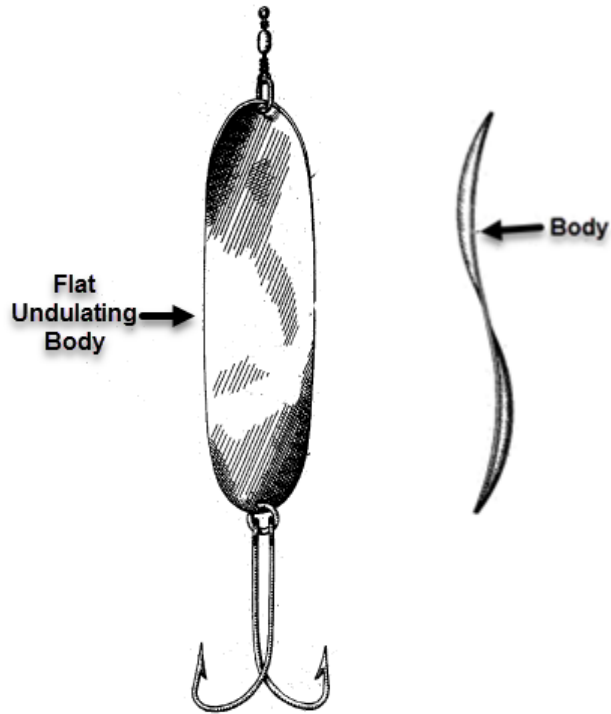

## A01K 85/18

### Definition statement

Replace: The existing Definition statement with the updated one, including images, below.

Illustrative example of subject matter classified in this group.

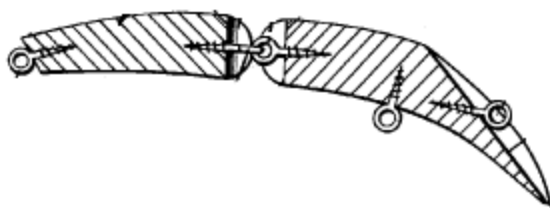
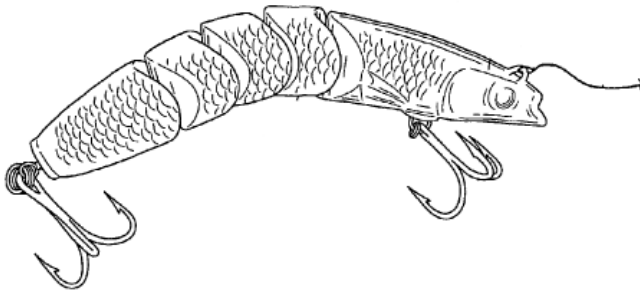

## A01K 87/00

### Definition statement

Replace: The existing Definition statement with the updated one, including images, below.

Illustrative example of subject matter classified in this group.



## A01K 87/005

### Definition statement

Replace: The existing Definition statement with the updated one, including images, below.

Illustrative example of subject matter classified in this group.

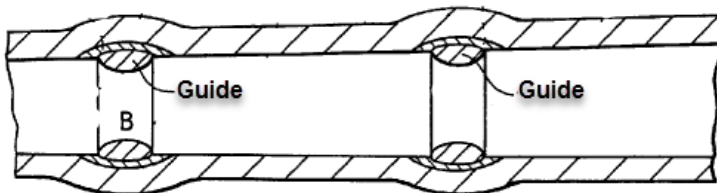

## A01K 87/025

### Definition statement

Replace: The existing Definition statement with the updated one, including images, below.

Illustrative example of subject matter classified in this group.

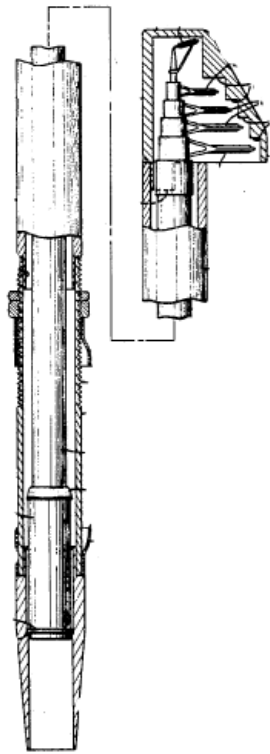

## A01K 87/08

### Definition statement

Replace: The existing Definition statement with the updated one, including images, below.

Illustrative example of subject matter classified in this group.

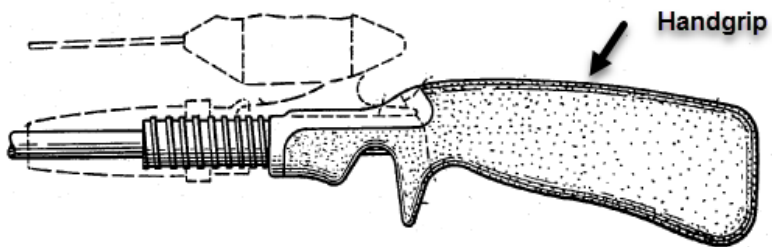

## **A01K87/085**

### **Definition statement**

Replace: The existing image with the updated one below.

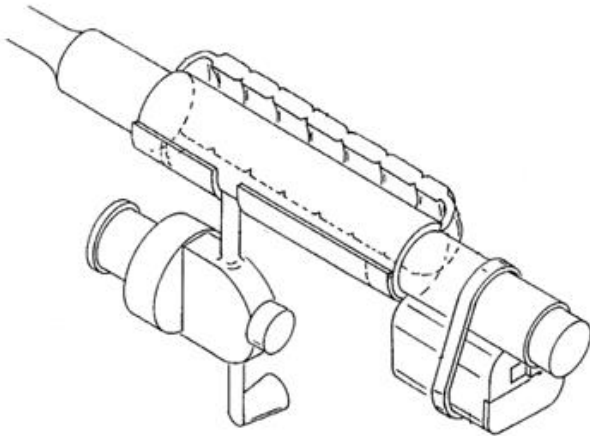



## A01K89/0102

### Definition statement

Replace: The existing Definition statement with the updated one, including images, below.

Subject matter wherein the frame of the reel includes a cover substantially enclosing the spool.

Illustrative example of subject matter classified in this group.

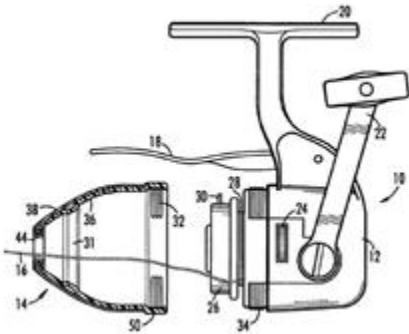

### References

Delete: The Limiting references section and table.

Insert: The new Informative references section and table.

#### Informative references

Attention is drawn to the following places, which may be of interest for search:

Brake devices for closed face reels
-------------------------------------

<a href="#">A01K89/0275</a>
-----------------------------

DATE: FEBRUARY 1, 2022

PROJECT RP0258

## A01K91/10

### References

Delete: The Limiting references section and table.

Insert: The new Informative references section and table.

#### Informative references

*Attention is drawn to the following places, which may be of interest for search:*

Supports for rods with automatic hook setting	<a href="#">A01K97/11</a>
---	---------------------------

## A01K97/00

### References:

Delete: The following row from the Limiting references table.

#### Limiting references:

*This place does not cover:*

Fish finders	G01S 15/96
--------------	------------

Insert: The following new row to the Informative references table.

#### Informative references:

*Attention is drawn to the following places, which may be of interest for search:*

Sonar systems for locating fish	<a href="#">G01S 15/96</a>
---------------------------------	----------------------------

## A01K97/01

### Definition statement

Replace: The existing Definition statement with the updated one, including images, below.

Illustrative example of subject matter classified in this group.

DATE: FEBRUARY 1, 2022

PROJECT RP0258

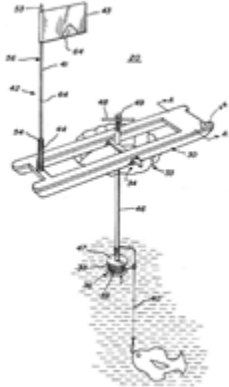

## References

Delete: The Limiting references section and table.

Insert: The new Informative references section and table.

### Informative references

*Attention is drawn to the following places, which may be of interest for search:*

Fishing, hunting huts or the like	<a href="#">E04H15/001</a>
Special methods or apparatus for drilling	<a href="#">E21B7/00</a>

## A01K97/02

### Definition statement

Replace: The existing Definition statement with the updated one, including images, below.

Illustrative examples of subject matter classified in this group.

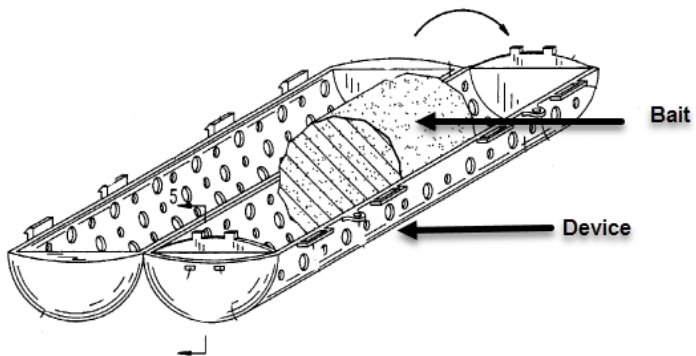
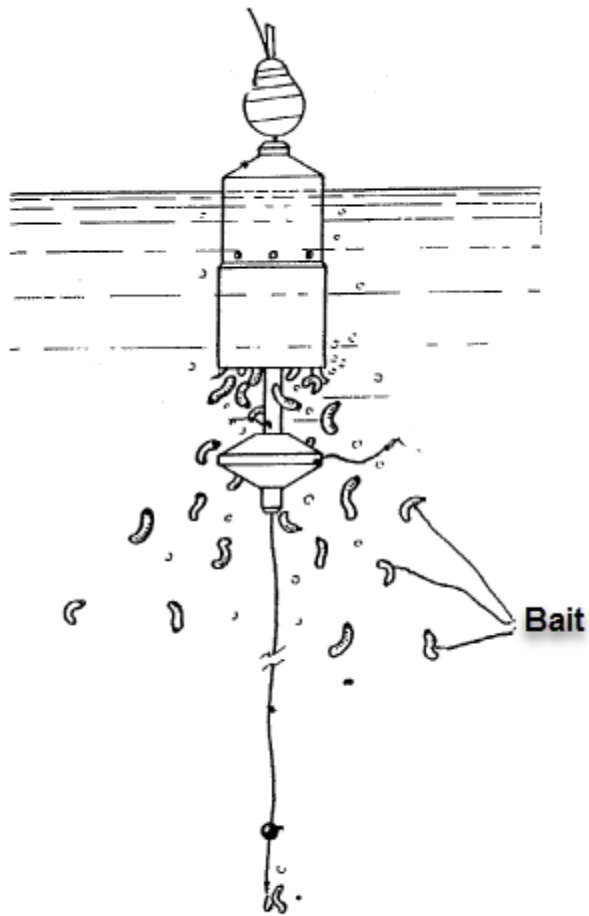

DATE: FEBRUARY 1, 2022

PROJECT RP0258

**References****Informative references**Insert: The following new rows to the Informative references table.

Edible baits or other oral forms for animals	<a href="#">A61K 9/0056</a>
Artificial baits	<a href="#">A01K 85/00</a>
Preparation of bait; Ingredients	<a href="#">A01K 97/045</a>

**A01K97/045****References**Delete: The Limiting references section and table.Insert: The new Informative references section and table.**Informative references***Attention is drawn to the following places, which may be of interest for search:*

Holding bait on hooks	<a href="#">A01K83/06</a>
Baiting trotlines	<a href="#">A01K91/18</a>

DATE: FEBRUARY 1, 2022

PROJECT RP0258

## A01K 97/06

### References

#### Informative references:

Insert: The following new row to the informative references table.

Fishing rod with attached hook or tackle holders	A01K 87/009
--	-------------

CPC NOTICE OF CHANGES 1252

DATE: FEBRUARY 1, 2022

PROJECT RP0258

3. REVISION CONCORDANCE LIST (RCL)

<u>Type*</u>	<u>From CPC Symbol (existing)</u>	<u>To CPC Symbol(s)</u>
C	A01K 73/02	A01K 73/02, A01K 73/063, A01K 73/067
C	A01K 73/025	A01K 73/025, A01K 73/063, A01K 73/067
C	A01K 73/04	A01K 73/04, A01K 73/063, A01K 73/067
C	A01K 73/045	A01K 73/045, A01K 73/063, A01K 73/067
C	A01K 73/05	A01K 73/05, A01K 73/063, A01K 73/067
C	A01K 73/053	A01K 73/053, A01K 73/063, A01K 73/067
C	A01K 73/06	A01K 73/06, A01K 73/063, A01K 73/067
C	A01K 73/10	A01K 73/10, A01K 73/063, A01K 73/067
C	A01K 75/00	A01K 75/00, A01K 75/005
C	A01K 77/00	A01K 77/00, A01K 77/005
C	A01K 79/02	A01K 79/02, A01K 73/067
C	A01K 80/00	A01K 80/00, A01K 80/005
C	A01K 83/00	A01K 83/00, A01K 83/066, A01K 83/067, A01K 83/069
C	A01K 83/02	A01K 83/02, A01K 83/025
C	A01K 83/04	A01K 83/04, A01K 83/045
C	A01K 83/06	A01K 83/06, A01K 83/061, A01K 83/063, A01K 83/064
C	A01K 85/00	A01K 85/00, A01K 85/011, A01K 85/012, A01K 85/013, A01K 85/019, A01K 85/026, A01K 85/027, A01K 85/028, A01K 85/029, A01K 85/1803, A01K 85/1807, A01K 85/1811, A01K 85/1813, A01K 85/1817, A01K 85/1821, A01K 85/1823, A01K 85/1827, A01K 85/1831, A01K 85/1833, A01K 85/1837, A01K 85/1841, A01K 85/1843, A01K 85/1847, A01K 85/1851, A01K 85/1853, A01K 85/1857, A01K 85/1861, A01K 85/1863, A01K 85/1867, A01K 85/1871, A01K 85/1873, A01K 85/1877, A01K 85/1881, A01K 85/1883, A01K 85/1887, A01K 85/1891, A01K 85/1893, A01K 85/1897
C	A01K 85/005	A01K 85/005, A01K 85/011, A01K 85/012, A01K 85/013, A01K 85/019, A01K 85/026, A01K 85/027, A01K 85/028, A01K 85/029, A01K 85/1803, A01K 85/1807, A01K 85/1811, A01K 85/1813, A01K 85/1817, A01K 85/1821, A01K 85/1823, A01K 85/1827, A01K 85/1831, A01K 85/1833, A01K 85/1837, A01K 85/1841, A01K 85/1843, A01K 85/1847, A01K 85/1851, A01K 85/1853, A01K 85/1857, A01K 85/1861, A01K 85/1863, A01K 85/1867, A01K 85/1871, A01K 85/1873, A01K 85/1877, A01K 85/1881, A01K 85/1883, A01K 85/1887, A01K 85/1891, A01K 85/1893, A01K 85/1897
C	A01K 85/01	A01K 85/01, A01K 85/011, A01K 85/012, A01K 85/013, A01K 85/015, A01K 85/017, A01K 85/018, A01K 85/019, A01K 85/026, A01K 85/027, A01K 85/028, A01K 85/029, A01K 85/1803, A01K 85/1807, A01K 85/1811, A01K 85/1813, A01K 85/1817, A01K 85/1821, A01K 85/1823, A01K 85/1827, A01K 85/1831, A01K 85/1833, A01K 85/1837, A01K 85/1841, A01K 85/1843, A01K 85/1847, A01K 85/1851, A01K 85/1853, A01K 85/1857, A01K 85/1861, A01K 85/1863, A01K 85/1867, A01K 85/1871, A01K 85/1873, A01K 85/1877, A01K 85/1881, A01K 85/1883, A01K 85/1887, A01K 85/1891, A01K 85/1893, A01K 85/1897

CPC NOTICE OF CHANGES 1252

DATE: FEBRUARY 1, 2022

PROJECT RP0258

<b>Type*</b>	<b><u>From CPC Symbol (existing)</u></b>	<b><u>To CPC Symbol(s)</u></b>
C	A01K 85/02	A01K 85/02, A01K 85/021, A01K 85/022, A01K 85/023, A01K 85/024, A01K 85/025, A01K 85/011, A01K 85/012, A01K 85/013, A01K 85/019, A01K 85/026, A01K 85/027, A01K 85/028, A01K 85/029, A01K 85/1803, A01K 85/1807, A01K 85/1811, A01K 85/1813, A01K 85/1817, A01K 85/1821, A01K 85/1823, A01K 85/1827, A01K 85/1831, A01K 85/1833, A01K 85/1837, A01K 85/1841, A01K 85/1843, A01K 85/1847, A01K 85/1851, A01K 85/1853, A01K 85/1857, A01K 85/1861, A01K 85/1863, A01K 85/1867, A01K 85/1871, A01K 85/1873, A01K 85/1877, A01K 85/1881, A01K 85/1883, A01K 85/1887, A01K 85/1887, A01K 85/1891, A01K 85/1893, A01K 85/1897
C	A01K 85/08	A01K 85/08, A01K 85/011, A01K 85/012, A01K 85/013, A01K 85/019, A01K 85/026, A01K 85/027, A01K 85/028, A01K 85/029, A01K 85/1803, A01K 85/1807, A01K 85/1811, A01K 85/1813, A01K 85/1817, A01K 85/1821, A01K 85/1823, A01K 85/1827, A01K 85/1831, A01K 85/1833, A01K 85/1837, A01K 85/1841, A01K 85/1843, A01K 85/1847, A01K 85/1851, A01K 85/1853, A01K 85/1857, A01K 85/1861, A01K 85/1863, A01K 85/1867, A01K 85/1871, A01K 85/1873, A01K 85/1877, A01K 85/1881, A01K 85/1883, A01K 85/1887, A01K 85/1891, A01K 85/1893, A01K 85/1897
C	A01K 85/10	A01K 85/10, A01K 85/011, A01K 85/012, A01K 85/013, A01K 85/019, A01K 85/026, A01K 85/027, A01K 85/028, A01K 85/029, A01K 85/1803, A01K 85/1807, A01K 85/1811, A01K 85/1813, A01K 85/1817, A01K 85/1821, A01K 85/1823, A01K 85/1827, A01K 85/1831, A01K 85/1833, A01K 85/1837, A01K 85/1841, A01K 85/1843, A01K 85/1847, A01K 85/1851, A01K 85/1853, A01K 85/1857, A01K 85/1861, A01K 85/1863, A01K 85/1867, A01K 85/1871, A01K 85/1873, A01K 85/1877, A01K 85/1881, A01K 85/1883, A01K 85/1887, A01K 85/1891, A01K 85/1893, A01K 85/1897
C	A01K 85/12	A01K 85/12, A01K 85/122, A01K 85/125, A01K 85/128, A01K 85/011, A01K 85/012, A01K 85/013, A01K 85/019, A01K 85/026, A01K 85/027, A01K 85/028, A01K 85/029, A01K 85/1803, A01K 85/1807, A01K 85/1811, A01K 85/1813, A01K 85/1817, A01K 85/1821, A01K 85/1823, A01K 85/1827, A01K 85/1831, A01K 85/1833, A01K 85/1837, A01K 85/1841, A01K 85/1843, A01K 85/1847, A01K 85/1851, A01K 85/1853, A01K 85/1857, A01K 85/1861, A01K 85/1863, A01K 85/1867, A01K 85/1871, A01K 85/1873, A01K 85/1877, A01K 85/1881, A01K 85/1883, A01K 85/1887, A01K 85/1891, A01K 85/1893, A01K 85/1897
C	A01K 85/14	A01K 85/14, A01K 85/143, A01K 85/147, A01K 85/011, A01K 85/012, A01K 85/013, A01K 85/019, A01K 85/026, A01K 85/027, A01K 85/028, A01K 85/029, A01K 85/1803, A01K 85/1807, A01K 85/1811, A01K 85/1813, A01K 85/1817, A01K 85/1821, A01K 85/1823, A01K 85/1827, A01K 85/1831, A01K 85/1833, A01K 85/1837, A01K 85/1841, A01K 85/1843, A01K 85/1847, A01K 85/1851, A01K 85/1853, A01K 85/1857, A01K 85/1861, A01K 85/1863, A01K 85/1867, A01K 85/1871, A01K 85/1873, A01K 85/1877, A01K 85/1881, A01K 85/1883, A01K 85/1887, A01K 85/1891, A01K 85/1893, A01K 85/1897



CPC NOTICE OF CHANGES 1252

DATE: FEBRUARY 1, 2022

PROJECT RP0258

<b>Type*</b>	<b>From CPC Symbol (existing)</b>	<b>To CPC Symbol(s)</b>
C	A01K 85/16	A01K 85/16, A01K 85/011, A01K 85/012, A01K 85/013, A01K 85/019, A01K 85/026, A01K 85/027, A01K 85/028, A01K 85/029, A01K 85/1803, A01K 85/1807, A01K 85/1811, A01K 85/1813, A01K 85/1817, A01K 85/1821, A01K 85/1823, A01K 85/1827, A01K 85/1831, A01K 85/1833, A01K 85/1837, A01K 85/1841, A01K 85/1843, A01K 85/1847, A01K 85/1851, A01K 85/1853, A01K 85/1857, A01K 85/1861, A01K 85/1863, A01K 85/1867, A01K 85/1871, A01K 85/1873, A01K 85/1877, A01K 85/1881, A01K 85/1883, A01K 85/1887, A01K 85/1891, A01K 85/1893, A01K 85/1897
C	A01K 85/18	A01K 85/18, A01K 85/011, A01K 85/012, A01K 85/013, A01K 85/019, A01K 85/026, A01K 85/027, A01K 85/028, A01K 85/029, A01K 85/1803, A01K 85/1807, A01K 85/1811, A01K 85/1813, A01K 85/1817, A01K 85/1821, A01K 85/1823, A01K 85/1827, A01K 85/1831, A01K 85/1833, A01K 85/1837, A01K 85/1841, A01K 85/1843, A01K 85/1847, A01K 85/1851, A01K 85/1853, A01K 85/1857, A01K 85/1861, A01K 85/1863, A01K 85/1867, A01K 85/1871, A01K 85/1873, A01K 85/1877, A01K 85/1881, A01K 85/1883, A01K 85/1887, A01K 85/1891, A01K 85/1893, A01K 85/1897
C	A01K 87/00	A01K 87/00, A01K 87/008, A01K 87/009
C	A01K 87/002	A01K 87/002, A01K 87/008, A01K 87/009
C	A01K 87/005	A01K 87/005, A01K 87/008, A01K 87/009
C	A01K 87/02	A01K 87/02, A01K 87/008, A01K 87/009
C	A01K 87/025	A01K 87/025, A01K 87/008, A01K 87/009
C	A01K 87/04	A01K 87/04, A01K 87/008, A01K 87/009
C	A01K 87/06	A01K 87/06, A01K 87/008, A01K 87/009
C	A01K 87/08	A01K 87/08, A01K 87/008, A01K 87/009
C	A01K 87/085	A01K 87/085, A01K 87/008, A01K 87/009
C	A01K 97/06	A01K 97/06, A01K 87/009

\* C = entries with modified file scope where reclassification of documents from the entries is involved; Q = new entries which are firstly populated with documents via administrative transfers from deleted (D) entries. Afterwards, the transferred documents into the Q entry will either stay or be moved to more appropriate entries, as determined by intellectual reclassification; D = deleted entries; F = frozen entries will be deleted once reclassification of documents from the entries is completed.

NOTES:

- Only C, D, F, and Q type entries are included in the table above.
- When multiple symbols are included in the “To” column, do not use ranges of symbols.
- For administrative transfer of documents, the following text should be used: “< administrative transfer to XX>”, “<administrative transfer to XX and YY simultaneously>”, or “<administrative transfer to XX, YY, ...and ZZ simultaneously>” when administrative transfer of the same documents is to more than one place.
- Administrative transfer to main trunk groups is assumed to be the source allocation type, unless otherwise indicated.
- Administrative transfer to 2000/Y series groups is assumed to be “additional information”.
- If needed, instructions for allocation type should be indicated within the angle brackets using the abbreviations “ADD” or “INV”: <administrative transfer to XX ADD>, <administrative transfer to XX INV>, or < administrative transfer to XX ADD, YY INV, ... and ZZ ADD simultaneously>.
- In certain situations, the “D” entries of 2000-series or Y-series groups may not require a destination (“To”) symbol, however it is required to specify “<no transfer>” in the “To” column for such cases.
- RCL is not needed for finalisation projects.

CPC NOTICE OF CHANGES 1252

DATE: FEBRUARY 1, 2022

PROJECT RP0258

4. CHANGES TO THE CPC-TO-IPC CONCORDANCE LIST (CICL)

<u>CPC</u>	<u>IPC</u>	<u>Action*</u>
A01K 73/063	A01K 73/02	NEW
A01K 73/067	A01K 73/02	NEW
A01K 75/005	A01K 75/00	NEW
A01K 77/005	A01K 77/00	NEW
A01K 80/005	A01K 80/00	NEW
A01K 83/025	A01K 83/02	NEW
A01K 83/045	A01K 83/04	NEW
A01K 83/061	A01K 83/06	NEW
A01K 83/063	A01K 83/06	NEW
A01K 83/064	A01K 83/06	NEW
A01K 83/066	A01K 83/00	NEW
A01K 83/067	A01K 83/00	NEW
A01K 83/069	A01K 83/00	NEW
A01K 85/011	A01K 85/01	NEW
A01K 85/012	A01K 85/01	NEW
A01K 85/013	A01K 85/01	NEW
A01K 85/015	A01K 85/01	NEW
A01K 85/017	A01K 85/01	NEW
A01K 85/018	A01K 85/01	NEW
A01K 85/019	A01K 85/01	NEW
A01K 85/021	A01K 85/02	NEW
A01K 85/022	A01K 85/02	NEW
A01K 85/023	A01K 85/02	NEW
A01K 85/024	A01K 85/02	NEW
A01K 85/025	A01K 85/02	NEW
A01K 85/026	A01K 85/00	NEW
A01K 85/027	A01K 85/00	NEW
A01K 85/028	A01K 85/00	NEW
A01K 85/029	A01K 85/00	NEW
A01K 85/122	A01K 85/12	NEW
A01K 85/125	A01K 85/12	NEW
A01K 85/128	A01K 85/12	NEW
A01K 85/143	A01K 85/14	NEW
A01K 85/147	A01K 85/14	NEW
A01K 85/1803	A01K 85/00	NEW
A01K 85/1807	A01K 85/00	NEW
A01K 85/1811	A01K 85/00	NEW
A01K 85/1813	A01K 85/00	NEW
A01K 85/1817	A01K 85/00	NEW

CPC NOTICE OF CHANGES 1252

DATE: FEBRUARY 1, 2022

PROJECT RP0258

<u>CPC</u>	<u>IPC</u>	<u>Action*</u>
A01K 85/1821	A01K 85/00	NEW
A01K 85/1823	A01K 85/00	NEW
A01K 85/1827	A01K 85/00	NEW
A01K 85/1831	A01K 85/00	NEW
A01K 85/1833	A01K 85/00	NEW
A01K 85/1837	A01K 85/00	NEW
A01K 85/1841	A01K 85/00	NEW
A01K 85/1843	A01K 85/00	NEW
A01K 85/1847	A01K 85/00	NEW
A01K 85/1851	A01K 85/00	NEW
A01K 85/1853	A01K 85/00	NEW
A01K 85/1857	A01K 85/00	NEW
A01K 85/1861	A01K 85/00	NEW
A01K 85/1863	A01K 85/00	NEW
A01K 85/1867	A01K 85/00	NEW
A01K 85/1871	A01K 85/00	NEW
A01K 85/1873	A01K 85/00	NEW
A01K 85/1877	A01K 85/00	NEW
A01K 85/1881	A01K 85/00	NEW
A01K 85/1883	A01K 85/00	NEW
A01K 85/1887	A01K 85/00	NEW
A01K 85/1891	A01K 85/00	NEW
A01K 85/1893	A01K 85/00	NEW
A01K 85/1897	A01K 85/00	NEW
A01K 87/008	A01K 87/00	NEW
A01K 87/009	A01K 87/00	NEW

\* Action column:

- For an (N) or (Q) entry, provide an IPC symbol and complete the Action column with “NEW.”
- For an existing CPC main trunk entry or indexing entry where the existing IPC symbol needs to be changed, provide an updated IPC symbol and complete the Action column with “UPDATED.”
- For a (D) CPC entry or indexing entry complete the Action column with “DELETE.” IPC symbol does not need to be included in the IPC column.
- For an (N) 2000 series CPC entry which is positioned within the main trunk scheme (breakdown code) provide an IPC symbol and complete the action column with “NEW”.
- For an (N) 2000 series CPC entry positioned at the end of the CPC scheme (orthogonal code), with no IPC equivalent, complete the IPC column with “CPCONLY” and complete the action column with “NEW”.

NOTES:

- F symbols are not included in the CICL table above.
- T and M symbols are not included in the CICL table above unless a change to the existing IPC is desired.